

185 WATTS

NO MINIMUM ORDER REQUIRED

REL-185 SERIES

OUTPUT SPECIFICATIONS

Features

- RoHS Compliant
- Advanced SMT Design
- Compact 4.2" X 7.0" X 1.5" Size
- 2 Year Warranty
- Fits 1U Application
- One to Four Outputs
- EN 60950-1 ITE Certification
- EN 60601-1 Medical Certification
- Harmonic Current per EN 61000-3-2
- Class B Emissions Per EN 55011/22
- EMC to EN 61000-6-2 & EN 60601-1-2
- Optional Chassis & Cover
- Universal 85-264 VAC Input
- High Efficiency



OPEN FRAME



CHASSIS/COVER

Total Output Power at 135W Convection Cooled 50c	185W 300 LMF Forced Air
Output Voltage	Output 1: +/-0.5%
Centering	Output 2: +/-5.0%
	Output 3: +/-5.0%
	Output 4: +/-5.0% (All outputs at 50% load)
Source Regulation	Outputs 1-4: 0.5%
Load Regulation	Output 1: 0.5% (10-100% Load Change)
	Output 2: 5.0% (10-100% Load Change)
	(4001,4,5,2001) 10.0% (20-100% Load Change)
	(4002,4003) 15.0% (20-100% Load Change)
	Output 3: 5.0% (10-100% Load Change)
	Output 4: 5.0% (10-100% Load Change)
Cross Regulation	Output 2-4: 6.0%
Output Voltage Adjust Range	Output 1: 95%-105%
Output Noise	Outputs 1-4: 1.0%
Turn On Overshoot	None
Transient Response	Outputs 1-4:
Voltage Deviation	5.0%
Recovery Time	500 MicroS
Load Change	50% To 100%
Output Overvoltage Protection	Output 1: 110% to 150%
Output Overpower Protection	110-160% rated Pout, cycle on/off, auto recovery
Hold Up Time	16 mS Min, Full Power 85 V Input
Start Up Time	5 Second, 120V Input

INPUT SPECIFICATIONS

Source Voltage	85-264 Voltage AC
Frequency Range	47-63 Hz
Peak Inrush Current	40A
Efficiency	.82% Typ., Full Power, 230V (Varies by model)
Power Factor	0.95(Full Power, 230V)

ENVIRONMENTAL SPECIFICATIONS

Ambient Operating Temperature Range	0°C to +70°C Derating: See Power Rating Chart
Ambient Storage Temp. Range	-40°C to +85°C
Temperature Coefficient	Outputs 1-4: 0.02%/°C

ELECTROMAGNETIC COMPATIBILITY			GENERAL SPECIFICATIONS	
Electrostatic Discharge	EN 61000-4-2	+/-8kV Contact Discharge +/-8kV Air Discharge	Dielectric Strength Reinforced Insulation 5656 VDC, Primary to Secondary, 1 Sec. Basic Insulation 2121 VDC, Primary to Ground, 1 Sec. Operational Insulation 707 VDC, Secondary to Ground, 1 Sec. Leakage Current <300 ÅµA Earth Leakage Current Power Fail Signal Logic low with input power failure 10mS minimum prior to output 1 dropping 1% Remote on/off (optional) Contact closure shuts off all outputs Remote Sense 250mV compensation of output cable losses Mean Time Between Failures 100,000 Hours min., MIL-HDBK-217F, 25°C, GB Weight 1.70 Lbs. Open Frame 2.70 Lbs. Chassis and Cover	
Radiated Electro-magnetic Field	EN 61000-4-3	80MHZ-2.5GHZ, 10V/m, 80% AM		
EFT/Bursts	EN 61000-4-4	+/-2kV		
Surges	EN 61000-4-5	+/-1 kV Common Mode +/-2 kV Differential Mode		
Conducted Immunity	EN 61000-4-6	.15-80MHZ., 10V, 80% AM	Remote on/off (optional) Contact closure shuts off all outputs Remote Sense 250mV compensation of output cable losses Mean Time Between Failures 100,000 Hours min., MIL-HDBK-217F, 25°C, GB Weight 1.70 Lbs. Open Frame 2.70 Lbs. Chassis and Cover	
Voltage Dips and Interruptions	EN 61000-4-11	30% Dip, 500ms 95% Dip, 10ms 60% Reduction, 1s (Criteria B) 95% Reduction, 5000ms		
Radiated Emissions	EN 55011/22	Class B		
Conducted Emissions	EN 55011/22	Class B		
Harmonic Current Emissions	EN 61000-3-2		Remote on/off (optional) Contact closure shuts off all outputs Remote Sense 250mV compensation of output cable losses Mean Time Between Failures 100,000 Hours min., MIL-HDBK-217F, 25°C, GB Weight 1.70 Lbs. Open Frame 2.70 Lbs. Chassis and Cover	
Voltage Fluctuations and Flicker	EN 61000-3-3			

MODEL LISTING

Model	Output 1	Output 2	Output 3	Output 4
REL-185-4001	+3.3V/20A ₍₁₎	+5V/10A	+12V/2A	-12V/2A
REL-185-4002	+5V/20A ₍₁₎	+3.3V/10A	+12V/2A	-12V/2A
REL-185-4003	+5V/20A ₍₁₎	+3.3V/10A	+15V/2A	-15V/2A
REL-185-4004	+5V/20A ₍₁₎	-5V/10A	+12V/2A	-12V/2A
REL-185-4005	+5V/20A ₍₁₎	-5V/10A	+15V/2A	-15V/2A
REL-185-4006	+5V/20A ₍₁₎	+24V/3A	+12V/2A	-12V/2A
REL-185-4007	+5V/20A ₍₁₎	+24V/3A	+15V/2A	-15V/2A
REL-185-3001	+5V/20A ₍₁₎	+12V/5A		-12V/3A
REL-185-3002	+5V/20A ₍₁₎	+15V/4A		-15V/3A
REL-185-2001	+3.3V/20A ₍₁₎	+5V/10A		
REL-185-2002	+5V/20A ₍₁₎	+12V/8A		
REL-185-2003	+5V/20A ₍₁₎	+24V/4A		
REL-185-2004	+12V/10A	-12V/6A		
REL-185-2005	+15V/8A	-15V/5A		
REL-185-2006	+15V/6A	+24V/4A		
REL-185-2007	+35V/3.5A	+12V/5.2A		
REL-185-1001	2.5V/37A ₍₂₎			
REL-185-1002	3.3V/37A ₍₂₎			
REL-185-1003	5V/37A ₍₂₎			
REL-185-1004	12V/15.4A			
REL-185-1005	15V/12.3A			
REL-185-1006	24V/7.7A			
REL-185-1007	28V/6.6A			
REL-185-1008	48V/3.8A			
REL-185-1009	6.3V/29A ₍₂₎			

Notes

Consult factory for alternate output configuration.
 Consult factory for positive, negative or floating outputs.
 Refer to Application Information for complete output power ratings.
 All specifications are maximum at 25°C unless otherwise stated and are subjected to change without notice.
 Specify optional chassis and cover or remote when ordering.



SAFETY SPECIFICATIONS

General	Protection Class:	I
	Overvoltage Category:	II
	Pollution Degree:	2

	Underwriters Laboratories File E137708	UL 60950-1 First Edition UL 60601-1 First Edition	
---	--	--	--

	CB Report per IEC 60950-1(2001) Edition Deviations CB Report Per IEC 60601-1(1988) First Edition, A1, A2	First All National
---	--	-----------------------

	UL Recognition Mark for Canada File E137708	CAN/CSA-C22.2 No. 60950-1-03 CAN/CSA-C22.2 No. 601-1-M90	with updates 1 and 2
---	--	---	----------------------

	TUV	EN 60950-1:2001 EN 60601-1/A2: 1995	
	Low Voltage Directive		

REL-185 SERIES MECHANICAL SPECIFICATIONS

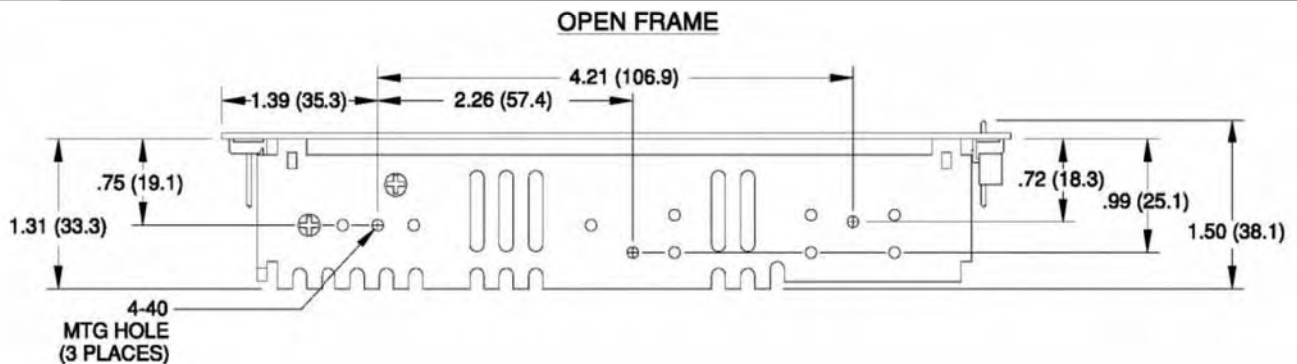

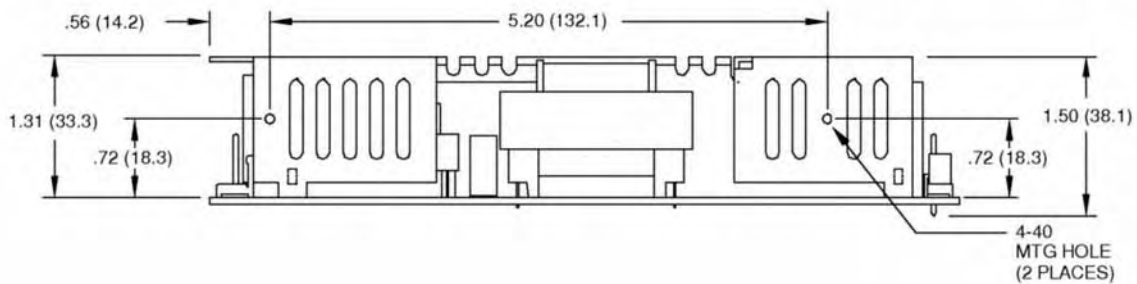
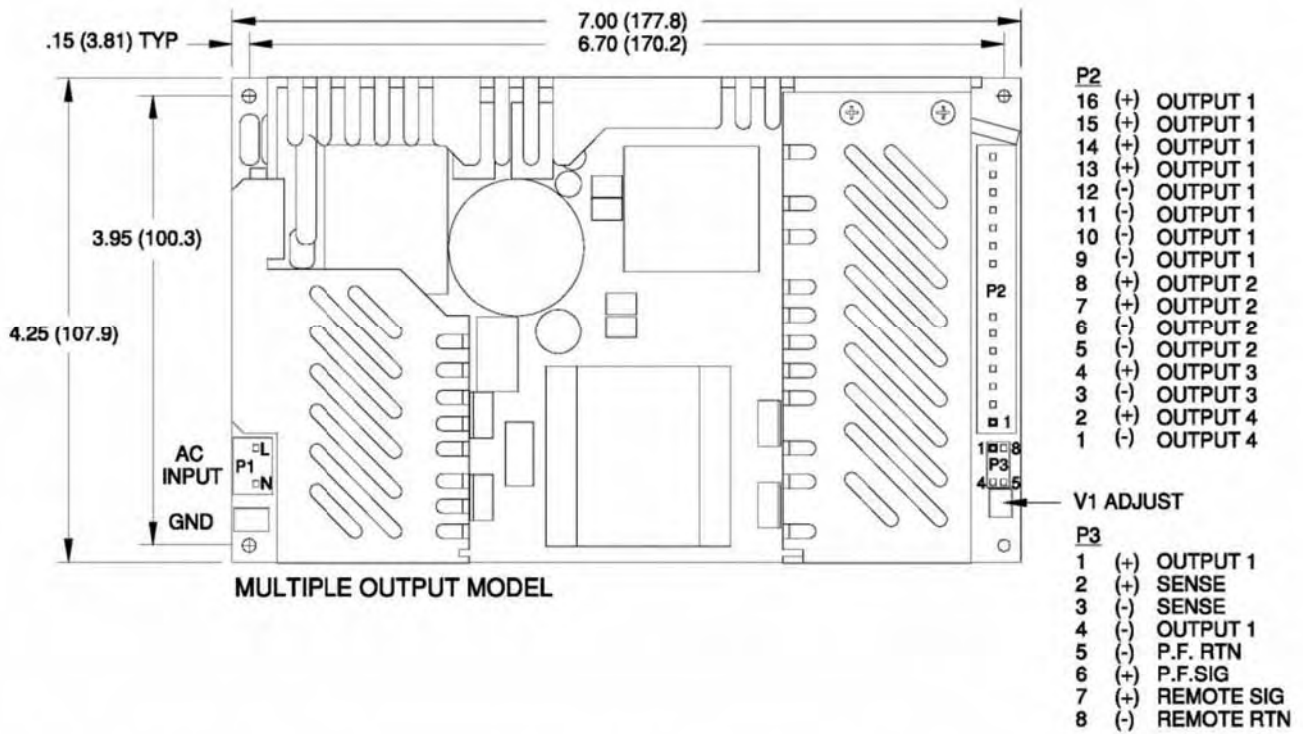
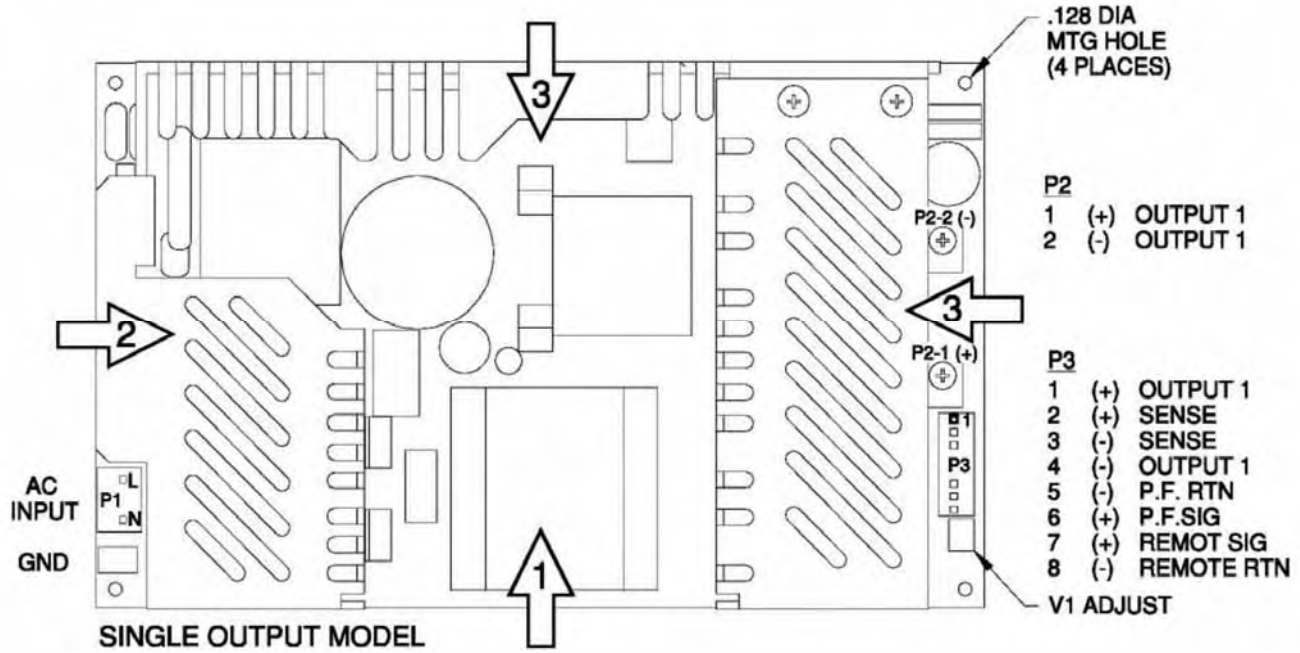

OPTIONAL CHASSIS/COVER

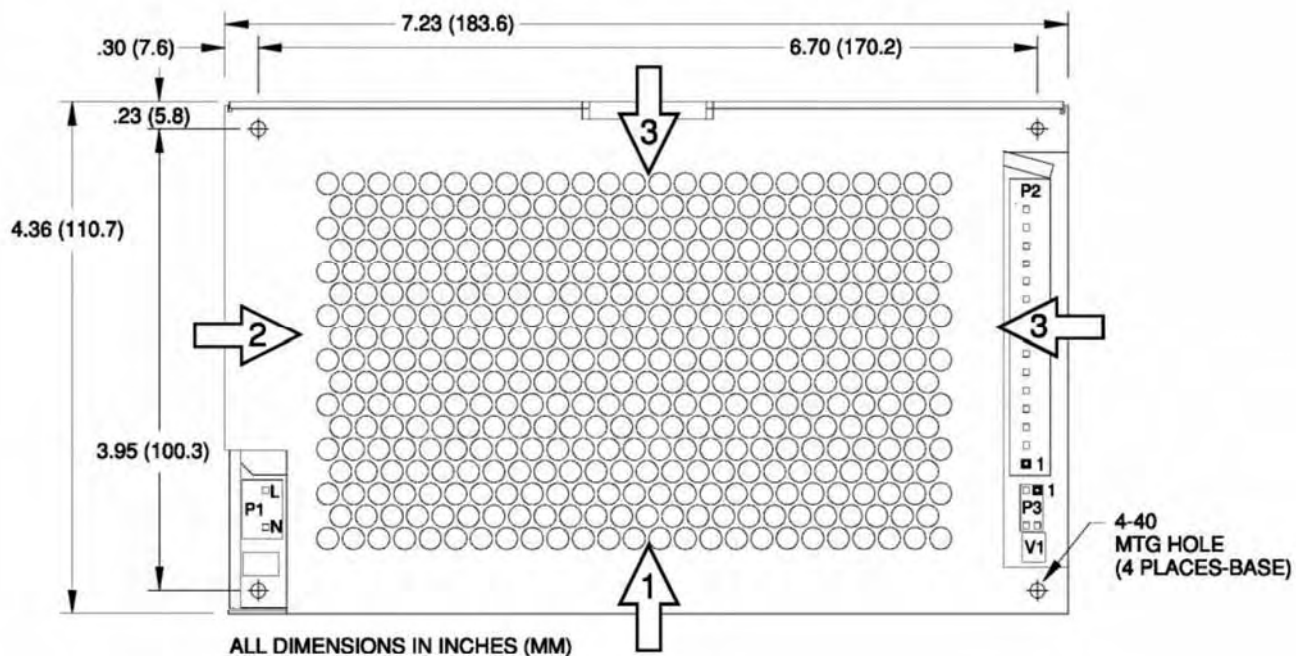
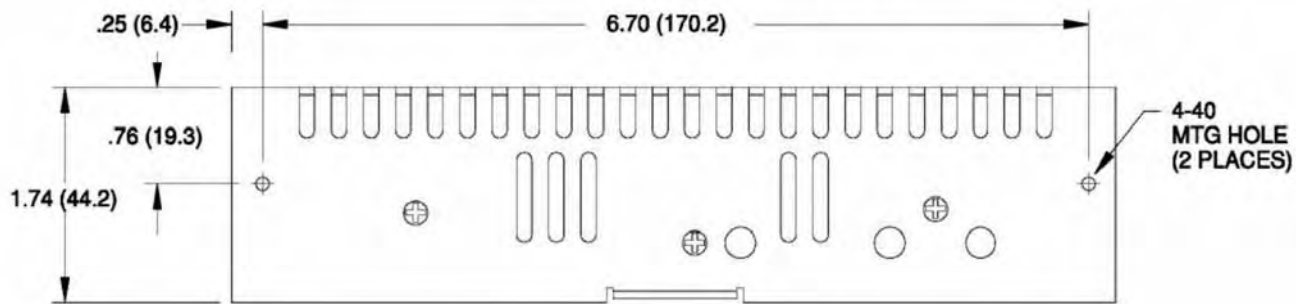

APPLICATIONS INFORMATION

1. Rated 15A with convection cooling.
2. Rated 27A with convection cooling.
3. Total power must not exceed 135 watts with convection cooling on open frame models except where noted.
4. Total power must not exceed 185 watts with 300 LFM forced air cooling on open frame models.
5. Total power must not exceed 110 watts with convection cooling and chassis/cover option.
6. Total power must not exceed 185 watts with 300 LMF forced air cooling and chassis/cover option.
7. Total current from Outputs 3 & 4 must not exceed 3 amps with convection cooling.
8. Total current from Outputs 1 & 2 must not exceed 20 amps with convection cooling.
9. Semiconductor case temperature must not exceed 110° C.
10. Each output can deliver its rated current but total output power must not exceed maximum power as determined by the cooling method state above.
11. Sufficient area must be provided around convection cooled power supplies to allow natural movement of air develop.
12. 300 linear feet per minute of airflow must be maintained one inch above any point of the heatsink in the direction shown when forced air cooling is required.
13. This product is intended for use as a professionally installed component within information technology and medical equipment.
14. A minimum load of 10% is required on output one to insure proper regulation of remaining outputs.
15. Remote sense terminals may be used to compensate for cable losses up to 250mV. The use of a twisted pair is recommended as well as a decoupling capacitor (0.1 0 10 μ F) and a capacitor of 100 μ F/amp connected across the load.
16. Peak to peak output ripple and noise is measured directly at the output terminals of the power supply, without the use of the probe ground lead or retractable tip, 20 MHz bandwidth.
17. This product was type tested and safety certificated using the the dielectric strength test voltages listed in Table V of UL 60601-1. In consideration of clause 20.4g, care must be taken to insure the voltage applied to a reinforced insulation does not over stress basic insulation. Secondary to ground capacitors may need to be removed prior to performing a dielectric strength type test on the end product. It is highly recommended that the DC test voltages listed in DVB.1. Annex DVB are not exceeded during a production-line dielectric strength test of the assembled end product. Please consult factory for further information.
18. This power supply has been safety approved and final tested using a DC dielectric strength test. Please consult factory before performing AC dielectric strength test.
19. Maximum screw penetration into bottom chassis mounting holes is .100 inches.
20. Maximum screw penetration into side chassis mounting holes is .250 inches.
21. To meet emissions specifications, all four mounting hole ground pads must be electrically connected to a common metal chassis. Chassis/cover option recommended.
22. This product is use only one fuse in the input circuit. In consideration of clause 57.6 of UL 60601-1, a second fuse may be required in the end product.

Maximum Output Power vs. Ambient Temperature

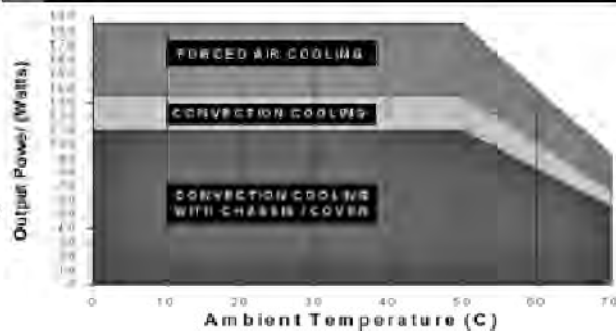

CONNECTOR SPECIFICATIONS

P1 AC Input	.156 friction lock header mates with Molex 09-50-3031 or equivalent crimp terminal housing with Molex 2478 or equivalent crimp terminal.
P2 DC Output (Single)	6-32 screw down terminal mates with #6 ring tongue terminal.(10 in-lb max)
P2 DC Output (Multiple)	.156 friction lock header mates with Molex 09-50-3161 or equivalent crimp terminal housing with Molex 2478 or equivalent crimp terminal.
G Ground	.187 quick disconnect terminal.
P3 Option/Sense (Single)	.100 friction lock header mates with Molex 50-57-9008 or equivalent crimp terminal housing with Molex type 71851 or equivalent crimp terminal.
P3 Option/Sense (Multiple)	.100 breakaway header mates with Molex 22-55-2081 or equivalent crimp terminal housing with Molex type 71851 or equivalent crimp terminal.

RECOMMENDED AIR FLOW DIRECTION

1.Optimum 2.Good 3.Fair