





















3/2-directional valve, electrically operated, Series AS2-SOV

- Compressed air connection G 1/4, G 3/8
- pipe connection
- ATEX optional



Version	Poppet valve, Can be assembled into blocks
Parts	3/2-directional valve, electrically operated
Nominal flow	See table below
Nominal flow 1 ▶ 2	2.03 Cv
Nominal flow 2 ▶ 3	0.386 Cv
Working pressure min./max.	37 ... 145 psi
Medium	Compressed air, Neutral gases
Medium temperature min./max.	14 ... 122 °F
Ambient temperature min./max.	14 ... 122 °F
Sealing principle	Soft sealing
Max. particle size	25 µm
Protection class acc. to DIN EN 61140, with plug	See table below
Weight	0.483 lbs

Technical data

Part No.			Compressed air connection input	Compressed air connection output	Exhaust
R412006264		—	G 1/4	G 1/4	G 1/4
R412006268		—	G 3/8	G 3/8	G 1/4
R412006258		—	G 1/4	G 1/4	G 1/4
R412006259		—	G 3/8	G 3/8	G 1/4
R412006265			G 1/4	G 1/4	G 1/4
R412006266			G 1/4	G 1/4	G 1/4
R412006267			G 1/4	G 1/4	G 1/4
R412006269			G 3/8	G 3/8	G 1/4
R412006270			G 3/8	G 3/8	G 1/4
R412006271			G 3/8	G 3/8	G 1/4
R412006380			G 1/4	G 1/4	G 1/4
R412006381			G 3/8	G 3/8	G 1/4

Part No.	Operationalvoltage	Operationalvoltage	Operationalvoltage	Power consumption
	DC	AC 50 Hz	AC 60 Hz	DC
R412006264	-	-	-	-
R412006268	-	-	-	-
R412006258	-	-	-	-
R412006259	-	-	-	-
R412006265	24 V	-	-	2 W
R412006266	-	110 V	110 V	-
R412006267	-	220 V	230 V	-
R412006269	24 V	-	-	2 W

Part No.	Operationalvoltage	Operationalvoltage	Operationalvoltage	Power consumption
	DC	AC 50 Hz	AC 60 Hz	DC
R412006270	-	110 V	110 V	-
R412006271	-	220 V	230 V	-
R412006380	24 V	-	-	2 W
R412006381	24 V	-	-	2 W

Part No.	Holding power	Holding power	Switch-on power	Switch-on power	Flow
	AC 50 Hz	AC 60 Hz	AC 50 Hz	AC 60 Hz	Qn
R412006264	-	-	-	-	2.03 Cv
R412006268	-	-	-	-	2.03 Cv
R412006258	-	-	-	-	2.03 Cv
R412006259	-	-	-	-	2.03 Cv
R412006265	-	-	-	-	2.03 Cv
R412006266	1.6 VA	1.4 VA	2.2 VA	1.6 VA	2.03 Cv
R412006267	1.6 VA	1.4 VA	2.2 VA	1.6 VA	2.03 Cv
R412006269	-	-	-	-	2.03 Cv
R412006270	1.6 VA	1.4 VA	2.2 VA	1.6 VA	2.03 Cv
R412006271	1.6 VA	1.4 VA	2.2 VA	1.6 VA	2.03 Cv
R412006380	-	-	-	-	2.03 Cv
R412006381	-	-	-	-	-

Part No.	Protection class	Electrical connection	Connector standard
		Pilot valve	
R412006264	-	-	-
R412006268	-	-	-
R412006258	-	-	-
R412006259	-	-	-
R412006265	IP65	Plug, ISO 15217, form C	ISO 15217
R412006266	IP65	Plug, ISO 15217, form C	ISO 15217
R412006267	IP65	Plug, ISO 15217, form C	ISO 15217
R412006269	IP65	Plug, ISO 15217, form C	ISO 15217
R412006270	IP65	Plug, ISO 15217, form C	ISO 15217
R412006271	IP65	Plug, ISO 15217, form C	ISO 15217
R412006380	IP65	Plug, M12x1	-
R412006381	IP65	Plug, M12x1	-

Part No.	basic valve with electrical connector
R412006264	Basic valve without pilot valve
R412006268	Basic valve without pilot valve
R412006258	Basic valve without pilot valve, with CNOMO subbase
R412006259	Basic valve without pilot valve, with CNOMO subbase
R412006265	Basic valve with pilot valve
R412006266	Basic valve with pilot valve
R412006267	Basic valve with pilot valve
R412006269	Basic valve with pilot valve
R412006270	Basic valve with pilot valve
R412006271	Basic valve with pilot valve
R412006380	Basic valve with pilot valve
R412006381	Basic valve with pilot valve

Nominal flow Qn with secondary pressure p2 = 87 psi at Δp = 14.5 psi

1) Suitable for use in Ex zones 1, 2, 21, 22

Technical information

The pressure dew point must be at least 27 °F under ambient and medium temperature and may not exceed 5.4 °F .

ATEX optional: The ATEX ID depends on the selected pilot valve.

A short silencer is required for wall mounting (see accessories e.g. R412004817).

Technical information

Material

Housing	Polyamide
Front plate	Acrylonitrile butadiene styrene
Seals	Acrylonitrile butadiene rubber
Threaded bushing	Die cast zinc

Dimensions

Fig. 1: 3/2-directional valve without pilot valve with porting configuration for series D016

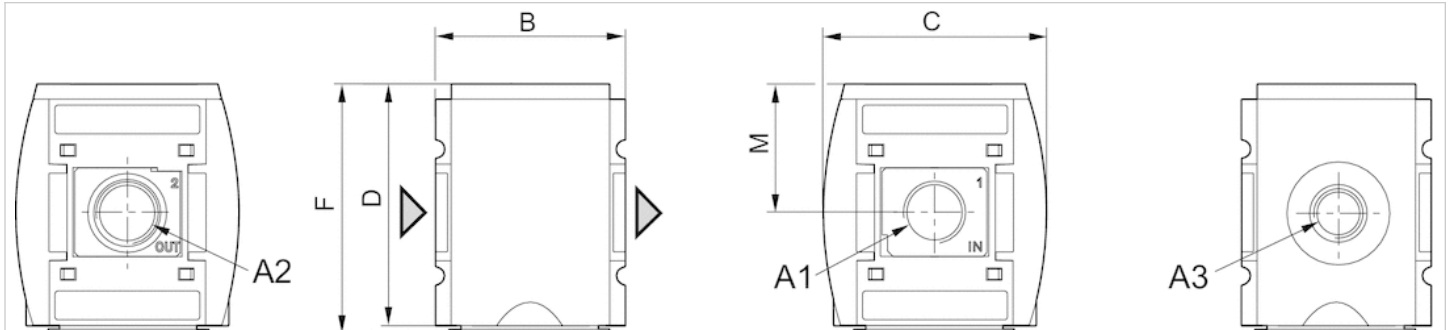

A1 = input A2 = output A3 = ventilation port

Dimensions in mm

A1	A2	A3	B	C	D	F	M
G 1/4	G 1/4	G 1/4	52	59	65	67	34
G 3/8	G 3/8	G 1/4	52	59	65	67	34

Dimensions

Fig. 2: 3/2 directional valve with transition plate (suitable for ATEX)

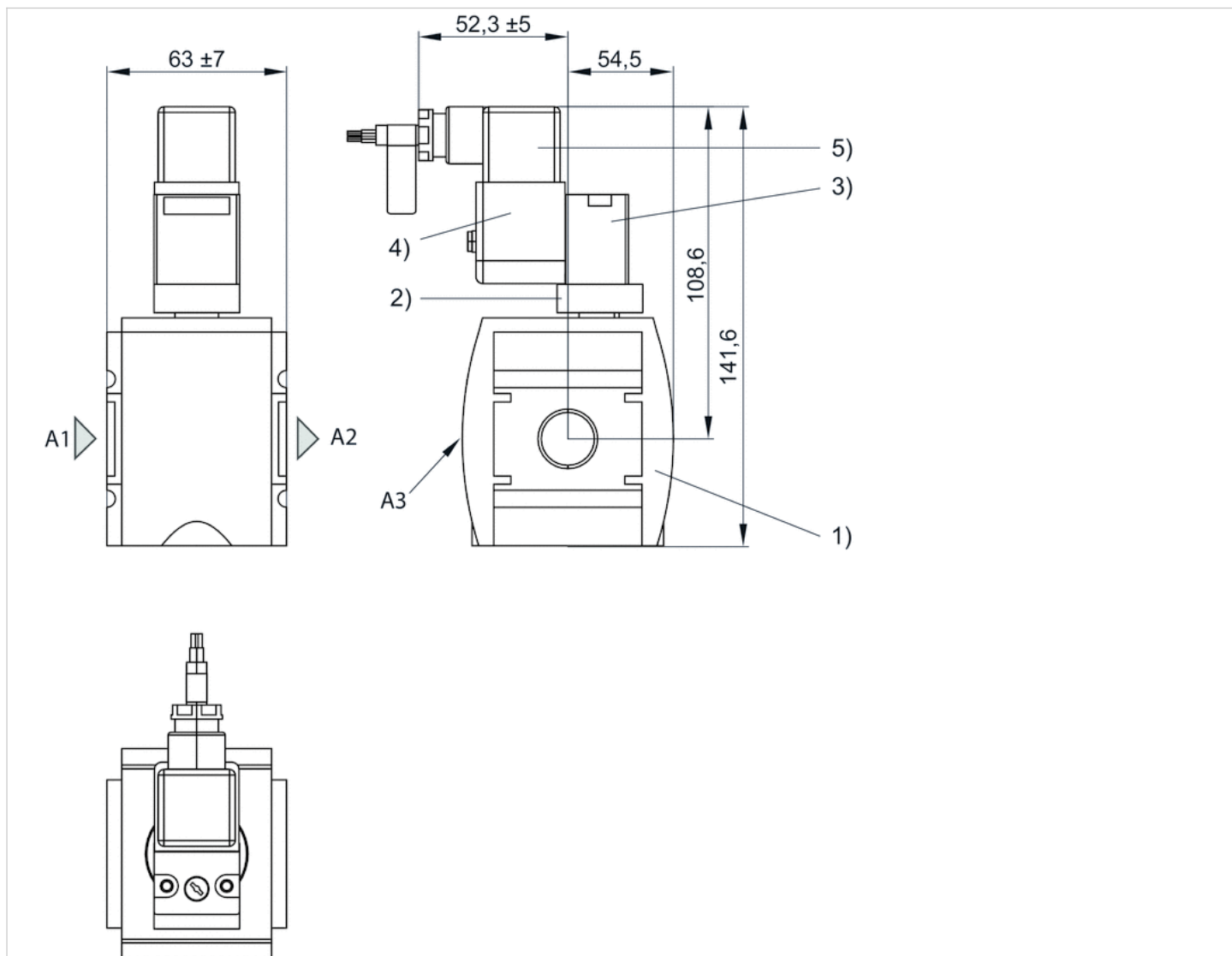

A1 = input A2 = output A3 = ventilation port

1) Shut-off valve 2) Transition plate 3) Pilot valve 4) Coil 5) Electrical connector

See accessories for pilot valve and coil

3/2-directional valve with pilot valve and port for electrical connector form C

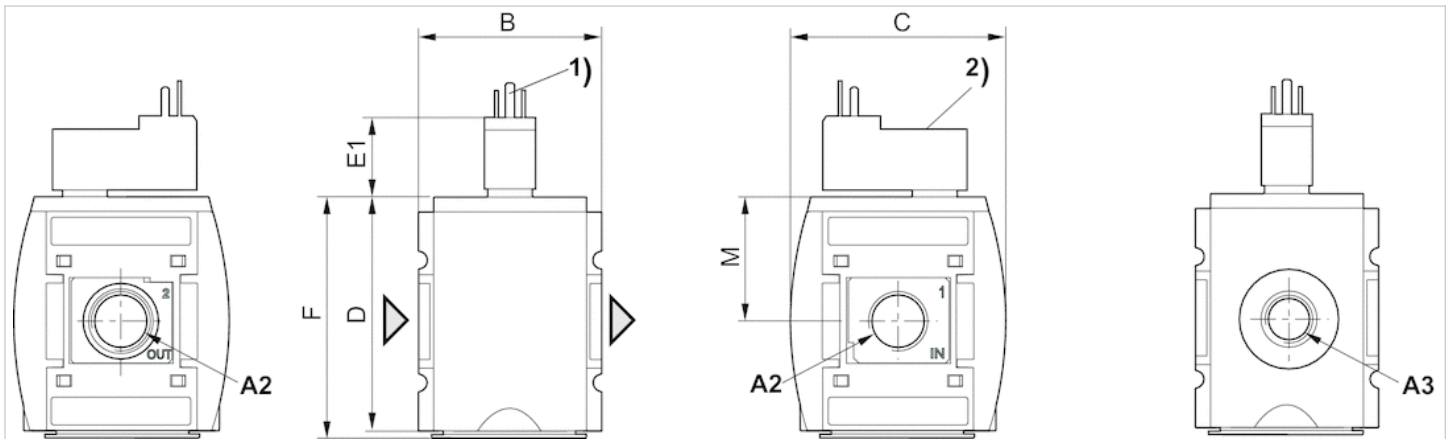

A1 = input A2 = output A3 = ventilation port
 1) For valve plug connectors according to ISO 15217 (form C)
 2) Manual override

Dimensions in mm

A1	G 1/4	A3	B	C	D	F	M
G 1/4	G 1/4	G 1/4	52	59	65	67	34
G 3/8	G 3/8	G 1/4	52	59	65	67	34

Dimensions

Fig. 4: 3/2-directional valve with pilot valve push-in fitting M12x1

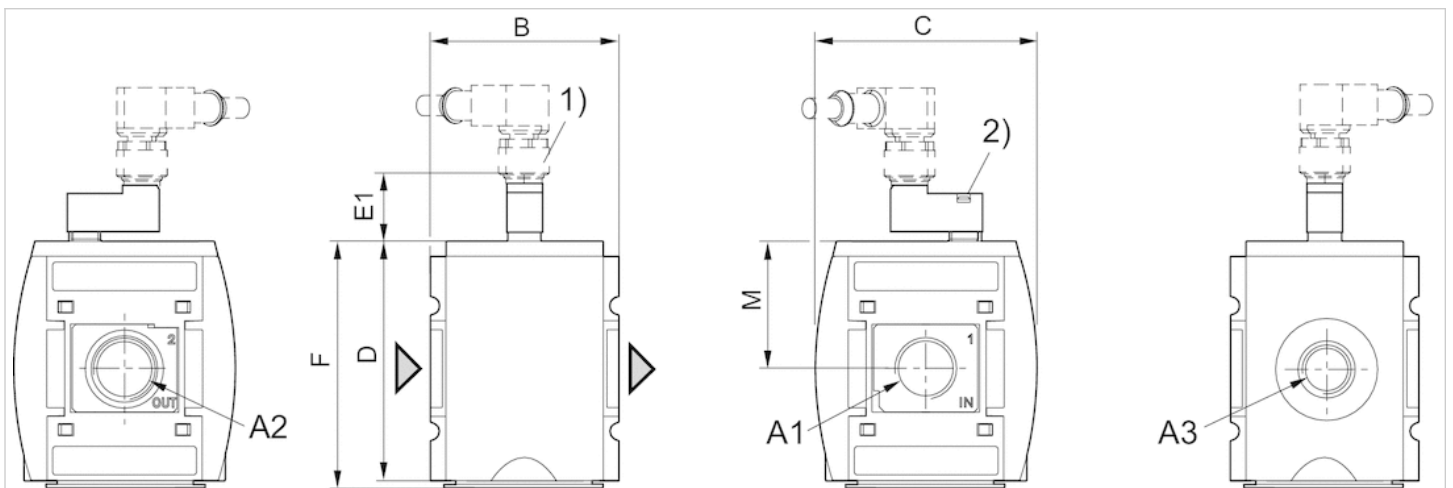

A1 = input A2 = output A3 = ventilation port
 1) plug M12
 2) Manual override

Dimensions in mm

A1	A2	A3	B	C	D	E1	F	M
G 1/4	G 1/4	G 1/4	52	59	65	39	67	34
G 3/8	G 3/8	G 1/4	52	59	65	39	67	34

Diagrams

Rear exhaust

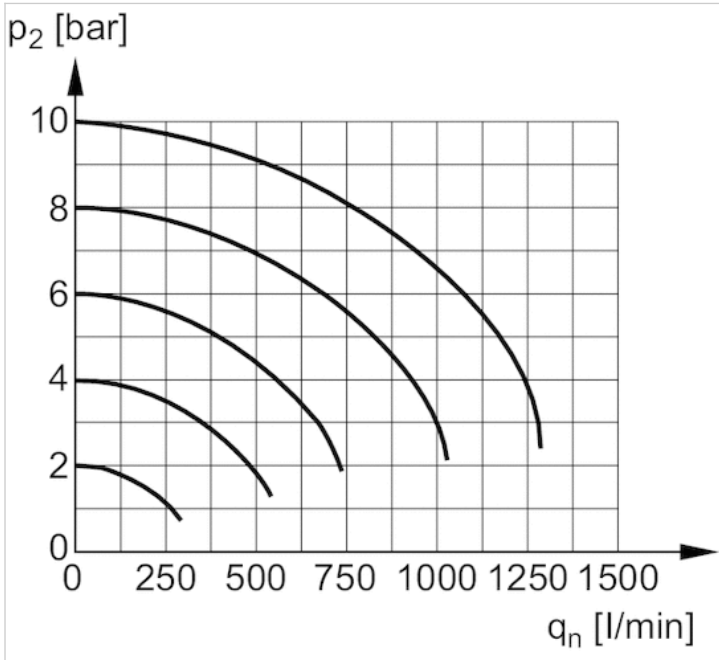

p₂ = secondary pressure
q_n = nominal flow

Flow rate characteristic

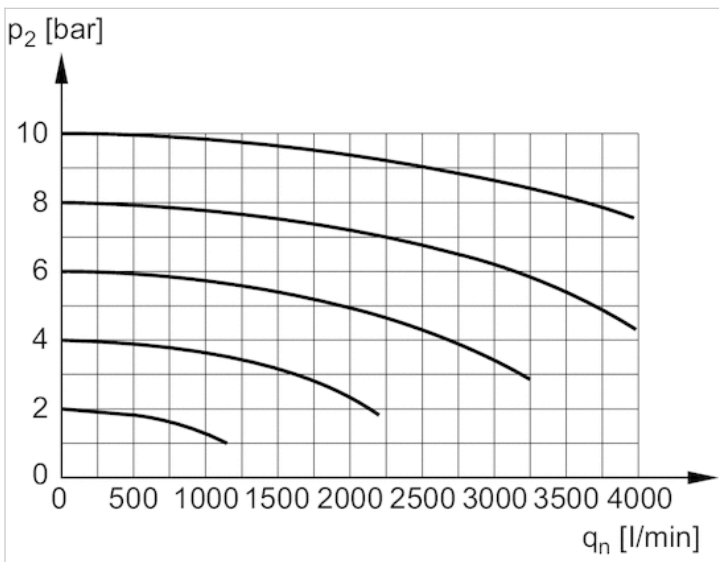

p₂ = secondary pressure
q_n = nominal flow

Pin assignments

Pin assignment M12x1

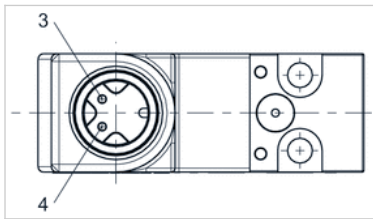

3: +/-

4: +/-