



Preliminary

QPA2962

2 – 20 GHz 10 Watt GaN Amplifier

Product Overview

Qorvo's QPA2962 is a wideband power amplifier fabricated on Qorvo's QGaN15 GaN on SiC process. The QPA2962 operates from 2 to 20 GHz, providing 10 W of saturated power with 13 dB large signal gain and 22 % power-added efficiency at 22 V drain bias. RF ports are matched to 50 Ω , including integrated DC blocking capacitors and a RF choke.

Packaged in a 5 x 5 mm air cavity laminate package, QPA2962 provides designers with a convenient SMT compatible device that delivers a valuable combination of wideband power, gain and efficiency while reducing size and cost. QPA2962 is ideally suited for wideband communications systems, electronic warfare, test instrumentation and radar applications across both military and commercial markets.

QPA2962 is 100% DC and RF tested on-wafer to ensure compliance to electrical specifications.

Lead free and RoHS compliant.

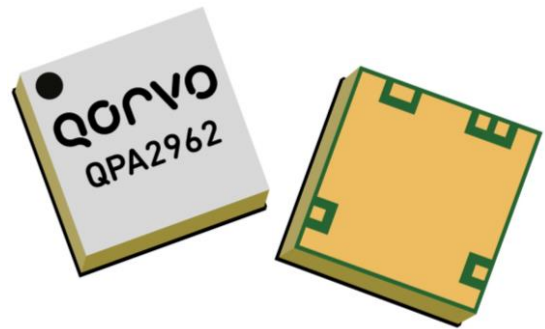

Key Features

- Frequency Range: 2 – 20 GHz
- P_{SAT} ($P_{IN}=27$ dBm): 40 dBm
- PAE ($P_{IN}=27$ dBm): 22 %
- Power Gain ($P_{IN}=27$ dBm): 13 dBm
- Small Signal Gain: 19 dB
- Bias: $V_D = 22$ V, $I_{DQ} = 1680$ mA
- Package Dimensions: 5.0 x 5.0 x 1.455 mm

Performance is typical across frequency. Please reference electrical specification table and data plots for more details.

Functional Block Diagram

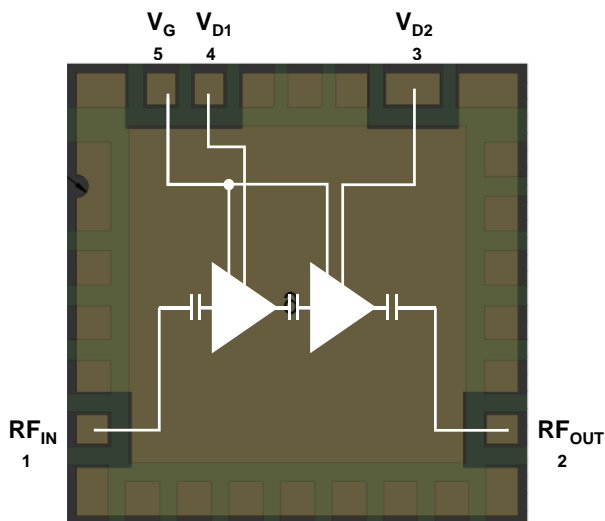

Applications

- Communication Systems
- Electronic Warfare
- Radar
- Test Equipment

Ordering Information

Part No.	Description
QPA2962	2 - 20 GHz 10 Watt GaN Amplifier
QPA2962TR7	250 pieces on a 7" reel (standard)
QPA2962EVB	Evaluation Board for QPA2962

Absolute Maximum Ratings

Parameter	Value / Range
Drain Voltage (V_D)	29.5 V
Gate Voltage Range (V_G)	-4 to 0 V
Drain Current (I_D)	2848 mA
Gate Current (I_G)	10 mA
Power Dissipation (P_{DISS}), $T_{BASE} = 85^\circ\text{C}$	40 W
Input Power (P_{IN}), 50 Ω , $V_D = 22$ V, $I_{DQ} = 1680$ mA, $T_{BASE} = 85^\circ\text{C}$	33 dBm
Input Power (P_{IN}), 3:1 VSWR, $V_D = 22$ V, $I_{DQ} = 1680$ mA, $T_{BASE} = 85^\circ\text{C}$	32 dBm
Mounting Temperature (30 seconds max)	260 $^\circ\text{C}$
Storage Temperature	-55 to 150 $^\circ\text{C}$

Operation of this device outside the parameter ranges given above may cause permanent damage. These are stress ratings only, and functional operation of the device at these conditions is not implied.

Recommended Operating Conditions

Parameter	Min	Typ	Max	Units
Drain Voltage (V_D)		22		V
Drain Current, Quiescent (I_{DQ})		1680		mA
Drain Current, RF (I_{D_Drive})	See charts page 6, 7, 10, 13, 16			mA
Gate Voltage Typ. Range (V_G)	-1.2 to -2.5			V
Gate Current, RF (I_{G_Drive})	See charts page 6 - 7			mA
Operating Temp. Range, T_{BASE}	-40	+25	+85	$^\circ\text{C}$

Electrical specifications are measured at specified test conditions. Specifications are not guaranteed over all recommended operating conditions.

Electrical Specifications

Parameter	Conditions ⁽¹⁾ ⁽²⁾	Min	Typ	Max	Units
Operational Frequency Range		2		20	GHz
Output Power at Saturation, P_{SAT}	$P_{IN} = +27$ dBm, Frequency = 2 - 18 GHz		40		dBm
	$P_{IN} = +27$ dBm, Frequency = 19 - 20 GHz		39		
Power Added Efficiency, PAE	$P_{IN} = +27$ dBm, Frequency = 2 - 18 GHz		22		%
	$P_{IN} = +27$ dBm, Frequency = 19 - 20 GHz		15		
Small Signal Gain, S_{21}			19		dB
Input Return Loss, IRL			10		dB
Output Return Loss, ORL			7		dB
P_{SAT} Temperature Coefficient	$T_{DIFF} = -40^\circ\text{C}$ to $+85^\circ\text{C}$; $P_{IN} = +27$ dBm		-0.009		dBm/ $^\circ\text{C}$
S_{21} Temperature Coefficient	$T_{DIFF} = -40^\circ\text{C}$ to $+85^\circ\text{C}$		-0.04		dB/ $^\circ\text{C}$

Notes:

1. Test conditions unless otherwise noted: CW, $V_D = 22$ V, $I_{DQ} = 1680$ mA, adjusting V_G , $T_{BASE} = +25^\circ\text{C}$, $Z_0 = 50 \Omega$
2. T_{BASE} is back side of package

Performance Plots – Small Signal

Test conditions unless otherwise noted: CW, $V_D = 22\text{ V}$, $I_{DQ} = 1680\text{ mA}$, $T_{BASE} = +25\text{ }^\circ\text{C}$

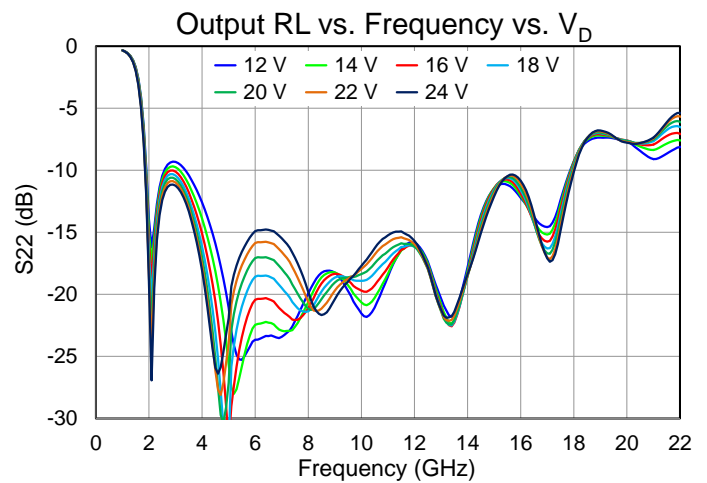
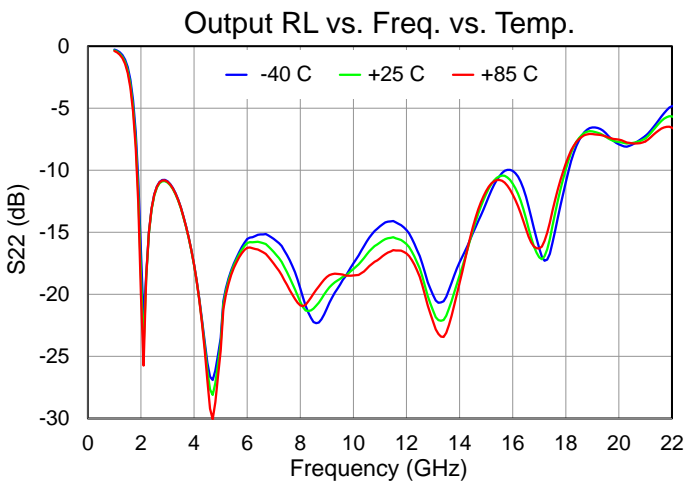
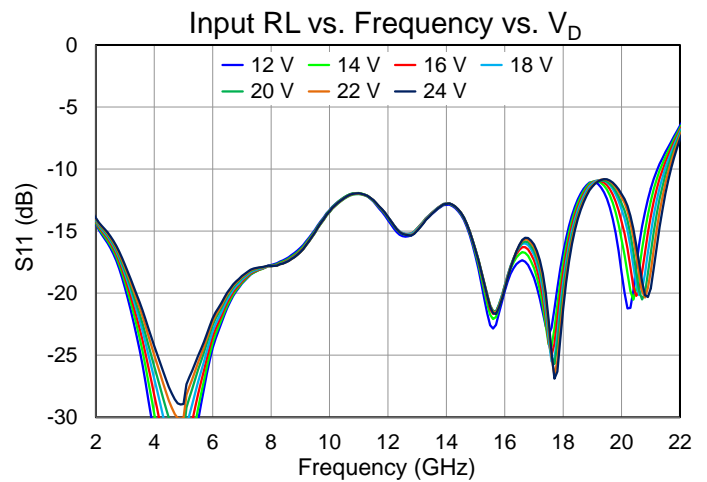
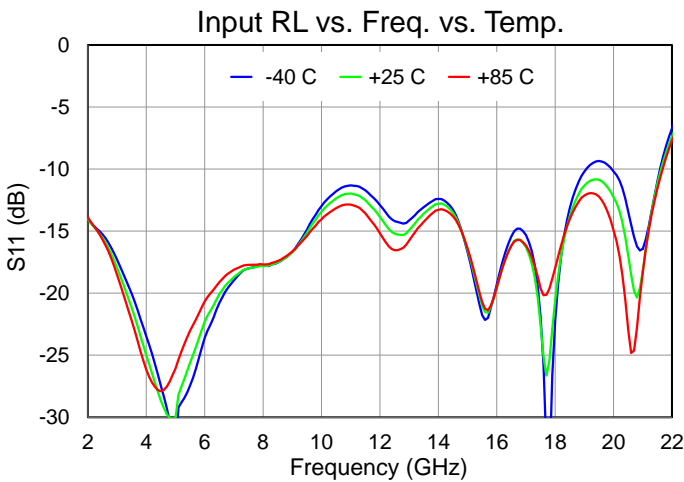
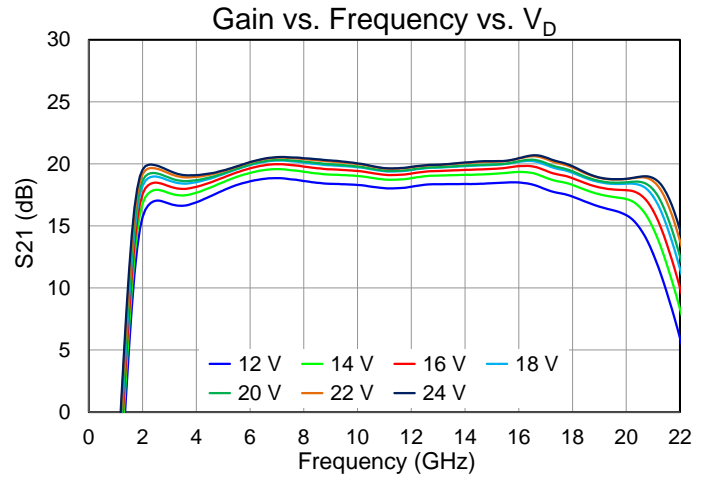
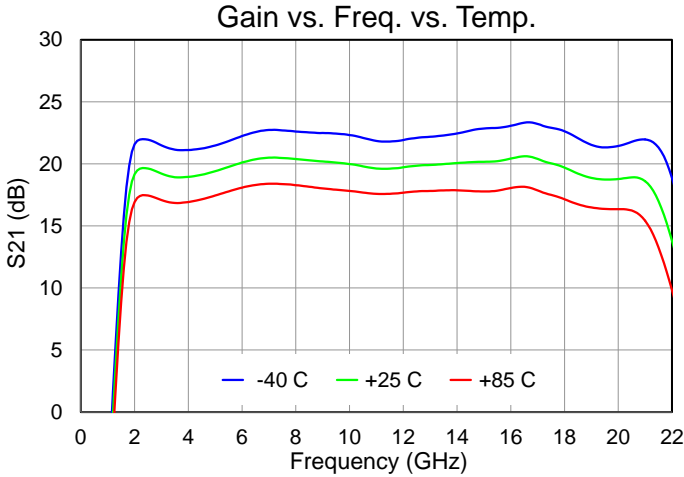

Performance Plots – Small Signal

Test conditions unless otherwise noted: CW, $V_D = 22\text{ V}$, $I_{DQ} = 1680\text{ mA}$, $T_{BASE} = +25\text{ }^\circ\text{C}$

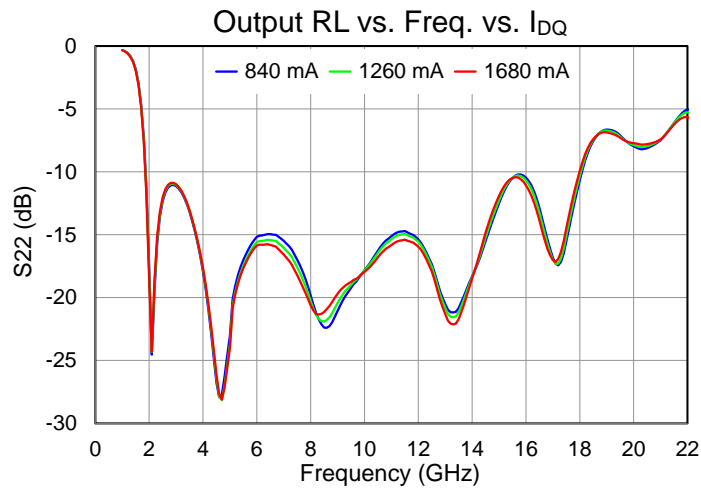
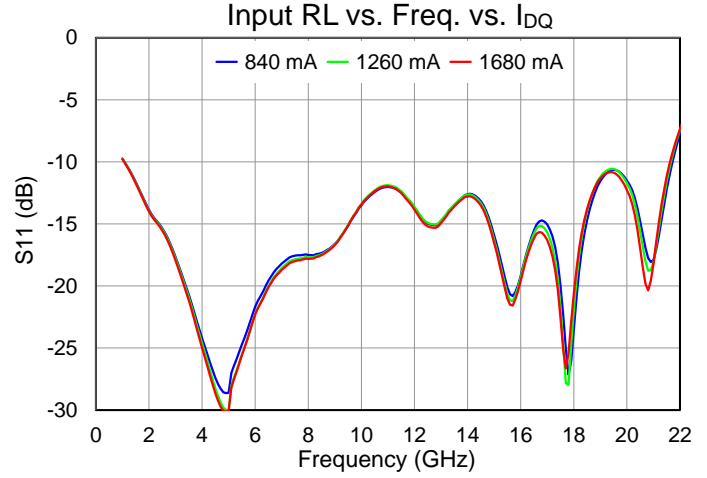
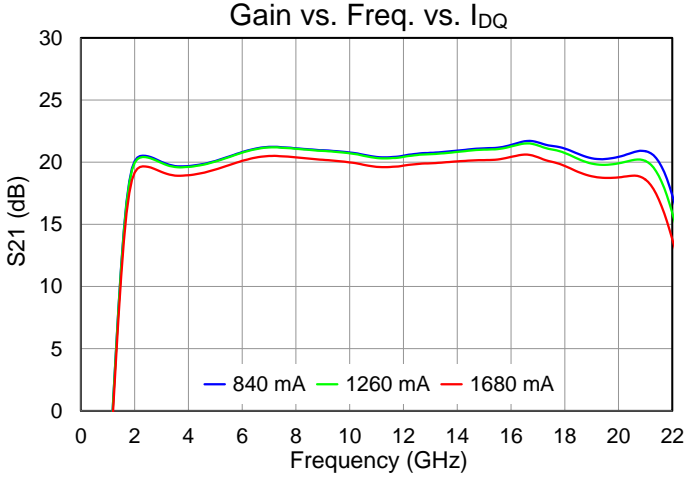

Performance Plots – Large Signal

Test conditions unless otherwise noted: CW, $V_D = 22\text{ V}$, $I_{DQ} = 1680\text{ mA}$, $P_{IN} = 27\text{ dBm}$, $T_{BASE} = +25\text{ }^\circ\text{C}$

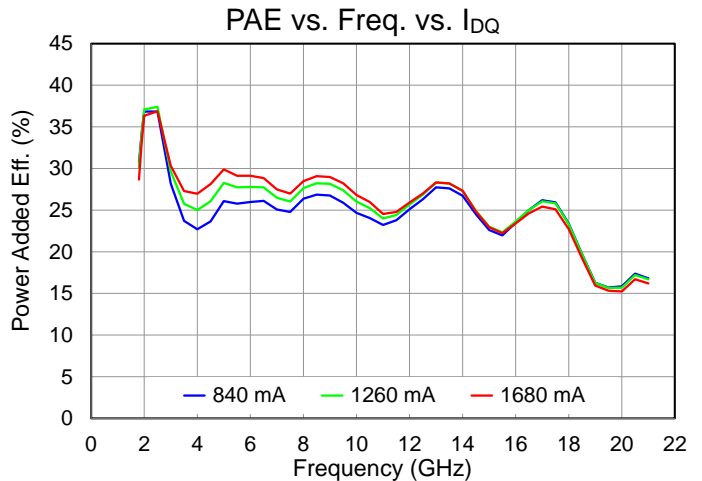
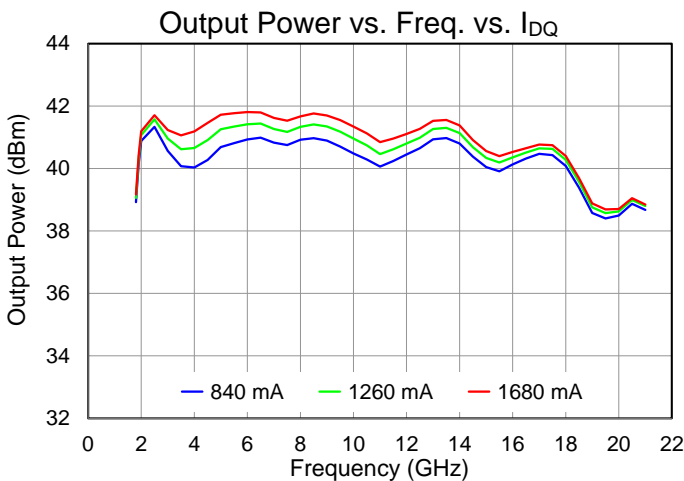
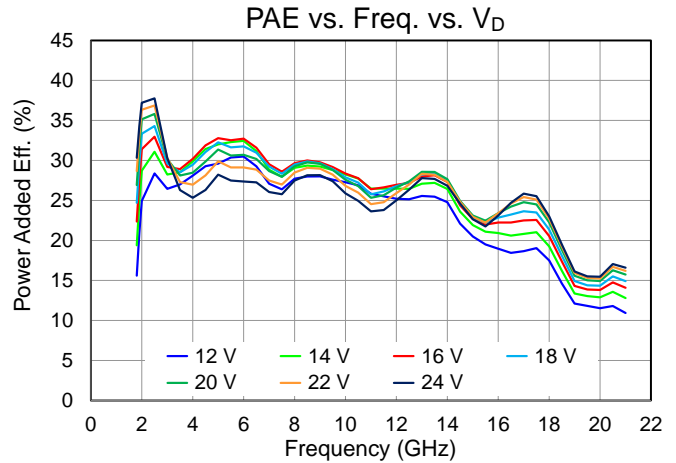
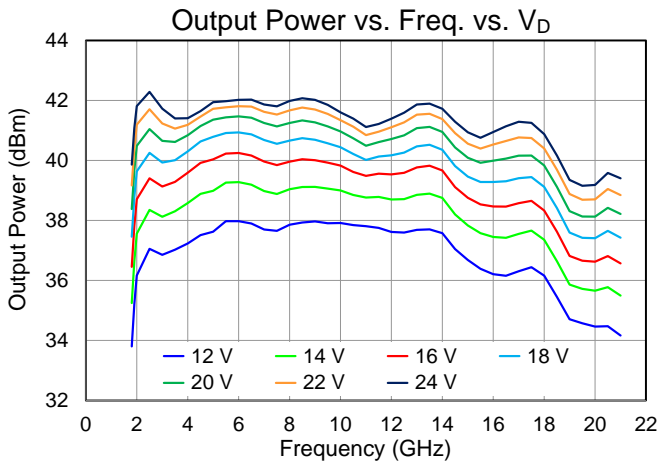
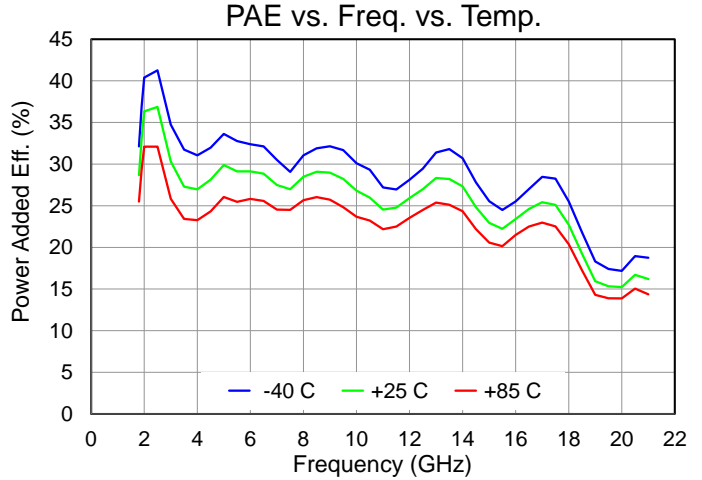
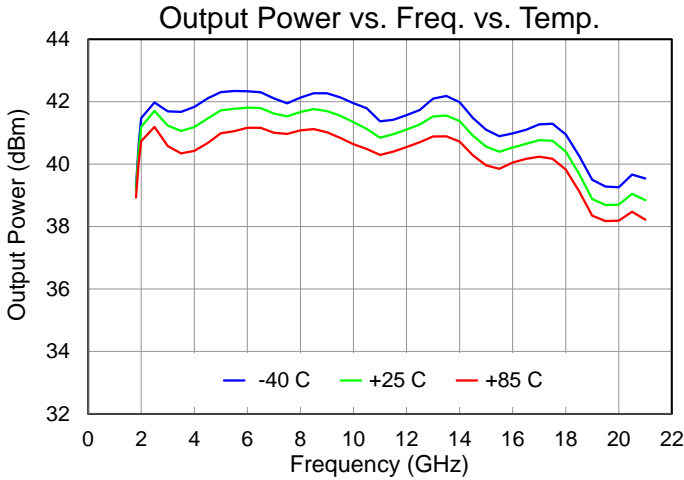

Performance Plots – Large Signal

Test conditions unless otherwise noted: CW, $V_D = 22\text{ V}$, $I_{DQ} = 1680\text{ mA}$, $P_{IN} = 27\text{ dBm}$, $T_{BASE} = +25\text{ }^\circ\text{C}$

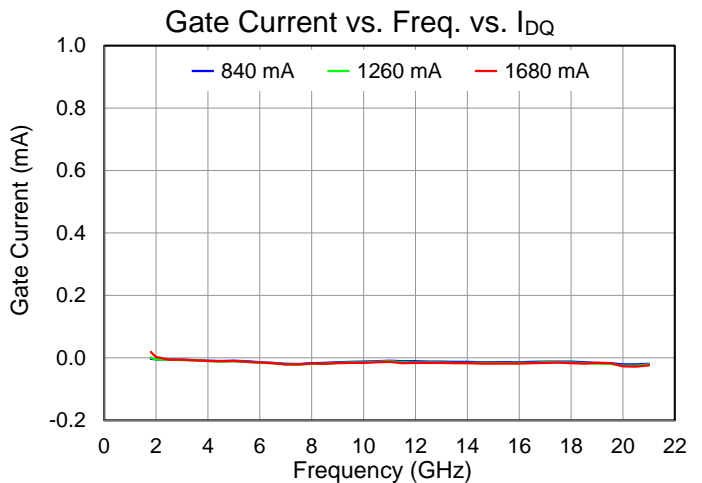
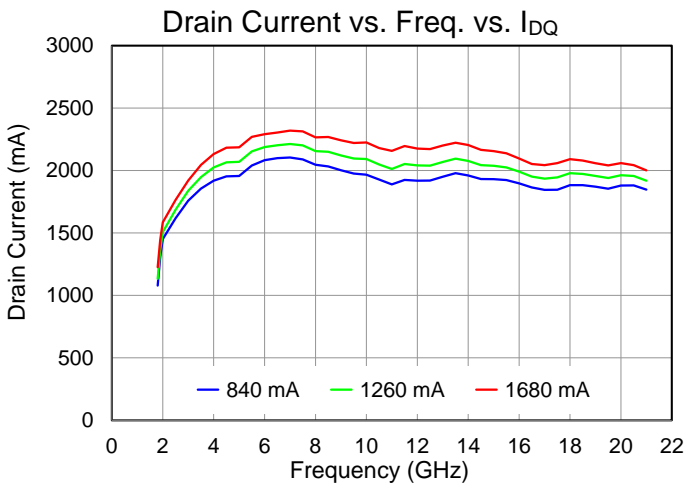
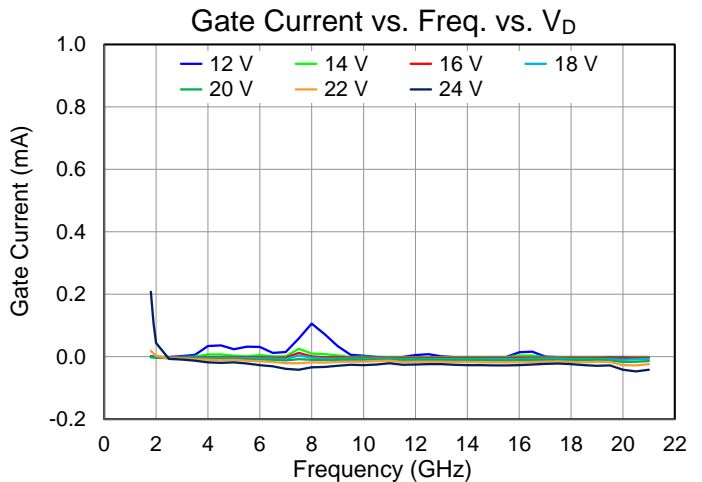
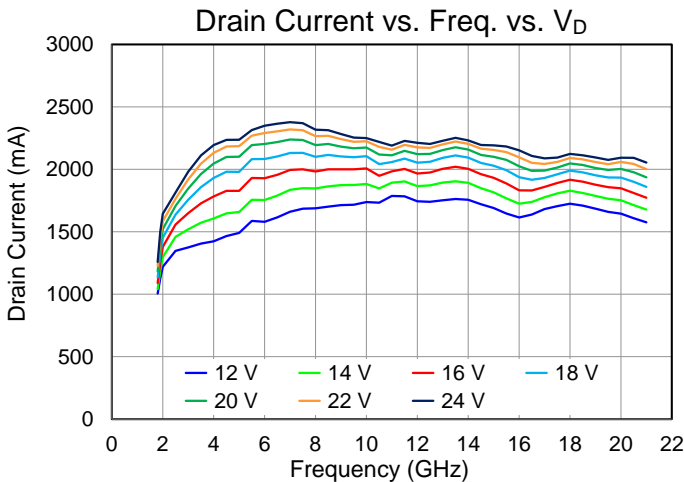
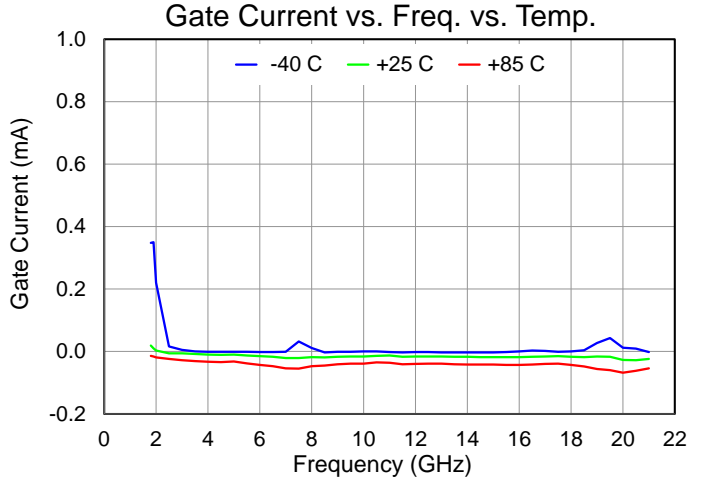
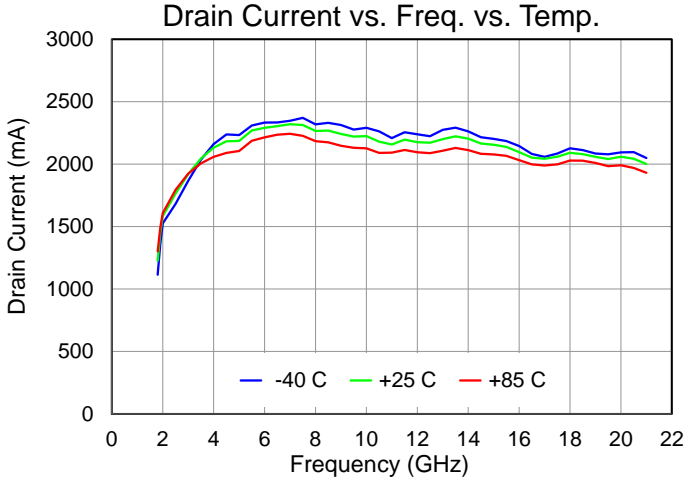

Performance Plots – Large Signal

Test conditions unless otherwise noted: CW, $V_D = 22\text{ V}$, $I_{DQ} = 1680\text{ mA}$, $P_{IN} = 27\text{ dBm}$, $T_{BASE} = +25\text{ }^\circ\text{C}$

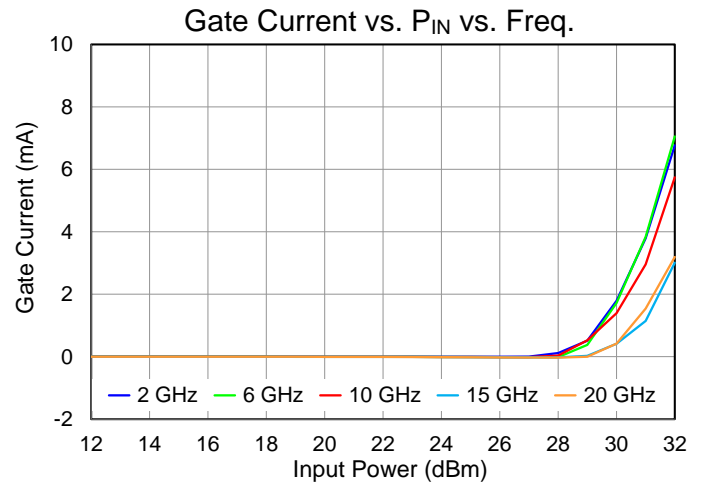
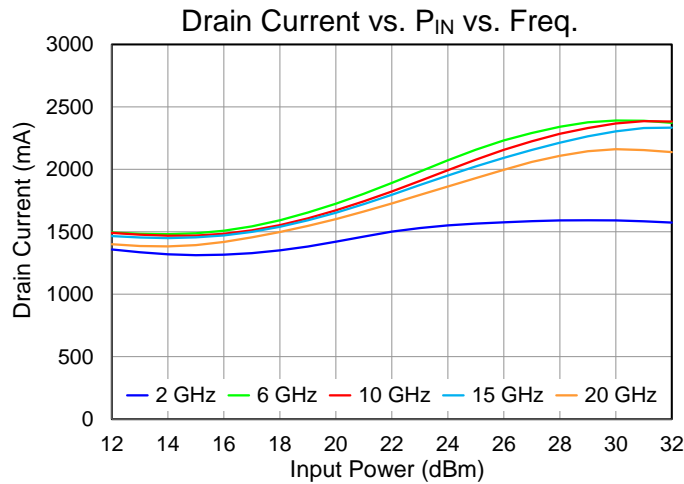
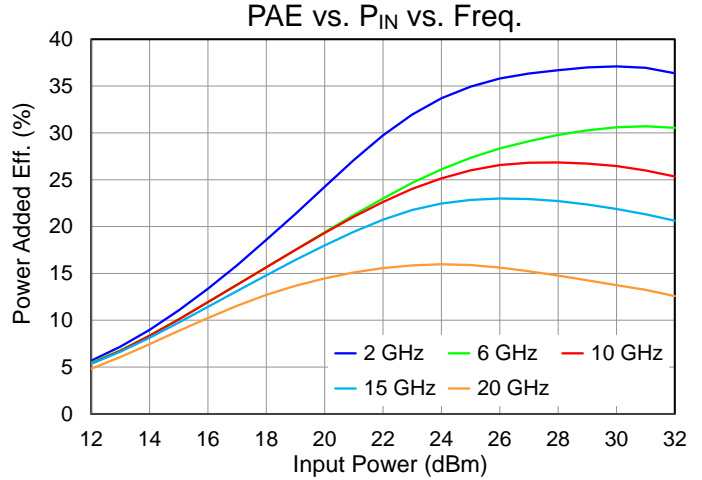
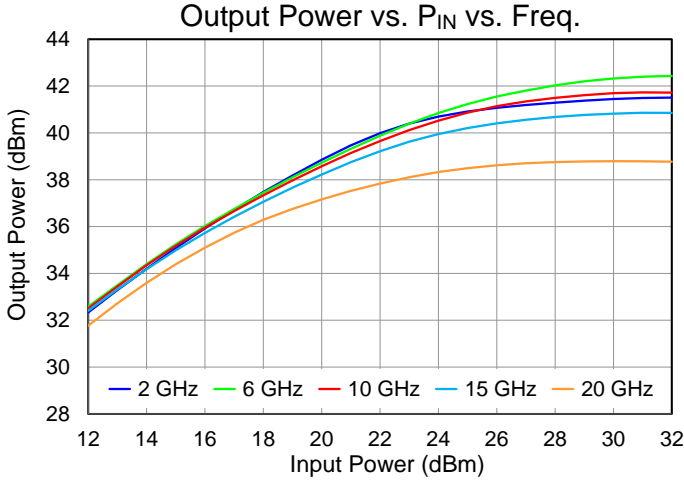

Performance Plots – Large Signal

Test conditions unless otherwise noted: CW, $V_D = 22\text{ V}$, $I_{DQ} = 1680\text{ mA}$, $P_{IN} = 27\text{ dBm}$, $T_{BASE} = +25\text{ }^\circ\text{C}$

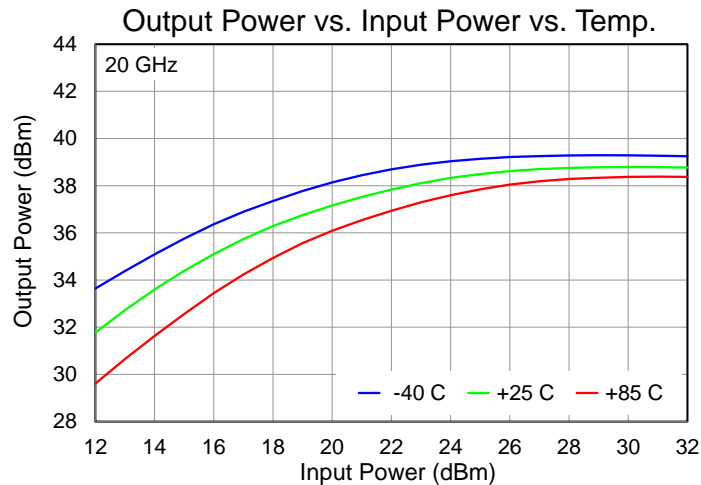
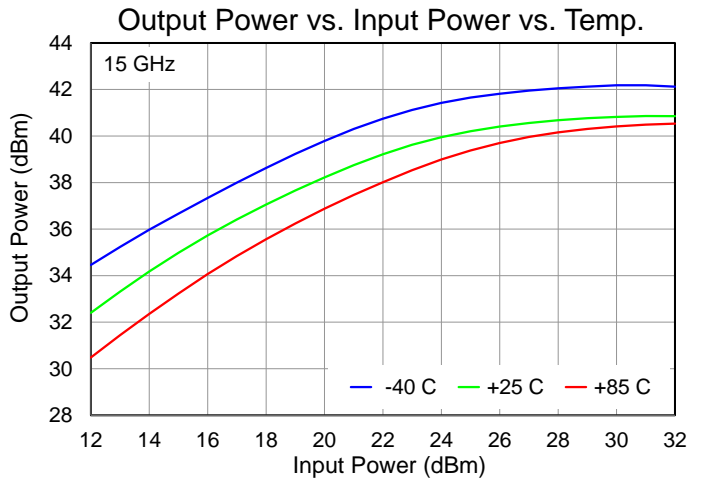
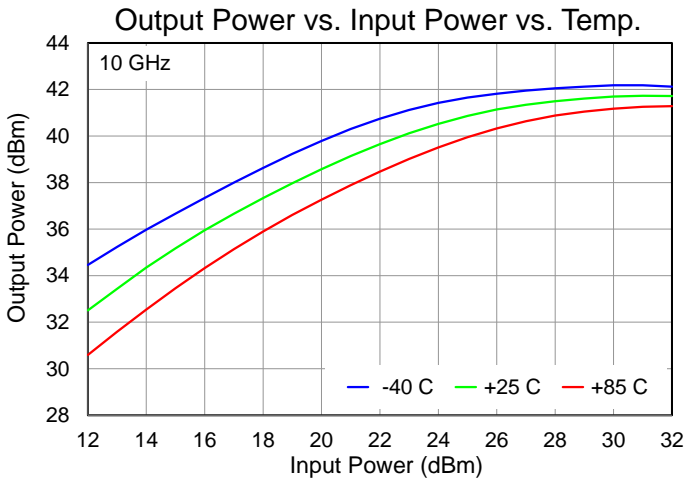
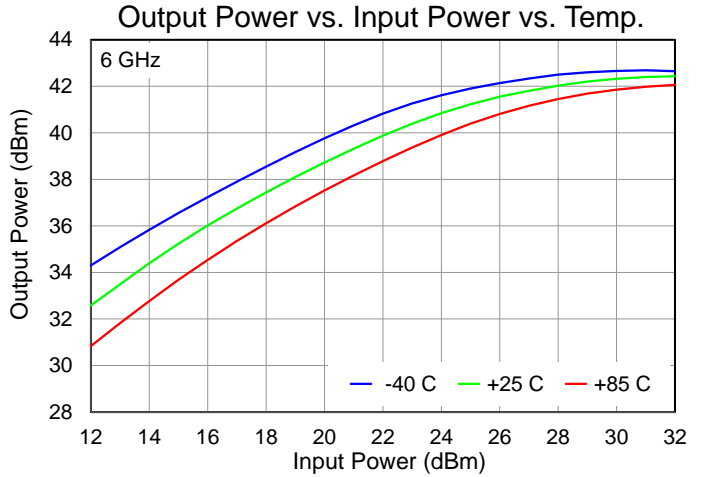
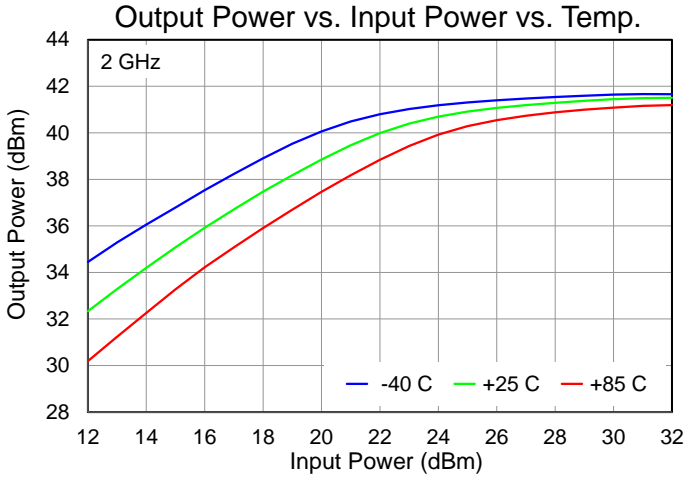

Performance Plots – Large Signal

Test conditions unless otherwise noted: CW, $V_D = 22\text{ V}$, $I_{DQ} = 1680\text{ mA}$, $P_{IN} = 27\text{ dBm}$, $T_{BASE} = +25\text{ }^\circ\text{C}$

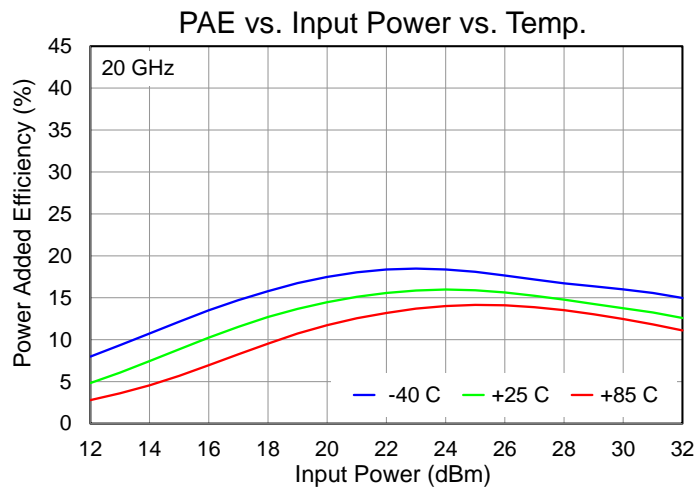
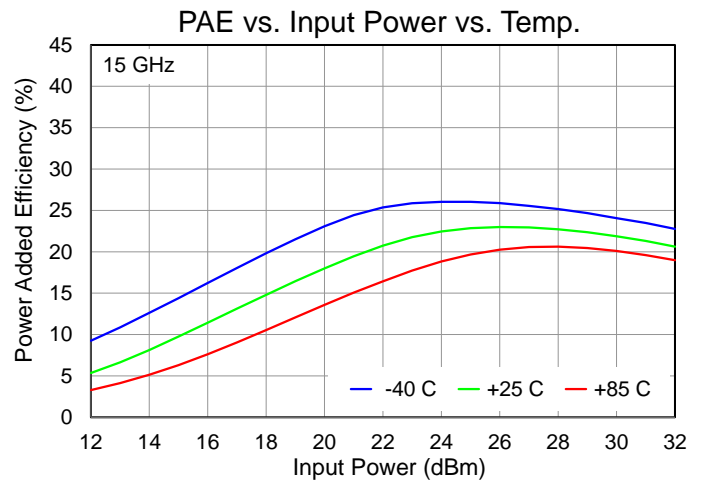
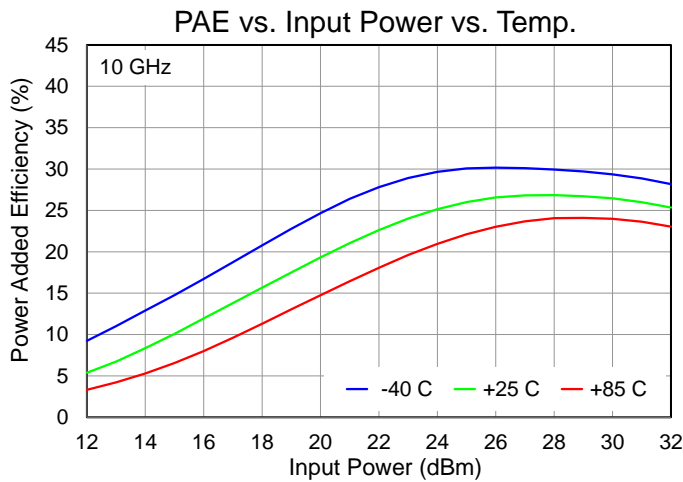
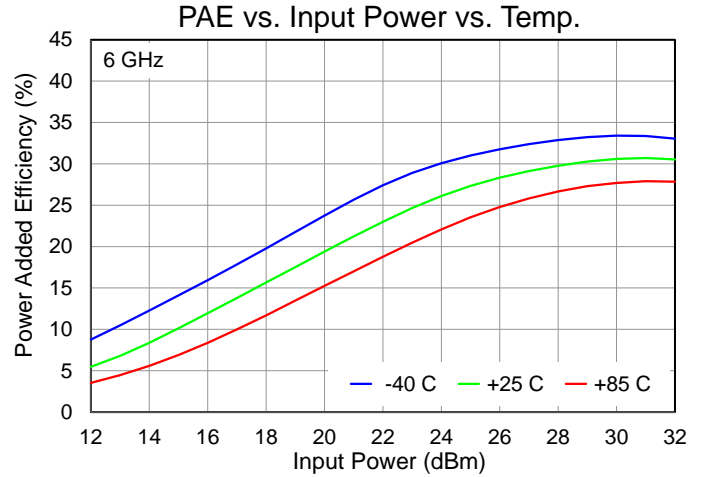
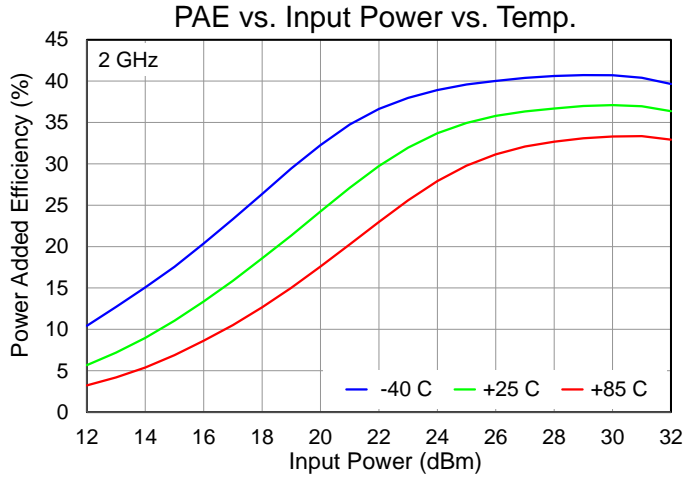

Performance Plots – Large Signal

Test conditions unless otherwise noted: CW, $V_D = 22\text{ V}$, $I_{DQ} = 1680\text{ mA}$, $P_{IN} = 27\text{ dBm}$, $T_{BASE} = +25\text{ }^\circ\text{C}$

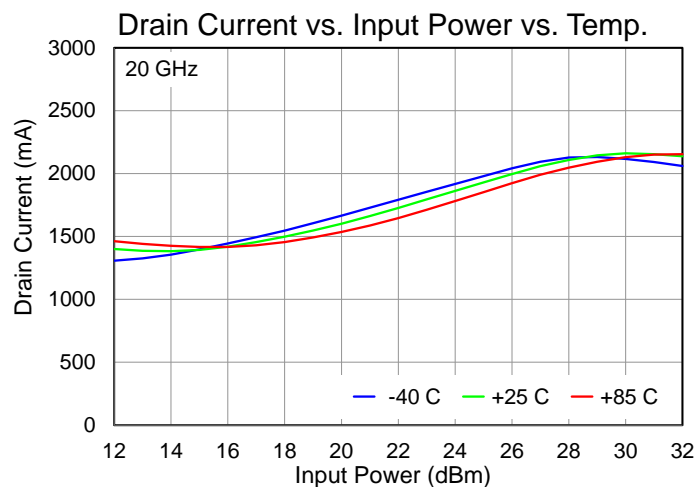
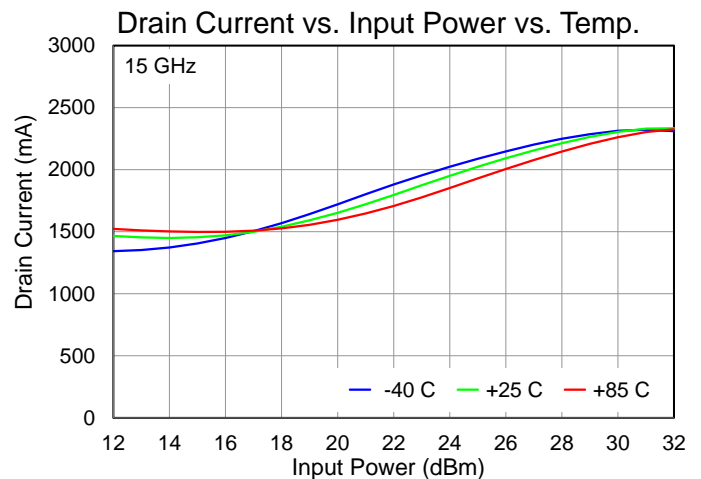
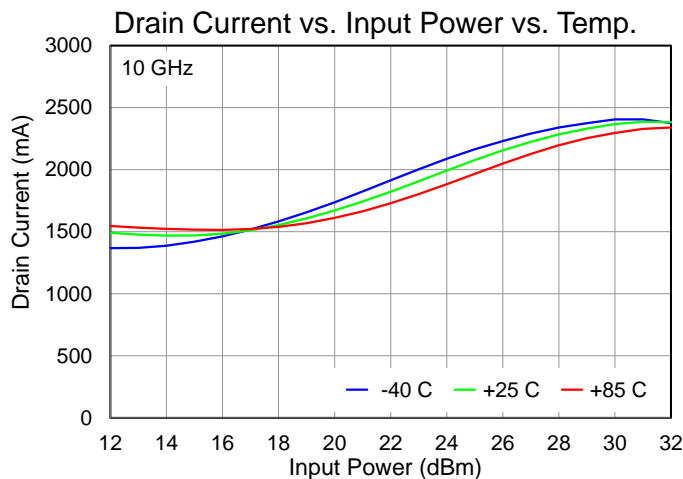
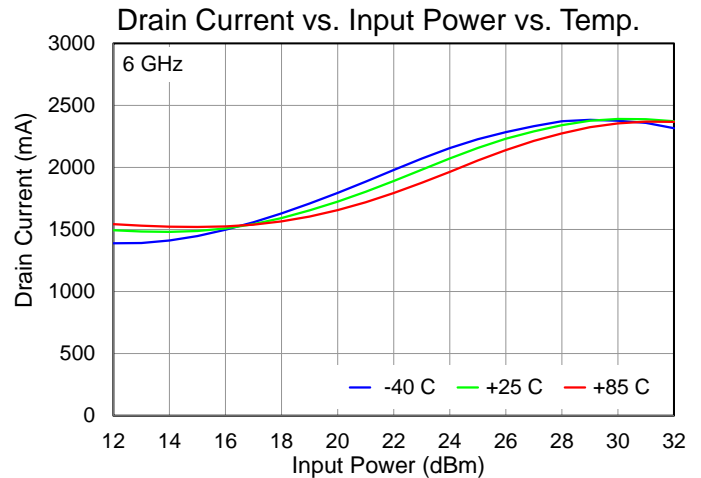
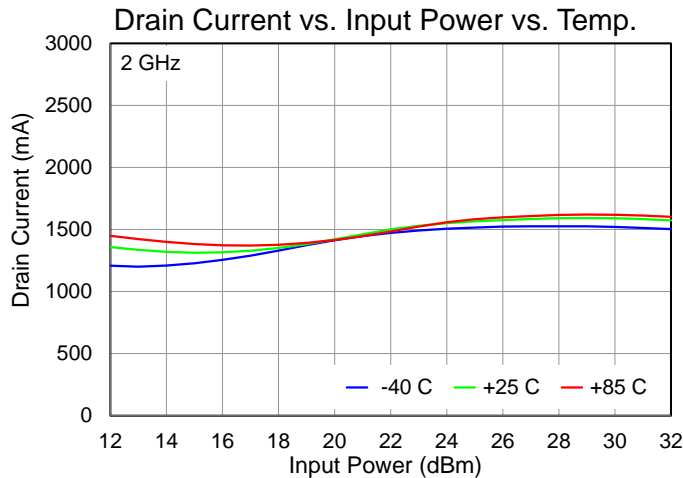

Performance Plots – Large Signal

Test conditions unless otherwise noted: CW, $V_D = 22\text{ V}$, $I_{DQ} = 1680\text{ mA}$, $P_{IN} = 27\text{ dBm}$, $T_{BASE} = +25\text{ }^\circ\text{C}$

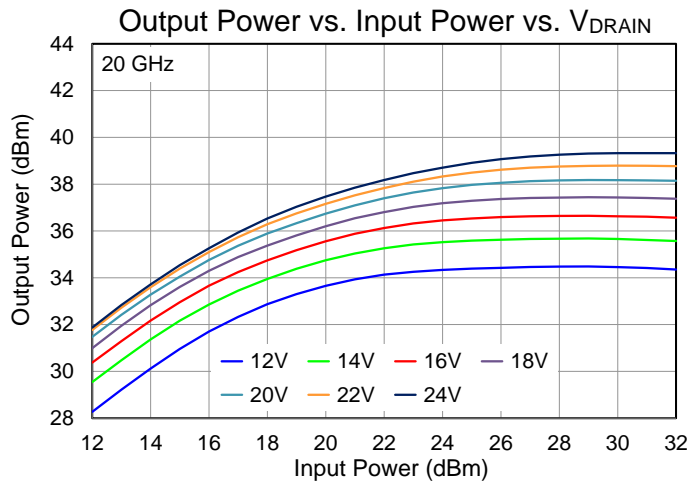
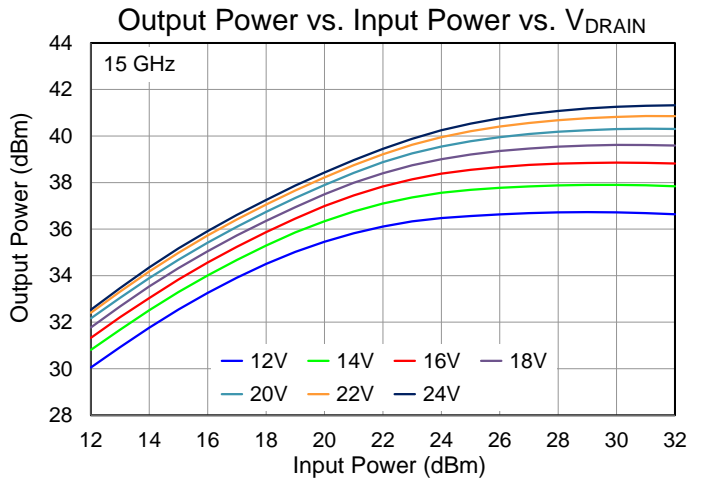
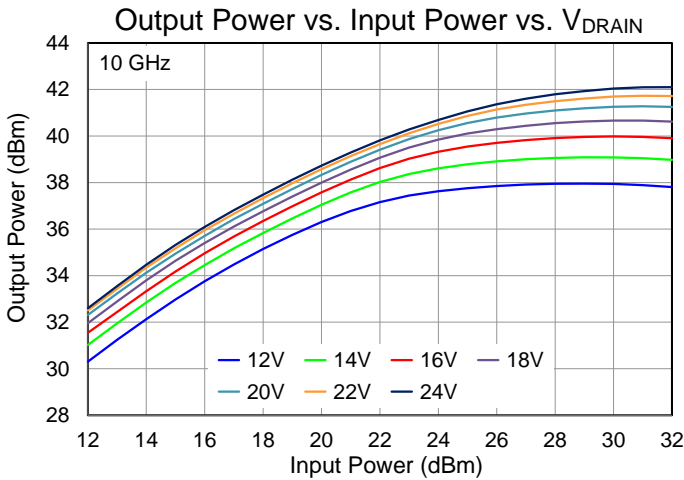
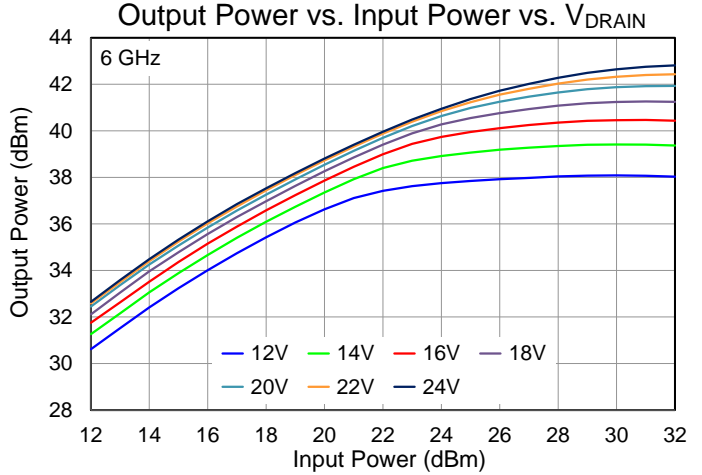
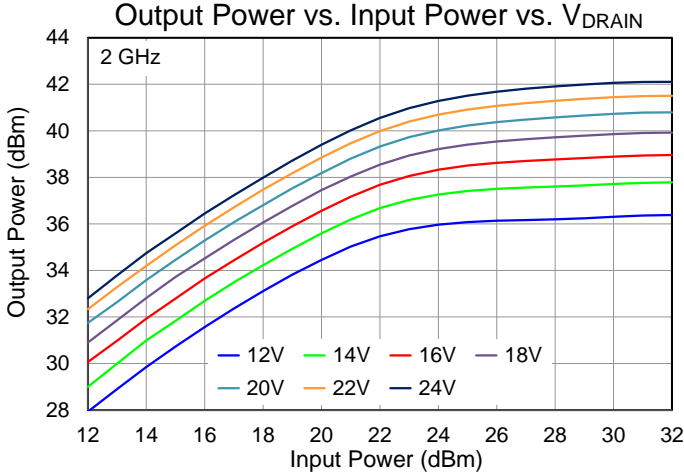

Performance Plots – Large Signal

Test conditions unless otherwise noted: CW, $V_D = 22\text{ V}$, $I_{DQ} = 1680\text{ mA}$, $P_{IN} = 27\text{ dBm}$, $T_{BASE} = +25\text{ }^\circ\text{C}$

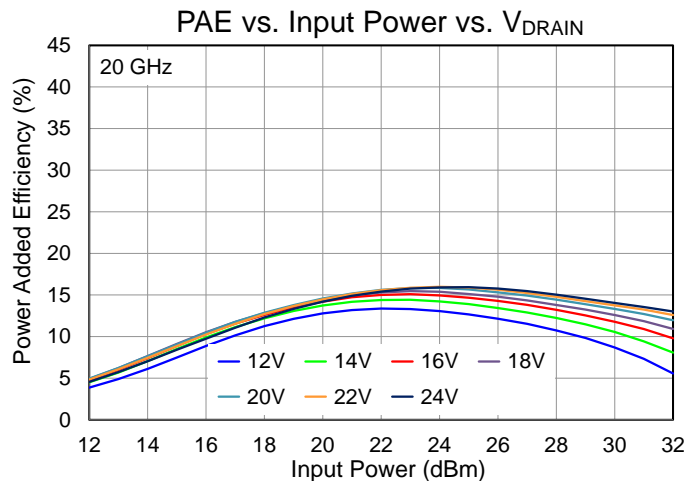
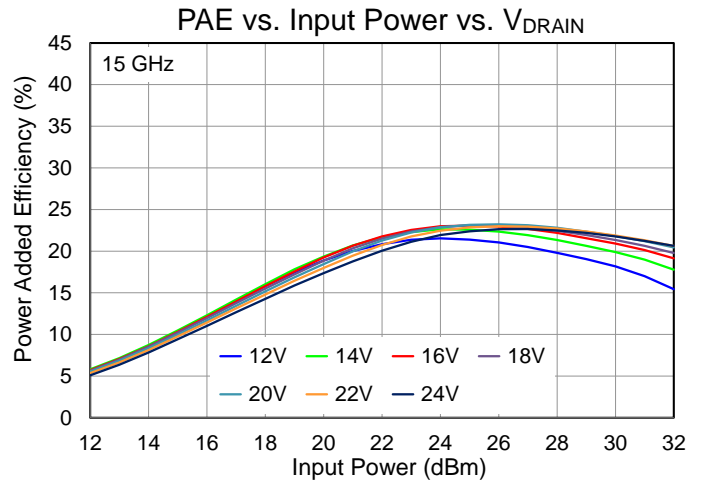
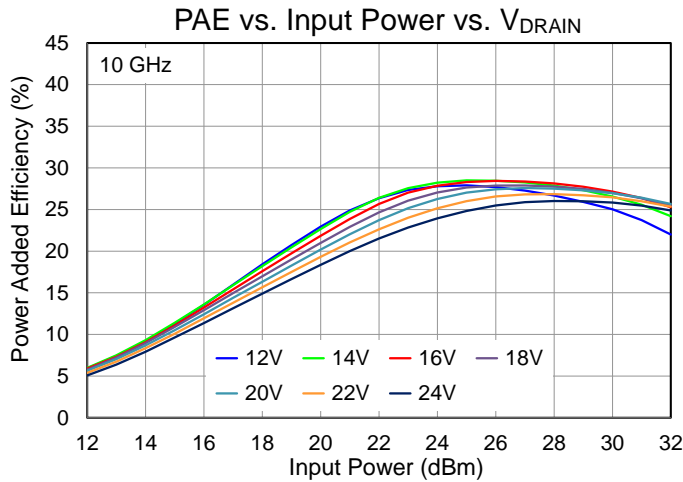
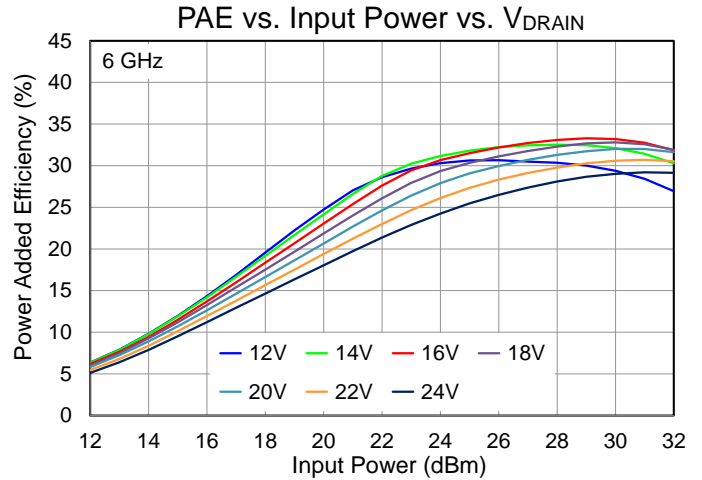
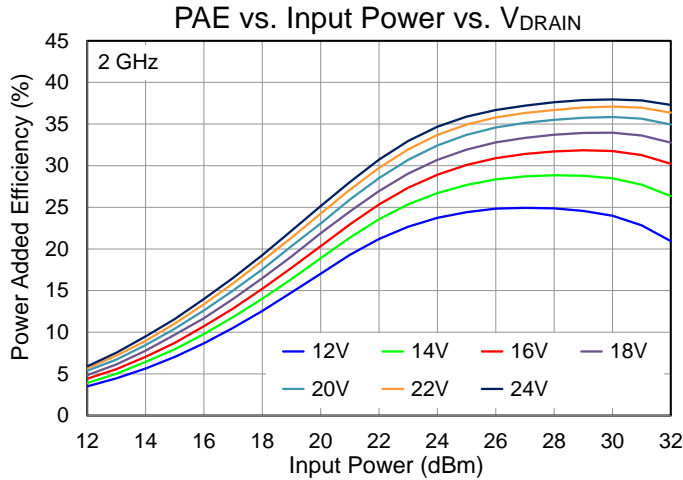

Performance Plots – Large Signal

Test conditions unless otherwise noted: CW, $V_D = 22\text{ V}$, $I_{DQ} = 1680\text{ mA}$, $P_{IN} = 27\text{ dBm}$, $T_{BASE} = +25\text{ }^\circ\text{C}$

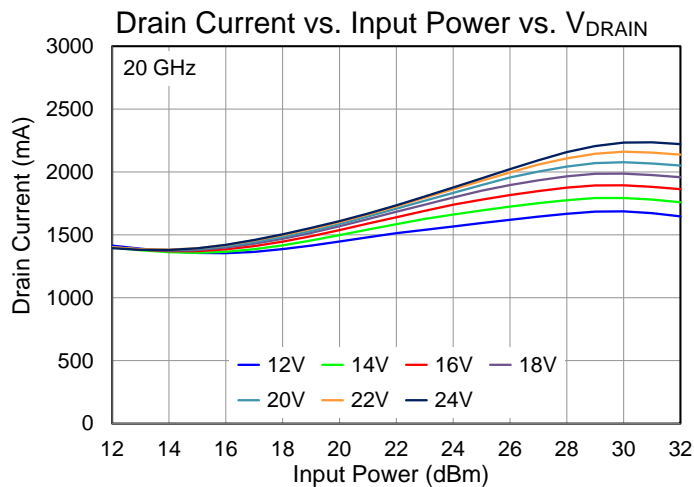
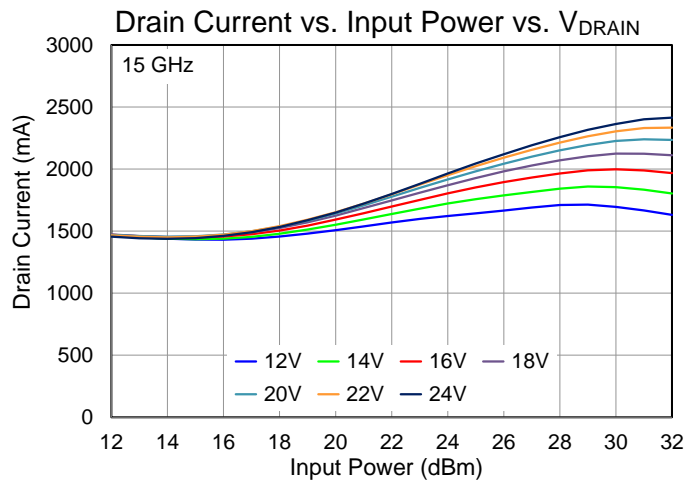
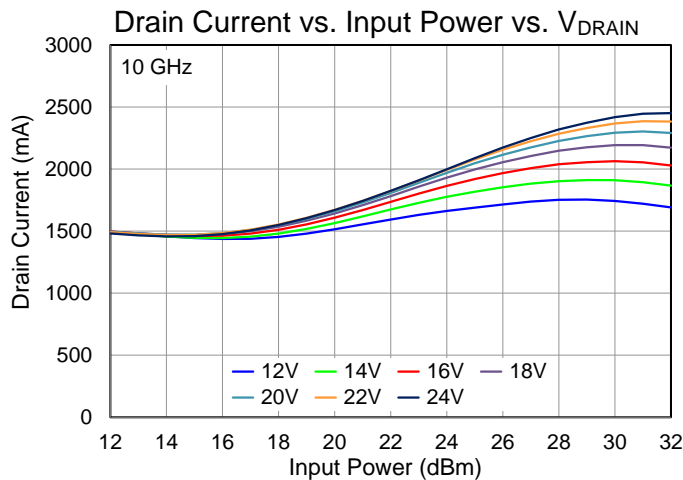
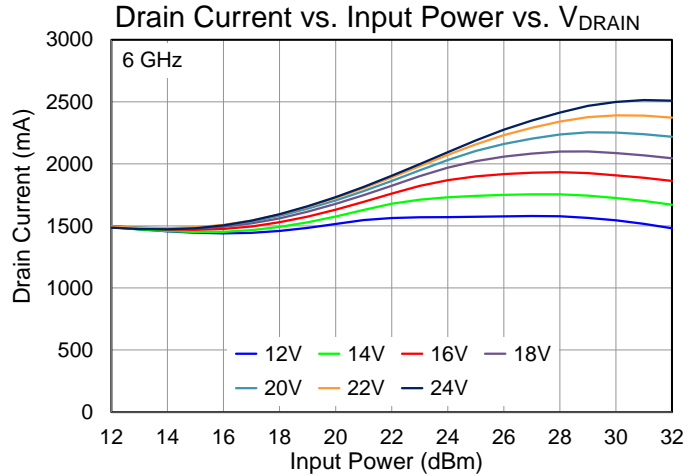
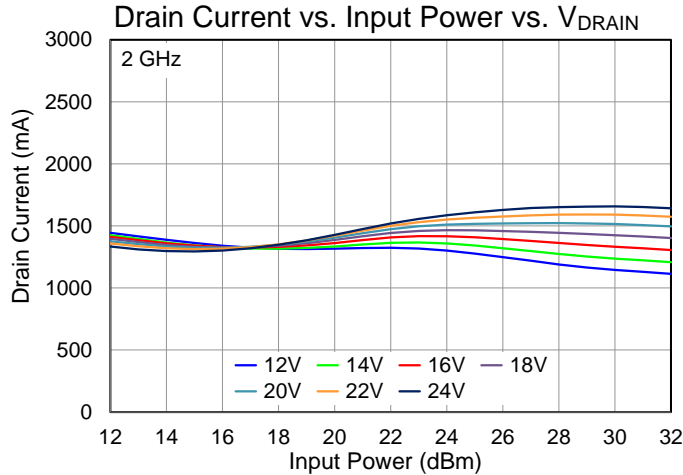

Performance Plots – Large Signal

Test conditions unless otherwise noted: CW, $V_D = 22\text{ V}$, $I_{DQ} = 1680\text{ mA}$, $P_{IN} = 27\text{ dBm}$, $T_{BASE} = +25\text{ }^\circ\text{C}$

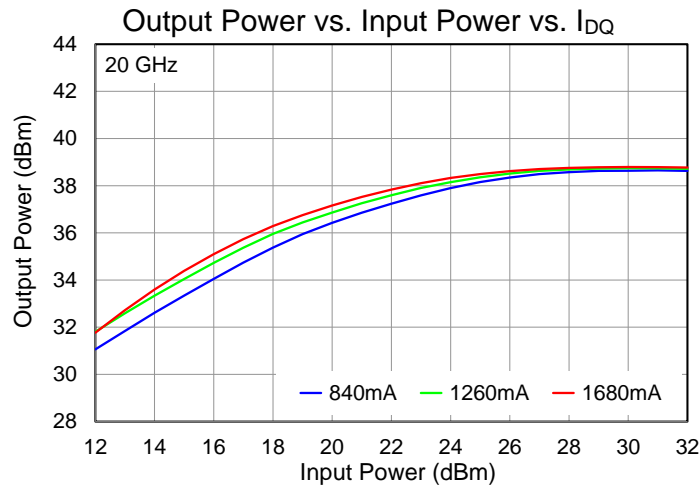
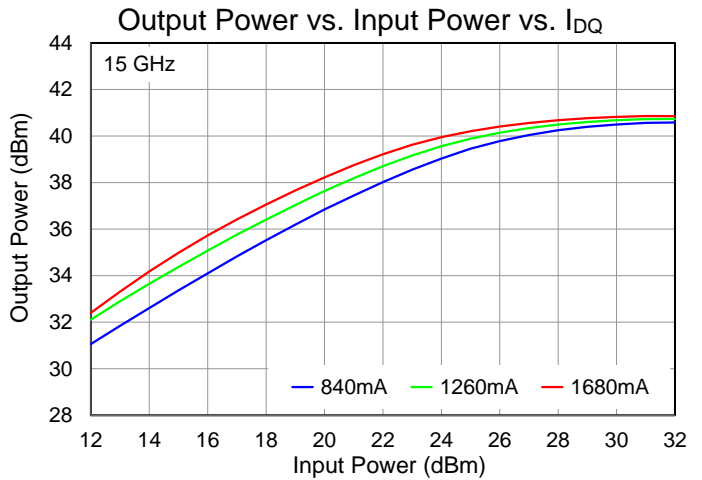
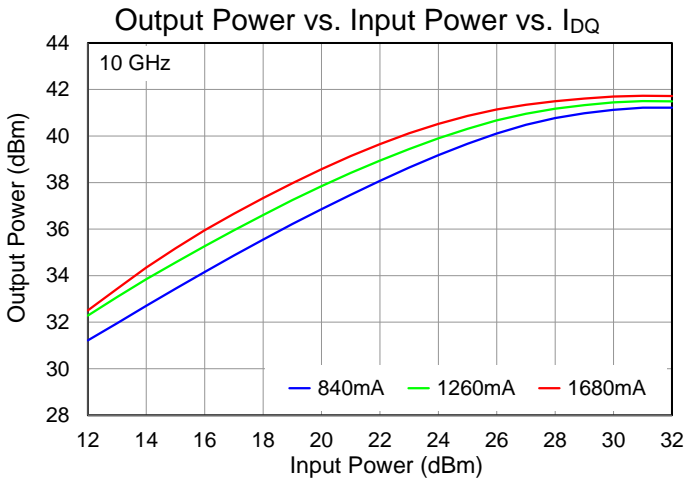
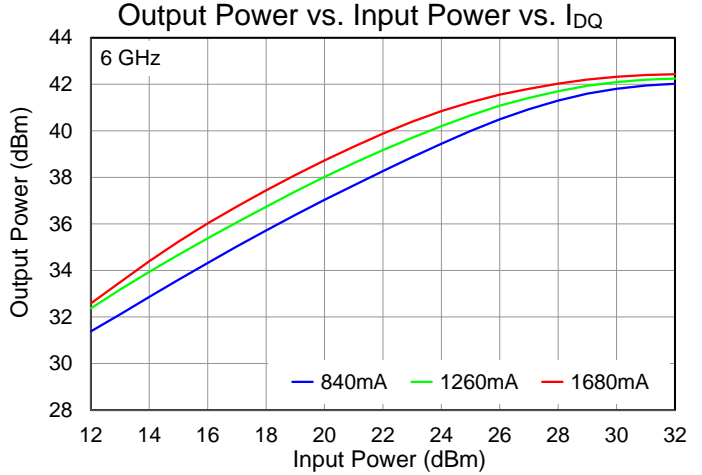
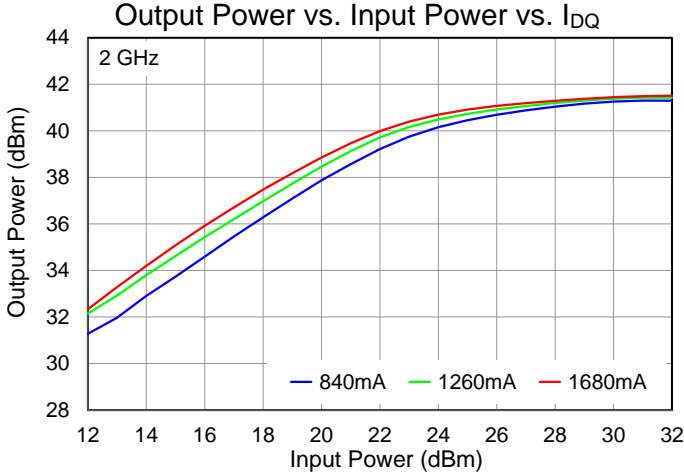

Performance Plots – Large Signal

Test conditions unless otherwise noted: CW, $V_D = 22\text{ V}$, $I_{DQ} = 1680\text{ mA}$, $P_{IN} = 27\text{ dBm}$, $T_{BASE} = +25\text{ }^\circ\text{C}$

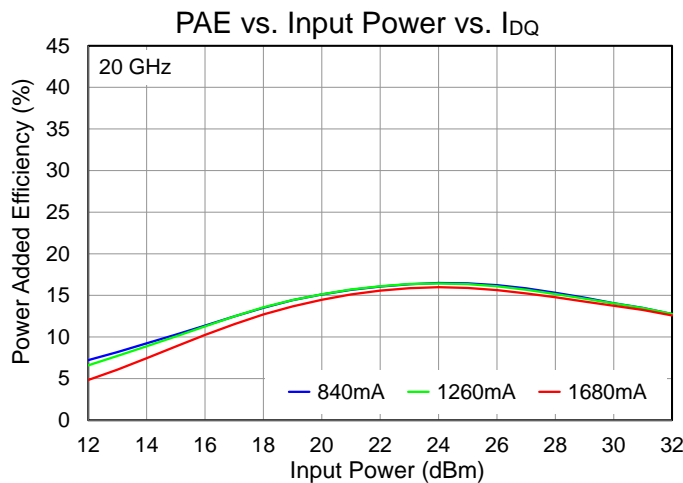
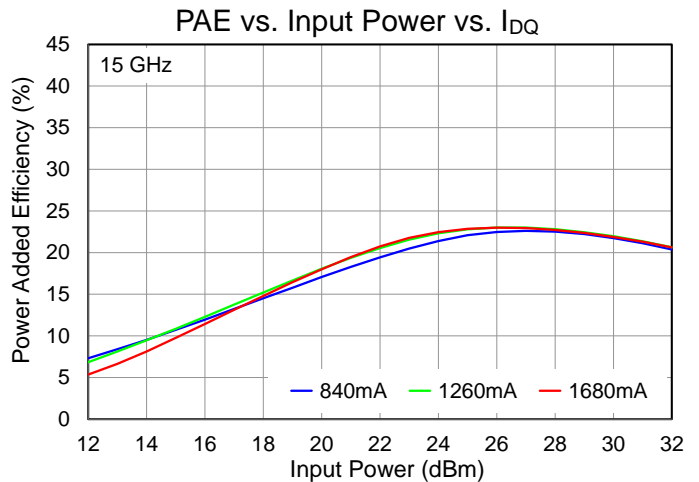
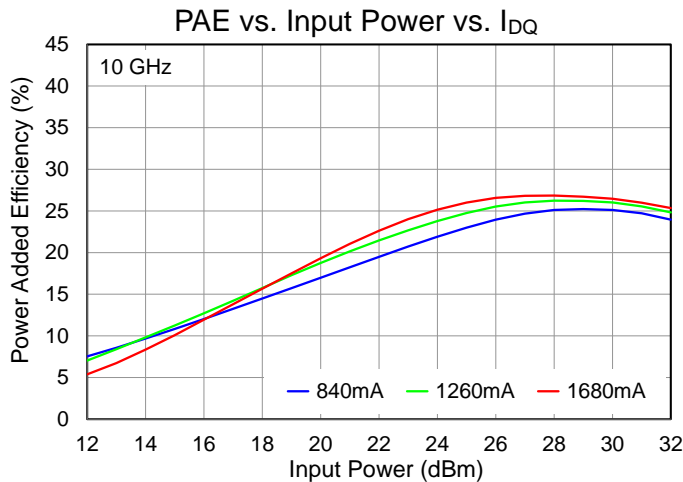
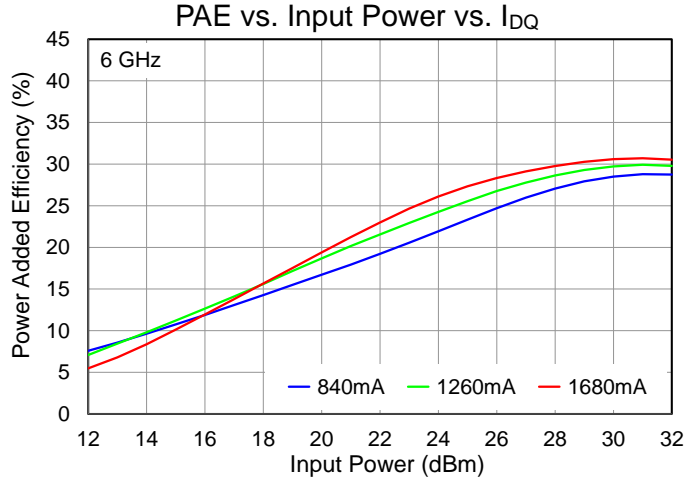
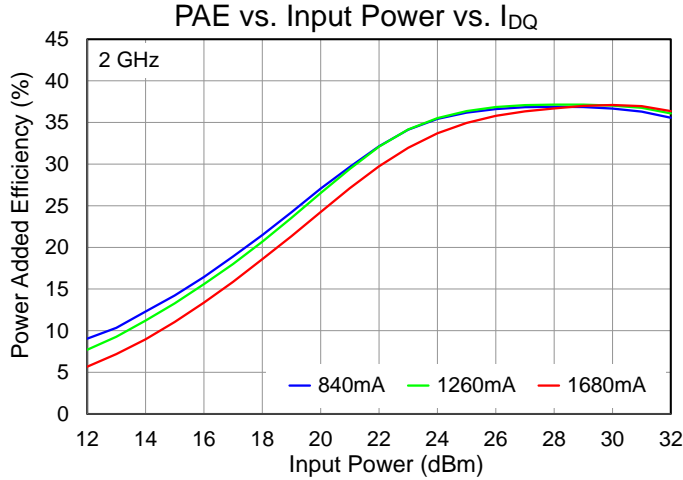

Performance Plots – Large Signal

Test conditions unless otherwise noted: CW, $V_D = 22\text{ V}$, $I_{DQ} = 1680\text{ mA}$, $P_{IN} = 27\text{ dBm}$, $T_{BASE} = +25\text{ }^\circ\text{C}$

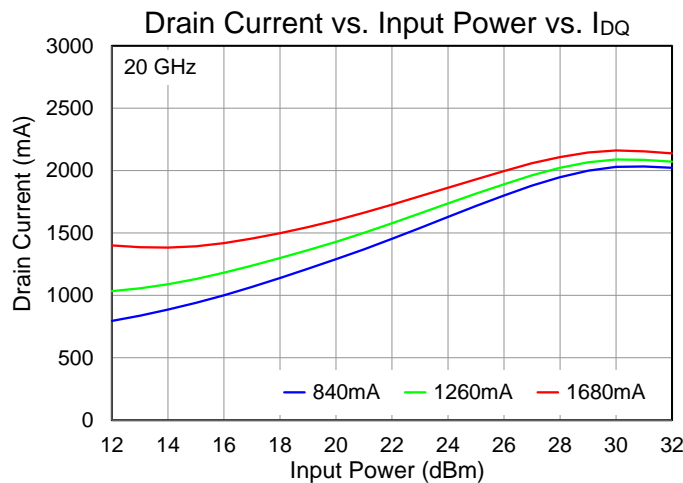
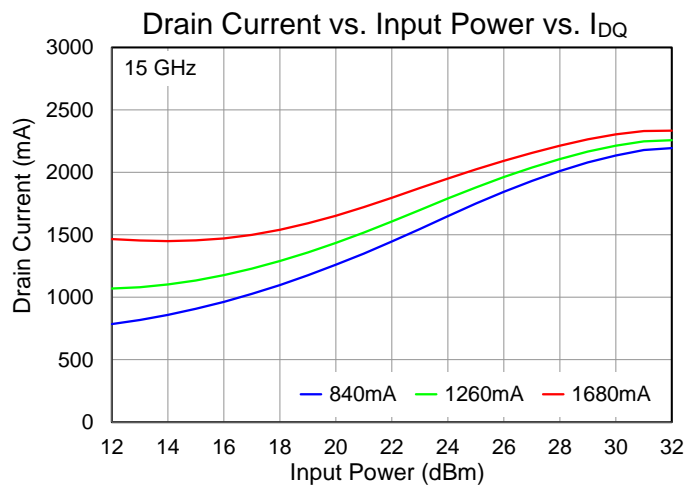
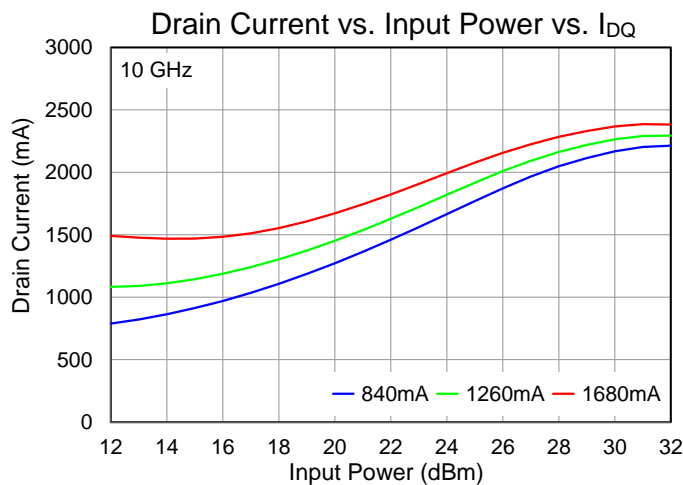
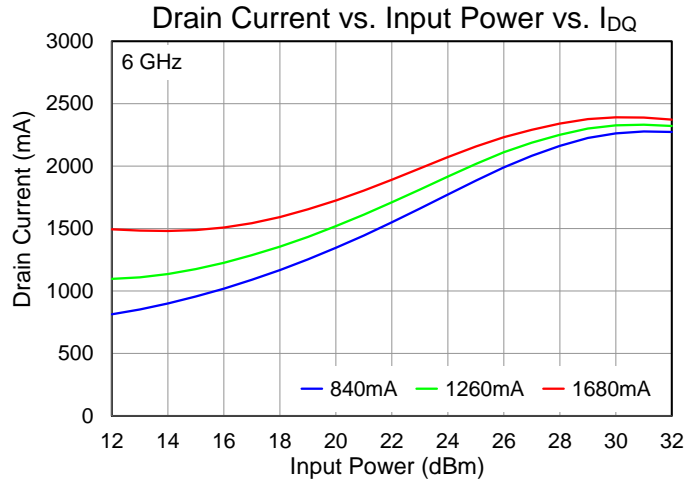
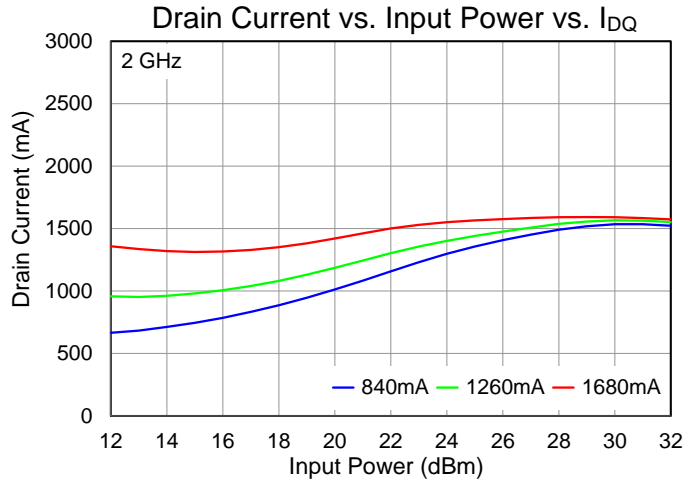

Performance Plots – Linearity

Test conditions unless otherwise noted: CW, $V_D = 22\text{ V}$, $I_{DQ} = 1680\text{ mA}$, Tone Spacing = 100 MHz, $T_{BASE} = +25\text{ }^\circ\text{C}$

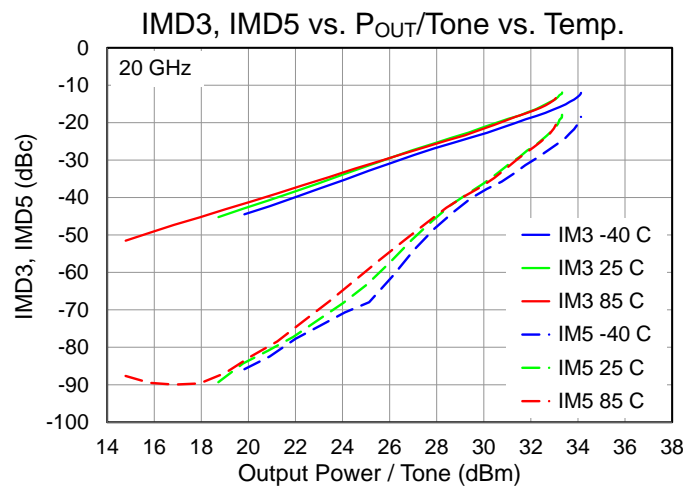
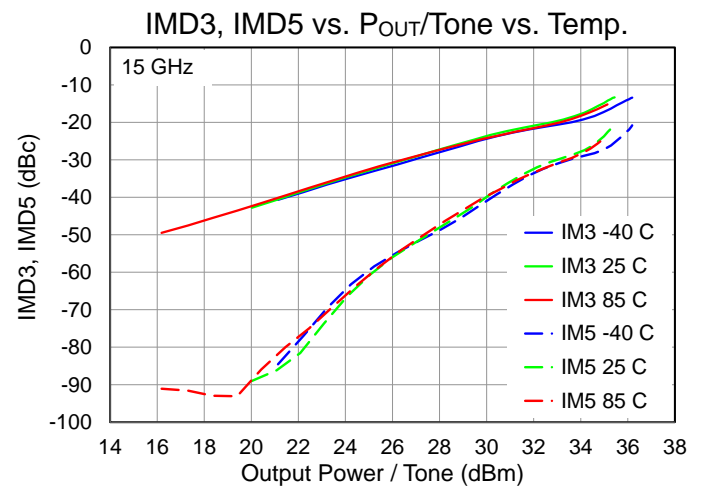
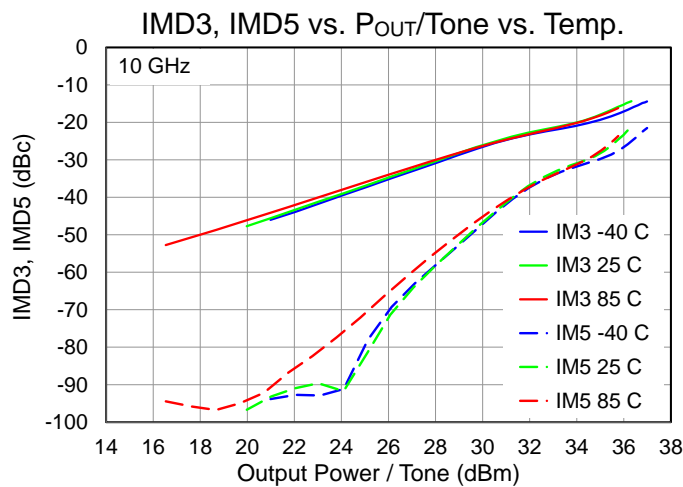
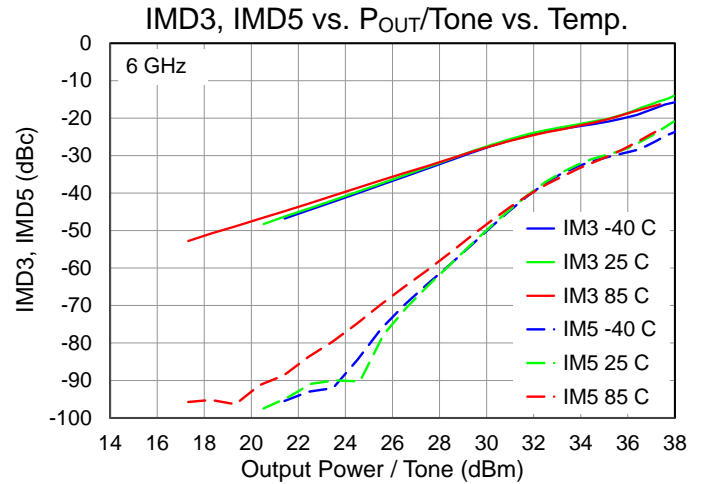
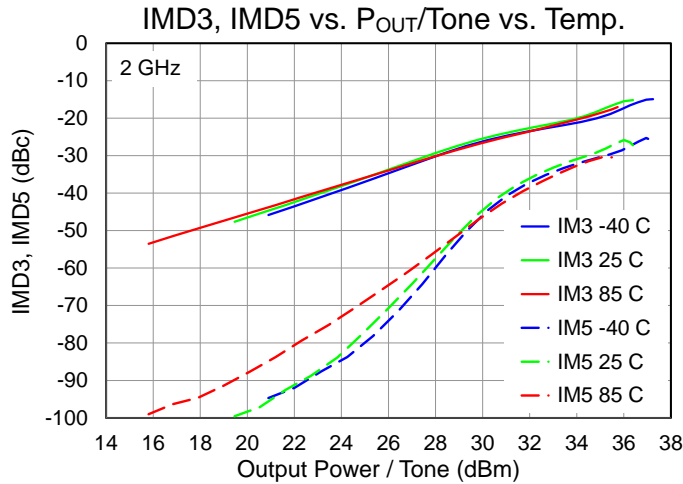

Performance Plots – Linearity

Test conditions unless otherwise noted: CW, $V_D = 22\text{ V}$, $I_{DQ} = 1680\text{ mA}$, Tone Spacing = 100 MHz, $T_{BASE} = +25\text{ }^\circ\text{C}$

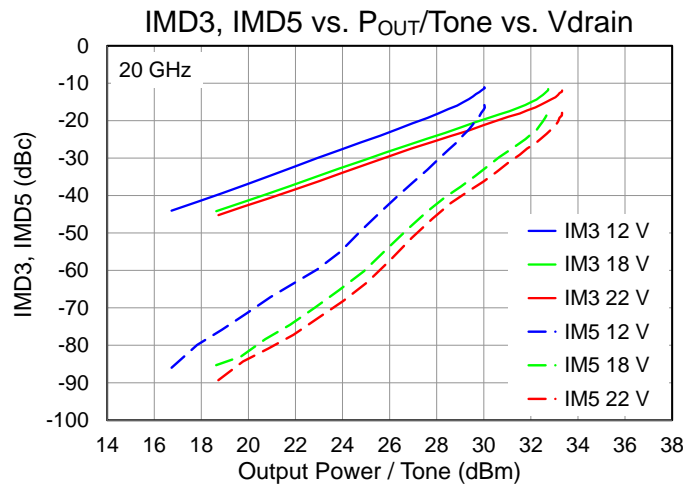
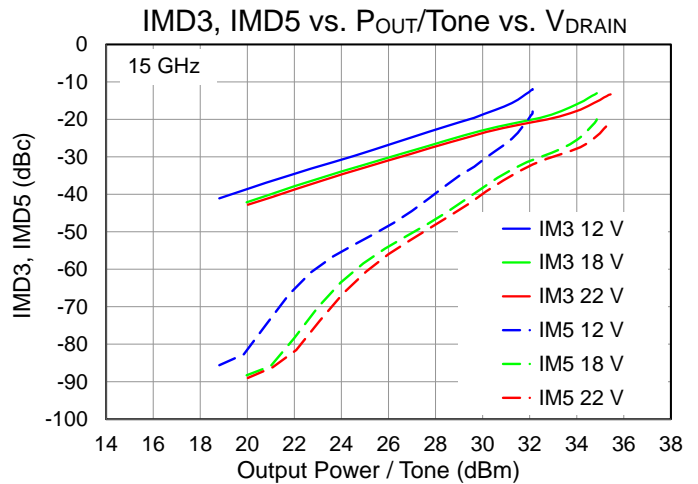
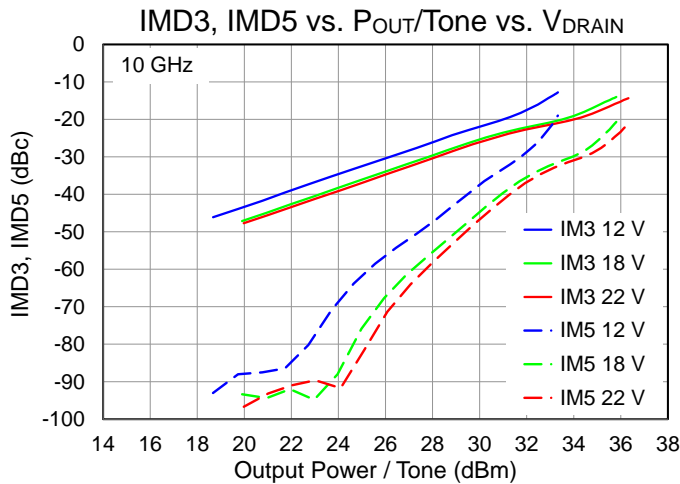
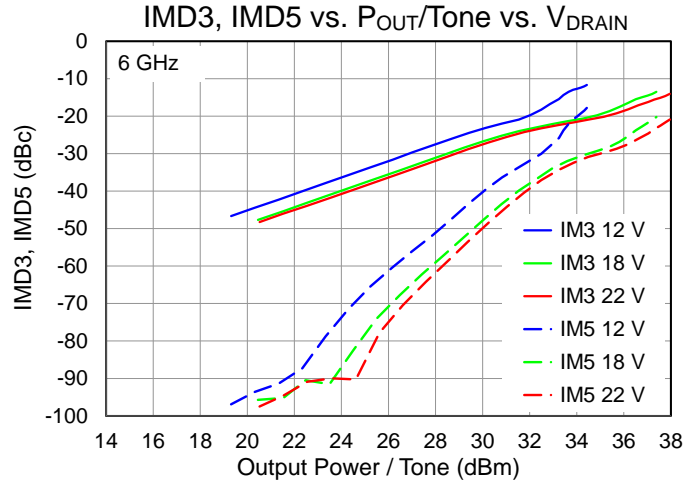
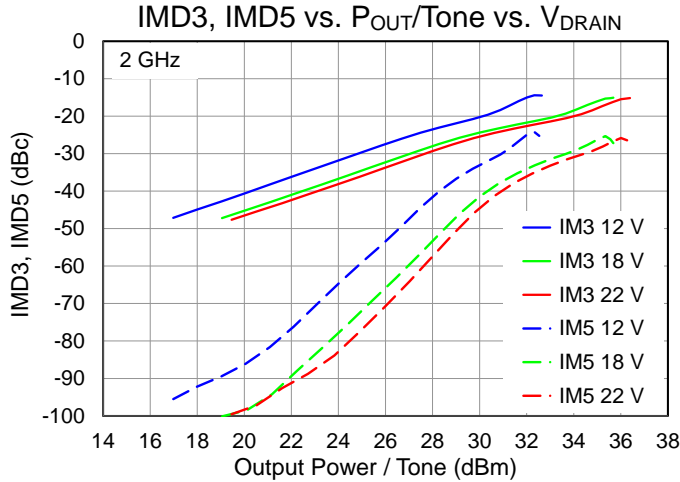

Performance Plots – Linearity

Test conditions unless otherwise noted: CW, $V_D = 22\text{ V}$, $I_{DQ} = 1680\text{ mA}$, Tone Spacing = 100 MHz, $T_{BASE} = +25\text{ }^\circ\text{C}$

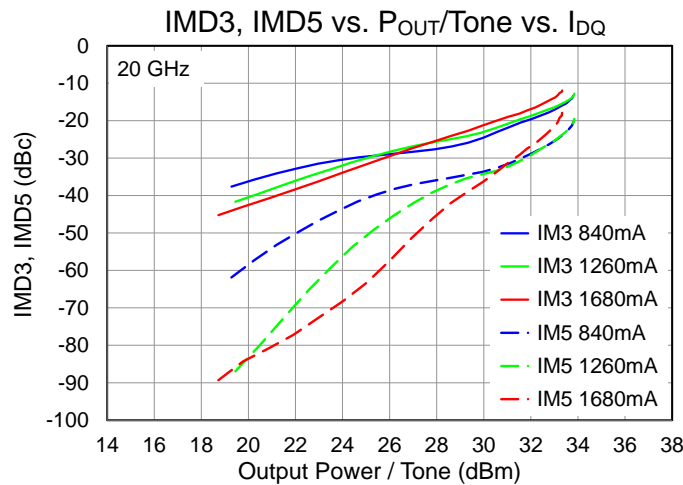
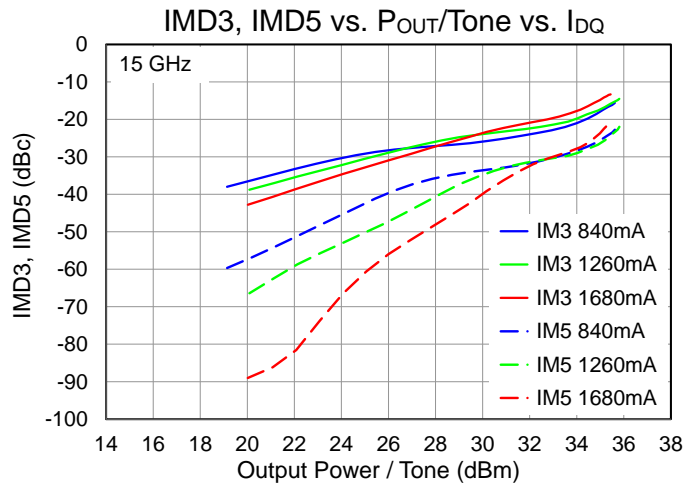
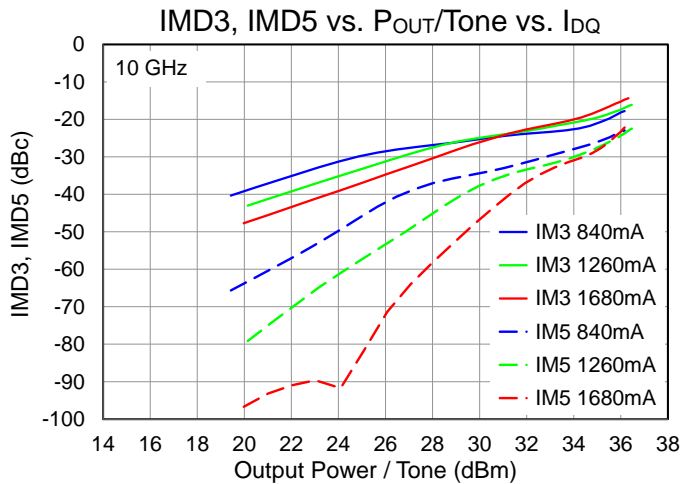
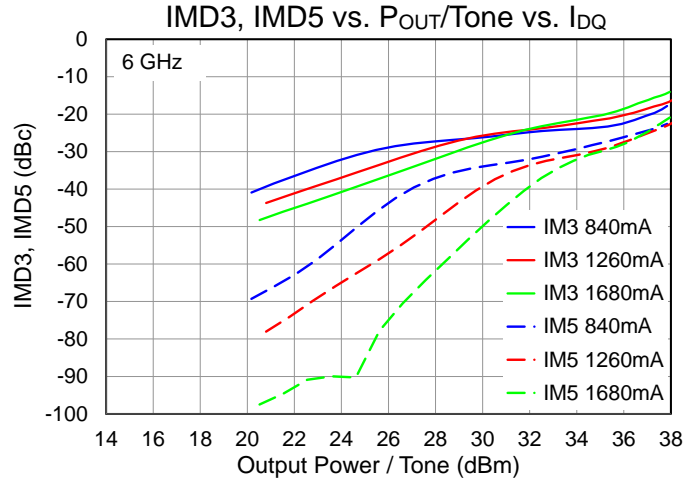
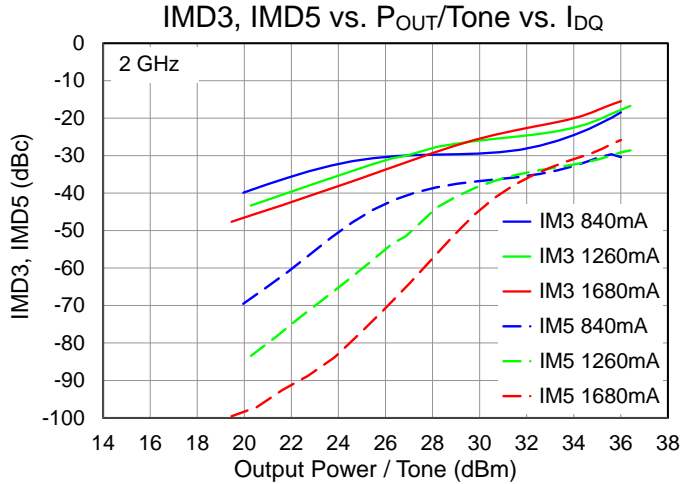

Performance Plots – Harmonics

Test conditions unless otherwise noted: CW, $V_D = 22\text{ V}$, $I_{DQ} = 1680\text{ mA}$, $P_{IN} = 27\text{ dBm}$, $T_{BASE} = +25\text{ }^\circ\text{C}$

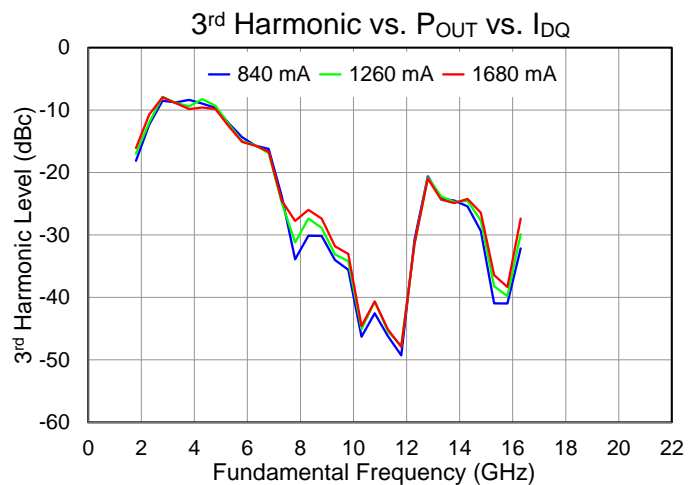
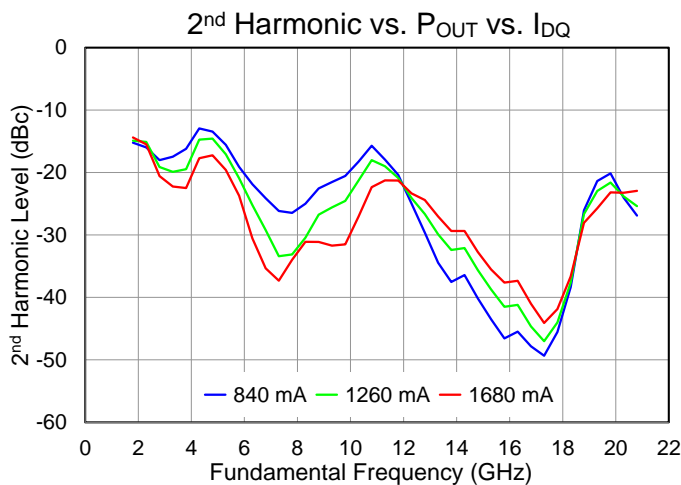
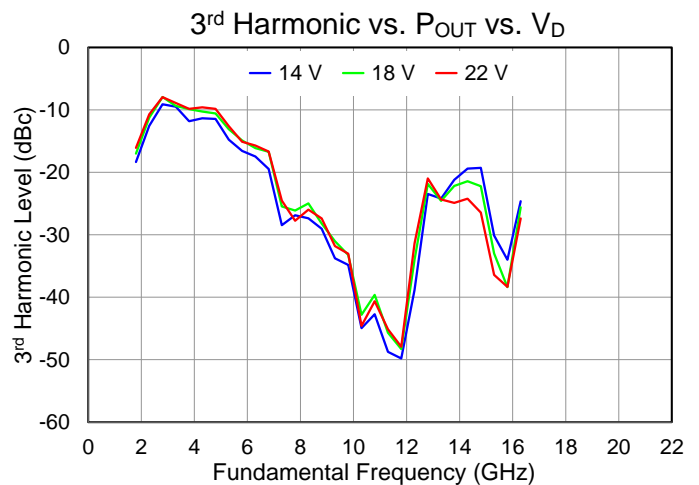
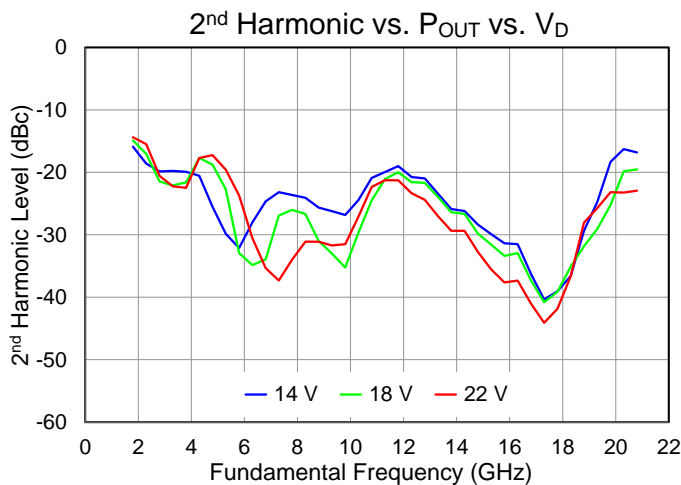
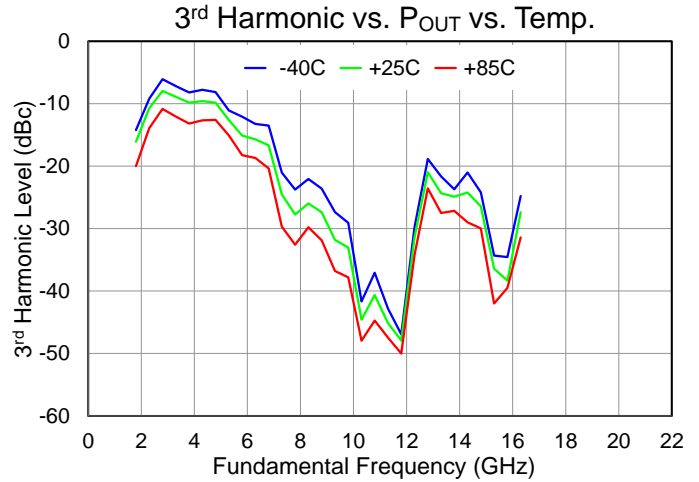
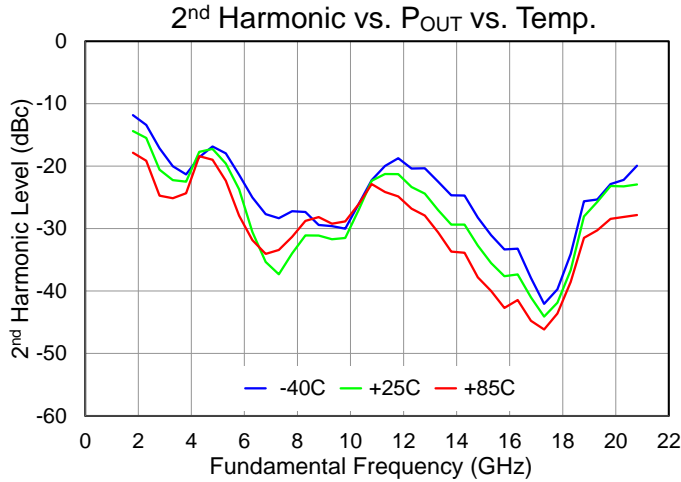

Thermal and Reliability Information

Parameter	Test Conditions	Value	Units
Thermal Resistance (θ_{JC}) ⁽¹⁾	T _{BASE} = 85 °C, V _D = 22 V, I _{DQ} = 1680 mA, No RF (quiescent DC operation)	2.83	°C/W
Channel Temperature, T _{CH} (Under RF) ⁽²⁾		189	°C
Thermal Resistance (θ_{JC}) ⁽¹⁾	T _{BASE} = 85 °C, V _D = 22 V, I _{DQ} = 1680 mA, Freq = 19 GHz, I _{D_Drive} = 2 A, P _{IN} = 27 dBm, P _{OUT} = 38.4 dBm,	2.82	°C/W
Channel Temperature, T _{CH} (Under RF) ⁽²⁾		191	°C

Notes:

1. Thermal resistance determined to the back of package (85 °C)
2. Channel temperature indicated is an IR scan equivalent temperature. Thermal resistance is calculated using this value. Additional information can be found in the Qorvo Applications Note “GaN Device TCHMAX Theta-JC and Reliability Estimates”, located here <https://www.qorvo.com/products/d/da006480>

Dissipated Power

Test conditions, unless otherwise noted:
V_D = 22 V, I_{DQ} = 1680 mA, T_{BASE} = 25 °C, P_{IN} = 27 dBm

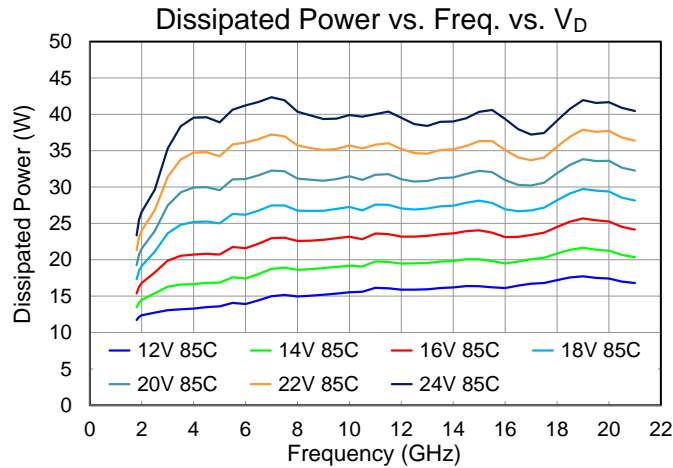

Applications Circuit (Pulse)

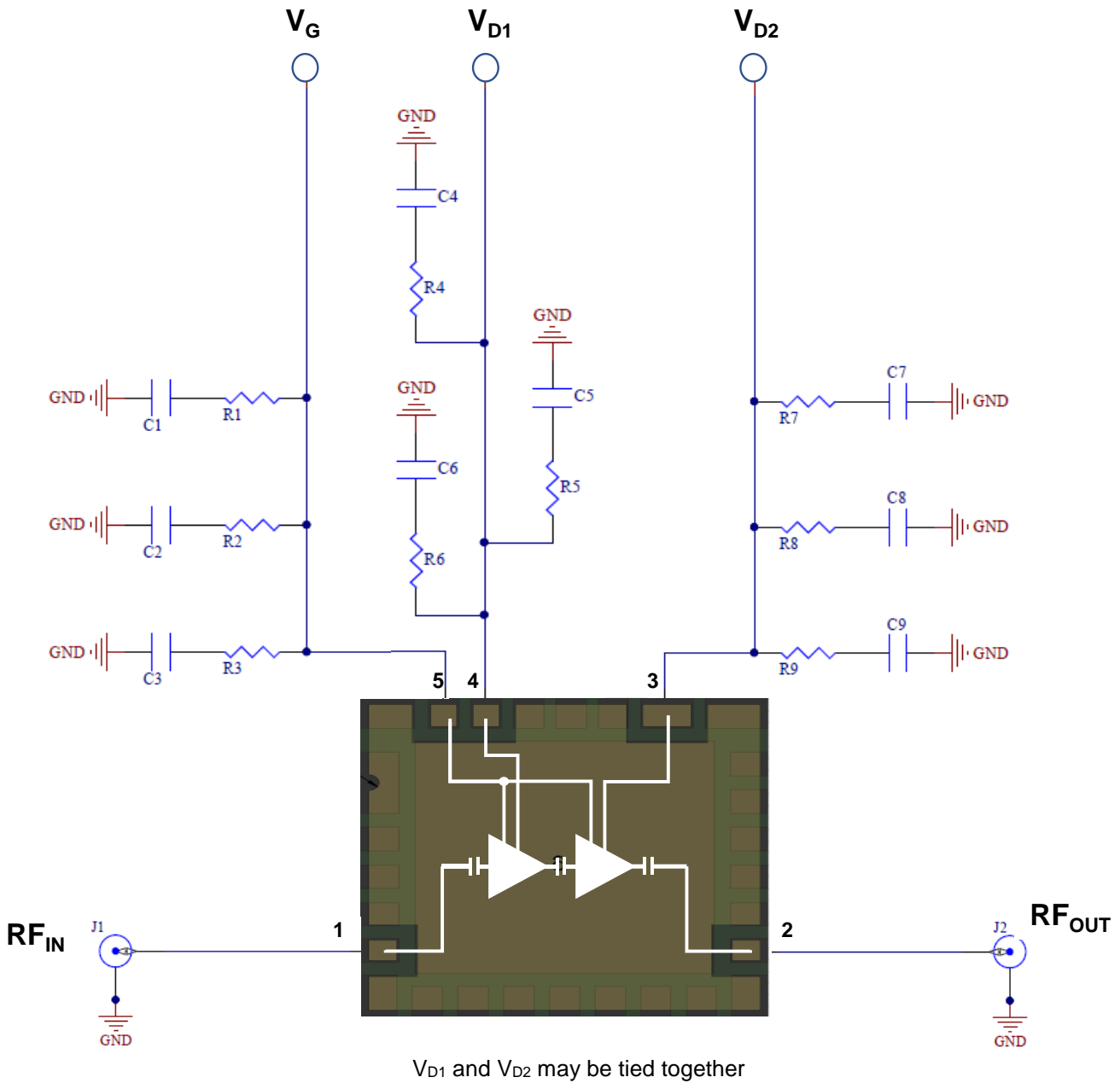

Bias-Up Procedure

1. Set I_D limit to 2840 mA, I_G limit to 10 mA
2. Set V_G to -4 V
4. Set V_D +22 V
5. Adjust V_G more positive until $I_{DQ} = 1680$ mA
6. Apply RF signal

Bias-Down Procedure

1. Turn off RF signal
2. Reduce V_G to -4.0 V. Ensure $I_{DQ} \sim 0$ mA
3. Set V_D to 0 V
4. Turn off V_D supply
5. Turn off V_G supply

Application Evaluation Board

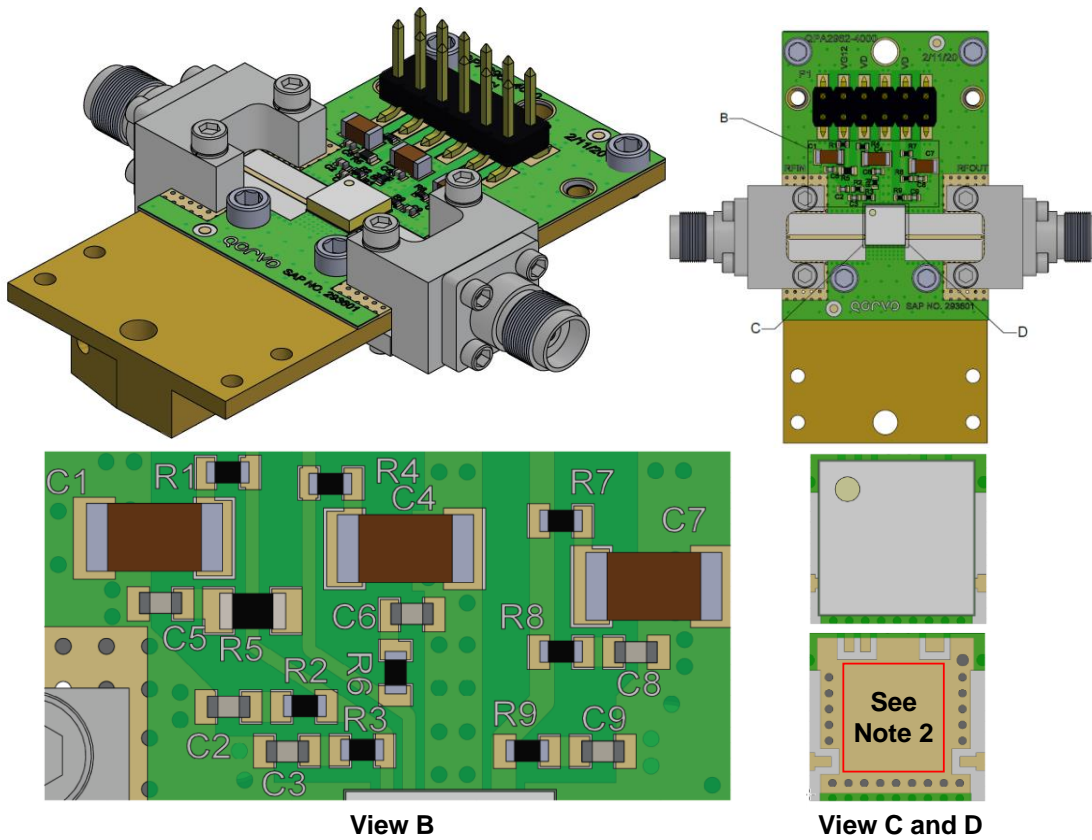

Notes:

1. RF PCB is Rogers 6035HTC, 0.010" thick; copper cladding is ½ oz. copper both sides, plated to 1 oz
2. Populated with high density vias; vias are to be non-conductive epoxy filled, over-plated, and planarized

Bill of Materials

Reference Des.	Value	Description	Manuf.	Part Number
C1, C4, C7	10 uF	CAP, 10uF, ±20%, 50V, X5R, 1206	Various	
C2, C3, C5, C6, C8, C9	0.1 uF	CAP, 0.1uF, ±10%, 50V, X7R, 0402	Various	
R2, R3, R6, R7, R8, R9	0 Ω	RES, 0 OHM, JMPR, 0402	Various	
R1, R4	10 Ω	RES, 5.1 OHM, 5%, 50V, 0402	Various	
R5	0 Ω	RES, 0 OHM, 0.1W, 0603	Various	
H1	-	Header, connector, 2x6, 0.100", SMD		
J1, J2	-	Connector, Female, End Launch, 2.9mm	Southwest Microwave	1092-01A-5
S1 – S4	-	Screw, cap, socket head, 2-56x1/8"		
PCB	-	Rogers 4003C, 8 mil dielectric, 1 oz. copper (gold plated), 2 layers	Rogers Corp.	Custom
Carrier	-	T-Carrier, Copper C110, 0.990 x 2.000 x 0.275"		Custom
Solder	-	Paste, solder, syntech, Sn62/Pb36/Ag2		

Mechanical Information

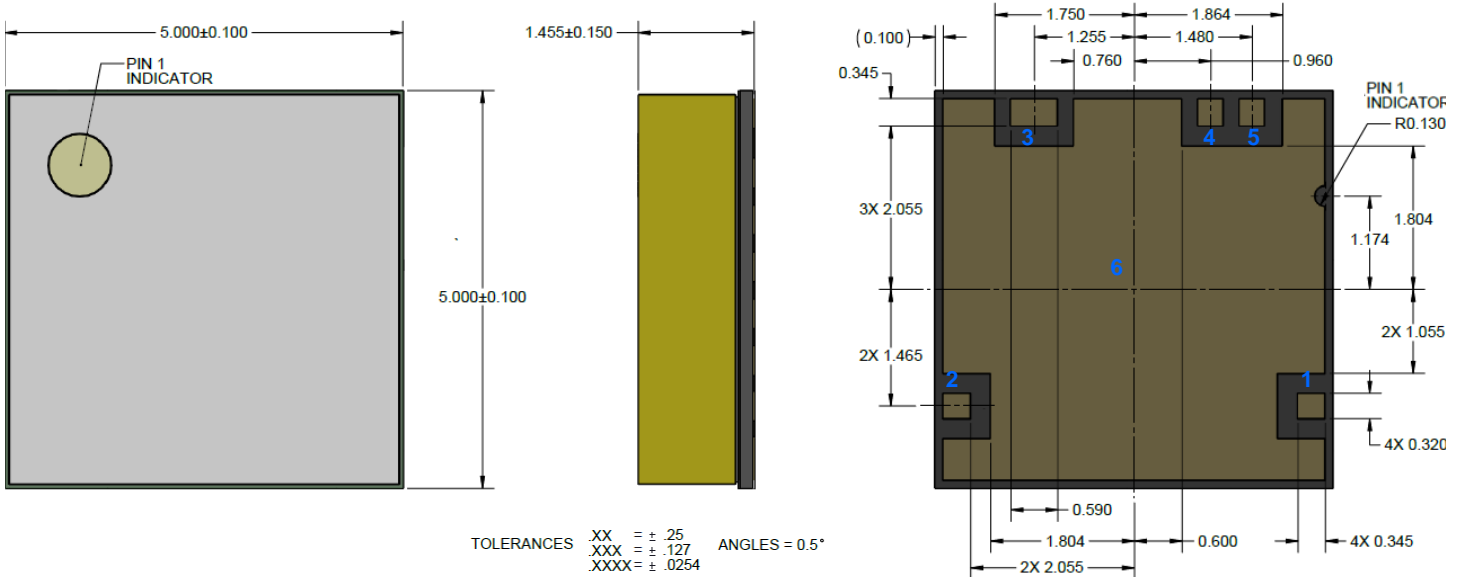

Notes: unless otherwise specified;

1. Dimensions: millimeters (mm)
2. Package is air cavity, leads are gold (Au) plated, base is laminate; Part is epoxy sealed
3. Marking: YY is calendar year; WW is assembly week; MXXX is batch ID

Pin Description

Pin Number	Symbol	Description
1	RF _{IN}	RF input. 50 Ohms. DC blocked.
2	RF _{OUT}	RF output. 50 Ohms. DC blocked.
3	V _{D2}	Drain voltage, stage 2. Bypass network required; refer to page 22.
4	V _{D1}	Drain voltage, stage 1. Bypass network required; refer to page 22.
5	V _G	Gate voltage, stage 1 and 2. Bypass network required; refer to page 22.
6	Center Pad	Ground connection
Non-assigned pins		Ground. Connect to PCB ground

Tape and reel Information

Standard T/R size = 250 pieces on a 7" reel

Dimensions: millimeters (mm)

Tolerances unless otherwise noted: .X = ± .2; .XX = ± .10

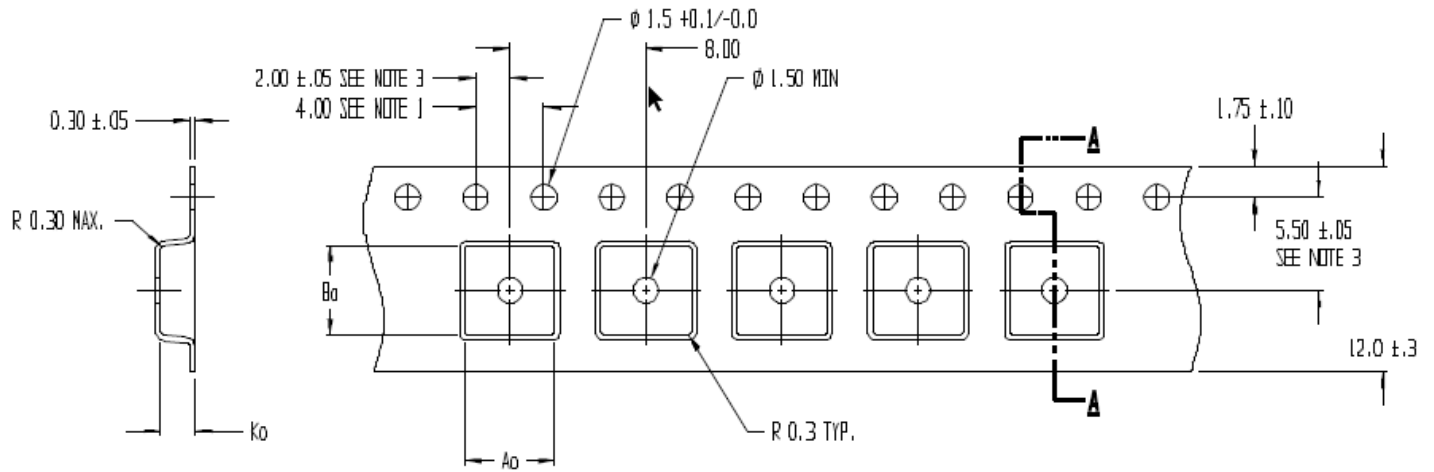

A₀ = 5.30
B₀ = 5.30
K₀ = 2.00

NOTES:

1. 10 SPROCKET HOLE PITCH CUMULATIVE TOLERANCE ±0.2
2. CAMBER IN COMPLIANCE WITH EIA 481
3. POCKET POSITION RELATIVE TO SPROCKET HOLE MEASURED AS TRUE POSITION OF POCKET, NOT POCKET HOLE

Solderability

Compatible with lead-free soldering processes with 260°C peak reflow temperature.

This package is air-cavity and non-hermetic, and therefore cannot be subjected to aqueous washing. The use of no-clean solder to avoid washing after soldering is highly recommended.

Contact plating: Ni-Au

Solder rework not recommended

Recommended Soldering Temperature Profile

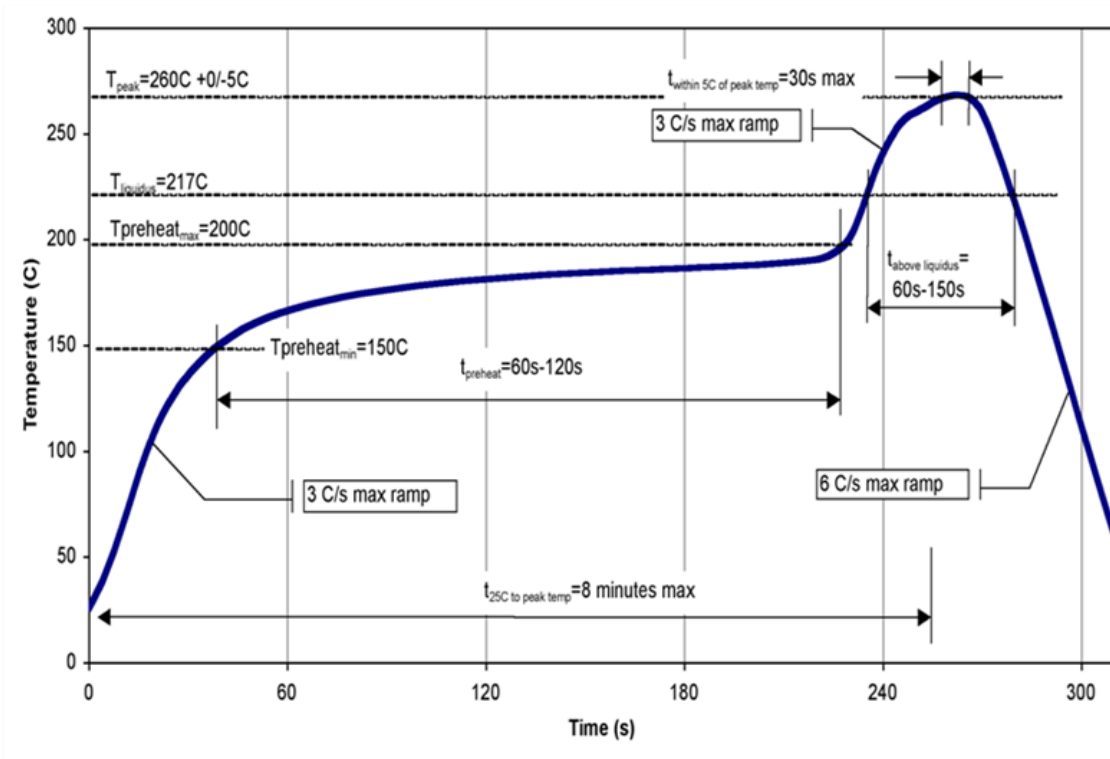

Handling Precautions

Parameter	Rating	Standard
ESD – Human Body Model (HBM)	1A	ANSI/ESD/JEDEC JS-001
ESD – Charged Device Model (CDM)	C3	ANSI/ESD/JEDEC JS-002
MSL – Moisture Sensitivity Level	3	IPC/JEDEC J-STD-020



Caution!
ESD-Sensitive Device

RoHS Compliance

This product is compliant with the 2011/65/EU RoHS directive (Restrictions on the Use of Certain Hazardous Substances in Electrical and Electronic Equipment), as amended by Directive 2015/863/EU.

This product also has the following attributes:

- Lead Free
- Antimony Free
- TBBP-A (C₁₅H₁₂Br₄O₂) Free
- SVHC Free
- PFOS Free

Contact Information

For the latest specifications, additional product information, world

Web: www.qorvo.com

Tel: 1-844-890-8163

Email: customer.support@qorvo.com

Important Notice

The information contained herein is believed to be reliable; however, Qorvo makes no warranties regarding the information contained herein and assumes no responsibility or liability whatsoever for the use of the information contained herein. All information contained herein is subject to change without notice. Customers should obtain and verify the latest relevant information before placing orders for Qorvo products. The information contained herein or any use of such information does not grant, explicitly or implicitly, to any party any patent rights, licenses, or any other intellectual property rights, whether with regard to such information itself or anything described by such information. **THIS INFORMATION DOES NOT CONSTITUTE A WARRANTY WITH RESPECT TO THE PRODUCTS DESCRIBED HEREIN, AND QORVO HEREBY DISCLAIMS ANY AND ALL WARRANTIES WITH RESPECT TO SUCH PRODUCTS WHETHER EXPRESS OR IMPLIED BY LAW, COURSE OF DEALING, COURSE OF PERFORMANCE, USAGE OF TRADE OR OTHERWISE, INCLUDING THE IMPLIED WARRANTIES OF MERCHANTABILITY AND FITNESS FOR A PARTICULAR PURPOSE.**

Without limiting the generality of the foregoing, Qorvo products are not warranted or authorized for use as critical components in medical, life-saving, or life-sustaining applications, or other applications where a failure would reasonably be expected to cause severe personal injury or death.

© 2020 Qorvo US, Inc. All rights reserved. This document is subject to copyright laws in various jurisdictions worldwide and may not be reproduced or distributed, in whole or in part, without the express written consent of Qorvo US, Inc.