



AIRPAX® | QAS/QAL/QFS/QFL Series

Quick-Action Fuses

INTRODUCTION

The Airpax™ QAS, QAL, QFS, QFL product lines feature L-type terminals and carry a rated voltage of up to 600 VAC and 500 VDC, 300A max, 100K AIC. They feature a high current-limiting effect and superior quick-action fusing performance, excellent arc-suppressing performance, and reliable breaking action. Because of their low power loss, they save energy and also feature low surge voltage at the breaking point. Superior non-degradation characteristics make it ideal for motors subject to extreme load variations.

Typical applications include inverters, arc welders, rectifiers, CNC equipment, battery circuits, and other protective applications.





FEATURES

- L-type terminal construction for easy installation
- RU, cRUus, and TÜV approved products available
- Large breaking capacity (100kA)
- Low I²t value, semiconductor protection balance can be easily obtained
- Compact and lightweight
- Resistant to repetitive currents
- Excellent current-limiting characteristics
- Low power loss

SPECIFICATIONS

Maximum Rated Current / Voltage	10A to 300A (250-600VAC; 300-500VDC)
Breaking Capacity	100kA at 250VAC and 600 VAC, 10kA at 300 VDC and 500 VDC
Power Loss	1W to 43W
Connecting Bar	0.016 to 0.310 in ² (10 to 200 mm ²)
I²t (A²S)x10³	Fusing = .009 to 14 Operating at 250VAC = .04 to 102 Operating at 600VAC = .6 to 175

OPTIONS

	Model	Rated Current (Amps)	Rated Voltage (Volts)	Breaking Capacity (VAC/VDC)
	QAS25U - <input type="checkbox"/>	20 to 100	250VAC / 300VDC	10kA / 10kA
	QAL25U - <input type="checkbox"/>	75 to 300	250VAC / 300VDC	10kA / 10kA
	QAS60U - <input type="checkbox"/>	20 to 75	600VAC / 500VDC	100kA / 10kA
	QAL60U - <input type="checkbox"/>	100 to 300	600VAC / 500VDC	100kA / 10kA
	QFS25U - <input type="checkbox"/>	10 to 100	250VAC (cRUus, TÜV) 400VDC (cRUus)	10kA / 10kA
	QFL25U - <input type="checkbox"/>	75 to 300	250VAC / 300VDC	10kA / 10kA
Indicator Fuse	Increase uptime by pinpointing open fuses with this instant visual identification			
Microswitch with Housing	Couple indicator fuse with a microswitch to create an integrated system, provides a signal to a panel or CPU to inform which fuse is blown.			
Fuse Holder	Increase mounting options by incorporating a fuse holder into your system			

*ЯU, UL Recognized Component: UL file # E174284 (250VAC/300VDC, 600VAC/500VDC)

*cЯUus, UL Recognized Component, U.S.A. & Canada: UL file # E174284 (250VAC/400VDC)

*TÜV Approved: TÜV file # J2150262, J2150268, J2150270, J2150271 (250VAC)

*These approvals are options available in this product family, general products do not carry these approvals. Review the Airpax catalog and website for further information on part numbers and product specifications for these approvals.

RATINGS								
Model *5	Rated Voltage	Rated Current (A)	Breaking Capacity	Power Loss *6			I ² t(A ² s)x10 ³	
				(W)	Connecting Bar		Fusing *2,7	Operating at V _{AC} *3,4,8
					in ²	mm ²		
QAS25-20 (S)	250 V _{AC} 300 V _{DC}	20	10kA at 250V _{AC} (ЯU)	2.0	0.019	12	0.03	0.82
QAS25-30 (S)		30		3.0	0.019	12	0.054	1.5
QAS25-50 (S)		50		5.0	0.037	24	0.17	2.9
QAS25-75 (S)		75		7.0	0.050	32	0.49	5.92
QAS25-100 (S)		100	100kA at 250 V _{AC} 10kA at 300 V _{DC} *1	10.0	0.070	45	0.87	9.8
QAL25-75 (S)		75		8.0	0.050	32	0.49	5.9
QAL25-100 (S)		100		10.0	0.070	45	0.87	9.8
QAL25-150 (S)		150		15.0	0.116	75	1.9	19.0
QAL25-200 (S)		200		20.0	0.248	160	3.5	35.0
QAL25-300 (S)		300		30.0	0.310	200	8.9	102.0
QAS60-20 (S)	600 V _{AC} 500 V _{DC}	20	100kA at 600 V _{AC}	3.0	0.019	12	0.030	0.6
QAS60-30 (S)		30		5.0	0.019	12	0.054	1.2
QAS60-50 (S)		50		10.0	0.037	24	0.17	2.8
QAS60-75 (S)		75		17.0	0.050	32	0.47	6.0
QAL60-100 (S)		100	10kA at 500 V _{DC} *1	20.0	0.050	32	0.87	14.0
QAL60-150 (S)		150		26.0	0.155	100	2.3	38.0
QAL60-200 (S)		200		32.0	0.248	160	4.4	84.0
QAL60-250 (S)		250		38.0	0.310	200	7.9	135.0
QAL60-300 (S)		300		43.0	0.310	200	14.0	175.0
QFS25-10 (S)		250 V _{AC} 400 V _{DC}		10	10kA at 250V _{AC} (cЯUus) (TÜV)	1.0	0.016	10
QFS25-20 (S)	20		2.1	0.022		14.4	0.035	0.17
QFS25-30 (S)	30		3.8	0.040		26	0.055	0.35
QFS25-50 (S)	50		5.9	0.070		45	0.18	0.85
QFS25-75 (S)	75		8.0	0.093	60	0.49	2.3	
QFS25-100 (S)	100		100kA at 250 V _{AC} 10kA at 400 V _{DC} (cЯUus) *1	11.6	0.124	80	0.88	4.0
QFL25-75 (S)	75			7.7	0.093	60	0.49	2.3
QFL25-100 (S)	100			10.6	0.124	80	0.88	4.0
QFL25-150 (S)	150			17.6	0.194	125	1.98	9.5
QFL25-200 (S)	200			22.5	0.310	200	3.51	17.0
QFL25-300 (S)	300	35.4		0.465	300	8.99	38.0	

*1. Time constant is 4ms max.

*2. Calculated value.

*3. Actual measured value at conventional current of 250VAC at 100kA (r.m.s.) and short-circuit power factor of 14%.

*4. Indicates actual measured value at conventional current of 600VAC at 100kA (r.m.s.) and short-circuit power factor of 7%.

*5. QAS / QAL / QFS / QFL - Specifications of the indicator fuse are the same.

*6. Max value at rated current.

*7. Radiation is not considered in this calculated value.

*8. Max value at conventional current of 250VAC at 100kA (r.m.s.) and short-circuit power factor of 16%.

(S) : Indicator fuse option available, place an S at the end of the PN. Example QAS60-300 becomes QAS60-300S



Outline drawings show fuse with indicator fuse specifications

EXTERNAL DIMENSIONS

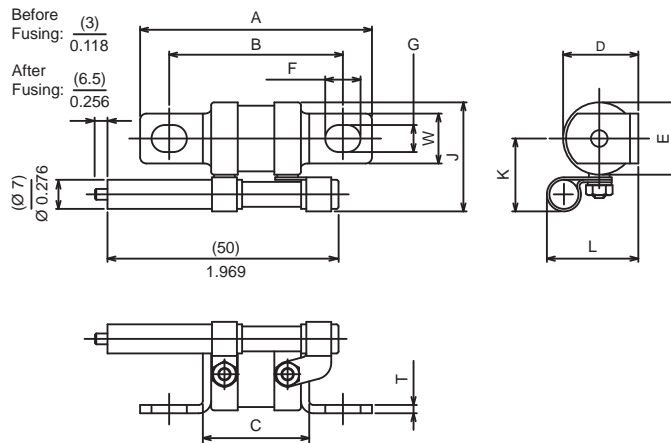
Model	External dimensions: in (mm)												Weight: oz (gram)	Mounting Hole, Bolt Size Limit
	A	B	C	D	E	F	G	T	W	J	K	L		
QFS25-10 (S)	2.205 (56)	1.654 (42)	1.024 (26)	0.728 (18.5)	0.689 (17.5)	0.335 (8.5)	0.256 (6.5)	0.079 (2)	0.472 (12)	1.024 (26)	0.689 (17.5)	0.866 (22)	1.058 (30)	1/4 - 20 (M6)
QAS25-20 (S)														
QFS25-20 (S)														
QAS25-30 (S)														
QFS25-30 (S)														
QAS25-50 (S)														
QFS25-50 (S)														
QAS25-75 (S)														
QFS25-75 (S)														
QAS25-100 (S)	3.150 (80)	2.283 (58)	1.142 (29)	1.220 (31)	1.063 (27)	0.433 (11)	0.354 (9)	0.118 (3)	0.787 (20)	1.378 (35)	0.846 (21.5)	1.181 (30)	3.527 (100)	5/16 - 18 (M9)
QAL25-75 (S)														
QFL25-75 (S)														
QAL25-100 (S)														
QFL25-100 (S)														
QAL25-150 (S)	3.346 (85)	2.362 (60)	1.142 (29)	1.358 (34.5)	1.220 (31)	0.512 (13)	0.433 (11)	0.118 (3)	0.984 (25)	1.535 (39)	0.925 (23.5)	1.240 (31.5)	4.762 (135)	7/16 - 14 (M11)
QFL25-200 (S)														
QAL25-300 (S)	3.346 (85)	2.362 (60)	1.142 (29)	1.594 (40.5)	1.457 (37)	0.512 (13)	0.433 (11)	0.118 (3)	1.181 (30)	1.771 (45)	1.043 (26.5)	1.358 (34.5)	6.526 (185)	7/16 - 14 (M11)
QFL25-300 (S)														
QAS60-20 (S)	2.756 (70)	2.205 (56)	1.575 (40)	0.728 (18.5)	0.689 (17.5)	0.335 (8.5)	0.256 (6.5)	0.079 (2)	0.472 (12)	1.024 (26)	0.689 (17.5)	0.866 (22)	1.270 (36)	1/4 - 20 (M6)
QAS60-30 (S)														
QAS60-50 (S)														
QAS60-75 (S)														
QAS60-100 (S)	3.661 (93)	2.795 (71)	1.654 (42)	1.240 (31.5)	1.063 (27)	0.433 (11)	0.354 (9)	0.118 (3)	0.787 (20)	1.378 (35)	0.846 (21.5)	1.181 (30)	4.056 (115)	5/16 - 18 (M9)
QAS60-150 (S)														
QAS60-200 (S)	3.819 (97)	2.835 (72)	1.614 (41)	1.358 (34.5)	1.220 (31)	0.512 (13)	0.433 (11)	0.118 (3)	0.984 (25)	1.535 (39)	0.925 (23.5)	1.240 (31.5)	5.291 (150)	7/16 - 14 (M11)
QAS60-250 (S)														
QAS60-300 (S)														
QAS60-200 (S)	3.898 (99)	2.913 (74)	1.693 (43)	1.594 (40.5)	1.497 (37)	0.512 (13)	0.433 (11)	0.118 (3)	1.181 (30)	1.771 (45)	1.043 (26.5)	1.358 (34.5)	7.760 (220)	7/16 - 14 (M11)
QAS60-250 (S)														
QAS60-300 (S)														



DECISION TABLES

1 First Decision		QAS25 - □ - □	3 Third Decision		
Model			Accessories		
QAS25	General Product (no approvals)	2 Second Decision	No entry	Fuse unit only	
QAL25			S	Equipped with fusing indicator fuse	
QAS60			S-M1	Equipped with fusing indicator fuse and microswitch with housing (silver contacts, solder-on terminals)***	
QAL60			S-M2	Equipped with fusing indicator fuse and microswitch with housing (gold contacts, quick-connect #110 terminals)	
QFS25			S-M3	Equipped with fusing indicator fuse and smaller microswitch with housing (silver contacts, solder-on terminals)***	
QFL25	 	Input a value from 10 to 300 Use reference table "Ratings & Specifications"	S-M4	Equipped with fusing indicator fuse and smaller microswitch with housing (gold contacts, solder-on terminals)***	
QAS25U				T	cRUUs, TÜV approved product, available only on QFS25U and QFL25U. No indicator fuse or microswitch options.
QAL25U					
QAS60U					
QAL60U					
QFS25U					
QFL25U					
QFS25U-□-T					
QFL25U-□-T					

Fuse



Fuse & Indicator Fuse with Microswitch



Fuse & Indicator Fuse



Fuse, Indicator Fuse with Microswitch & Fuse Holder

