

## 30 W Programmable CC Class 2 LED Driver with Enhanced Tri-Mode Dimming™ (TRIAC, ELV & 0-10 V)

Nominal Input Voltage	Max. Output Power	Efficiency	Max. Case Temperature	THD	Power Factor	Dimming Method	Dimming Range	Startup Time
120 & 277 Vac	30 W	up to 90% typical	90°C (measured at the hot spot)	< 20%	> 0.9	Programmable Forward-Phase, Reverse-Phase & 0 - 10 V	1 - 100% (% of Iout)	300 ms typical

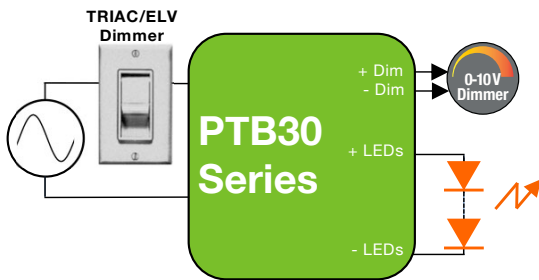

**Side Leads**  
L 70 \* W 40 \* H 29.5 mm  
(L 2.76 \* W 1.57 \* H 1.16 in.)

### FEATURES

- Class 2 power supply
- Lifetime: 50,000 hours @ Tc ≤ 75°C
- 90°C maximum case hot spot temperature
- IP20-rated case
- Surge protection:
  - IEC61000-4-5: 2 kV line to line/2 kV line to earth
  - 2.5 kV ring wave: ANSI/IEEE c62.41.1-2002 & c62.41.2-2002 category A
- Complies with ENERGY STAR®, DLC (DesignLight Consortium®) and CA Title 24 technical requirements
- Mounting clips for multiple mounting methods

### PROGRAMMING

- Audio jack programming
- Current: 100% to 60% in each voltage range
- 0-10 V dimming profiles: Linear, Non-linear, Logarithmic
- Programmable conduction angles with turn-on & turn-off for TRIAC & ELV
- Data log read: SKU, S/N, lot code, hours of operation, FW rev., power cycles

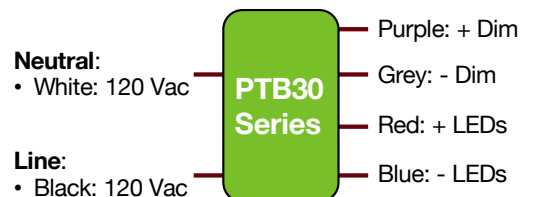

**Wiring Diagram**

### APPLICATIONS

- Commercial & residential lighting
- Architectural lighting
- Indoor Lighting



## 30 W Programmable CC Class 2 LED Driver with Enhanced Tri-Mode Dimming™ (TRIAC, ELV & 0-10 V)

### 1 - ORDERING INFORMATION

Part Number	Nominal Input Voltage (Vac)	Max Output Power (W)	I <sub>out</sub> (mA)	Default Programmed Current (mA)	V <sub>out</sub> Min. (Vdc)	V <sub>out</sub> Nom. (Vdc)	V <sub>out</sub> Max. (Vdc)	Open Loop (No Load) Voltage (Vdc)
<b>120 &amp; 277 VAC NOMINAL INPUT VOLTAGE</b>								
PTB15W-0350-42	120 & 277	14.7	210 to 350	250	28	37.8	42	50
PTB30W-0500-42	120 & 277	21.0	300 to 500	350	28	37.8	42	50
PTB30W-0700-42	120 & 277	29.4	420 to 700	500	28	37.8	42	50

**Notes:**

- By default, each PTB series driver is shipped with 2 metal mounting clips. Additional mounting clips can be ordered separately using the part number PTB-CLIPS-100 or PTB-CLIPS-1K
- For additional options of output current and output voltage, contact your sales representative or send an email to: [SaveEnergy@erp-power.com](mailto:SaveEnergy@erp-power.com)
- Please order the programming cable using the part number PROG-JACK-USB.

**Programming Cable**

Part number: PROG-JACK-USB



## 30 W Programmable CC Class 2 LED Driver with Enhanced Tri-Mode Dimming™ (TRIAC, ELV & 0-10 V)

### 2 - INPUT SPECIFICATION (@25° C ambient temperature)

	Units	Minimum	Typical	Maximum	Notes
<b>Input Voltage Range (Vin)</b>	Vac	90	120, 277	305	<ul style="list-style-type: none"> <li>The rated output current for each model is achieved at <math>V_{in} \geq 108</math> Vac &amp; at <math>V_{in} \geq 249</math> Vac.</li> <li>At nominal load</li> </ul>
<b>Input Frequency Range</b>	Hz	47	50/60	63	
<b>Input Current (Iin)</b>	A			0.32 A @ 120 Vac 0.15 A @ 277 Vac	
<b>Power Factor (PF)</b>		0.9	> 0.9		<ul style="list-style-type: none"> <li>At nominal input voltage and with nominal LED voltage</li> <li>From 100% to 60% of rated power</li> </ul>
<b>Inrush Current</b>	A	Meets NEMA-410 requirements			<ul style="list-style-type: none"> <li>At any point on the sine wave and 25°C</li> <li>Active limiting inrush current is available as an option. Please contact your ERP representative or send an email to SaveEnergy@erp-power.com.</li> </ul>
<b>Leakage Current</b>	mA			0.3 mA @ 120 Vac 0.7 mA @ 277 Vac	Measured per IEC60950-1
<b>Input Harmonics</b>	Complies with IEC61000-3-2 for Class C equipment				
<b>Total Harmonics Distortion (THD)</b>				20%	<ul style="list-style-type: none"> <li>At nominal input voltage and nominal LED voltage</li> <li>From 100% to 60% of rated power</li> <li>Complies with DLC (Design Light Consortium) technical requirements</li> </ul>
<b>Efficiency</b>	%	-	up to 90%	-	Measured with nominal input voltage, a full sinusoidal wave form and without dimmer attached.
<b>Isolation</b>	The AC input to the main DC output and 0-10 V circuit is isolated. UL8750 supplement SF compliant.				

### 3 - MAIN OUTPUT SPECIFICATION (@25° C ambient temperature)

	Units	Minimum	Typical	Maximum	Notes
<b>Output Voltage (Vout)</b>	Vdc				See ordering information for details
<b>Output Current (Iout)</b>	mA				<ul style="list-style-type: none"> <li>See ordering information for details</li> <li>The rated output current for each model is achieved at <math>V_{in} \geq 108</math> Vac &amp; at <math>V_{in} \geq 249</math> Vac.</li> </ul>
<b>Output Current Regulation</b>	%	-5	±2.5	5	<ul style="list-style-type: none"> <li>At nominal AC line voltage</li> <li>Includes load and current set point variations</li> </ul>
<b>Output Current Overshoot</b>	%	-	-	10	The driver does not operate outside of the regulation requirements for more than 500 ms during power on with nominal LED load and without dimmer.
<b>Ripple Current</b>	≤ 20% of rated output current for each model				<ul style="list-style-type: none"> <li>Measured at nominal LED voltage and nominal input voltage without dimming</li> <li>Calculated in accordance with the IES Lighting Handbook, 9th edition</li> <li>Meets IEEE 1789-2015 recommended practices for flicker</li> </ul>
<b>Dimming Range (% of Iout)</b>	%	1		100	<ul style="list-style-type: none"> <li>The dimming range is dependent on each specific dimmer. It may not be able to achieve 1% dimming with some dimmers.</li> <li>Dimming performance is optimal when the driver is operated at its nominal output voltage matching the LED nominal Vf (forward voltage). Dimming performance may vary when the driver is operated near its minimum output voltage.</li> </ul>
<b>Start-up Time</b>	ms		300	500	<ul style="list-style-type: none"> <li>Without any dimmer attached, and at nominal input voltages and nominal load</li> <li>Measured from application of AC line voltage to 100% light output</li> <li>Complies with ENERGY STAR® luminaire specification and CA Title 24</li> </ul>
<b>Isolation</b>	The main DC output is certified and tested per UL8750 Class 2 or LED Class 2. UL8750 supplement SF compliant.				

## 30 W Programmable CC Class 2 LED Driver with Enhanced Tri-Mode Dimming™ (TRIAC, ELV & 0-10 V)

### 4 - 0-10 V DIMMING CONTROL (@25° C ambient temperature)

In the PTB30 series, several 0-10 V dimming profiles can be selected, such as a logarithmic profile, a non-linear profile with 1% minimum dimming, and a non-linear profile with 10% minimum dimming.

By default, the non-linear profile with 1% minimum dimming (shown in figure 1) is pre-loaded in the PTB30 series.

	Units	Minimum	Typical	Maximum	Notes
<b>+Dim Signal, -Dim Signal</b>	The PTB30 series operate only with 0-10 V dimmers that sink current. The method to dim the output current of the driver is done via the +Dim/-Dim Signal pins. The +Dim/-Dim signal pins can be used to adjust the output setting via a standard commercial wall dimmer, an external control voltage source (0 to 10 Vdc), or a variable resistor when using the recommended number of LEDs. The dimming input permits 1% to 100% dimming.				
<b>Dimming Profile (see figure 1)</b>	100% of output current between 10 V and 8.2 V, Linear between 8.2 V and 1.5 V, 1% of output current below 1.5 V.				
<b>Dimming Range</b>	%	1		100	As a percent of the output current
<b>High Level Voltage - A</b>	V		8.2	8.5	
<b>Low Level Voltage - B</b>	V	0.5	1.5		
<b>Current Supplied by the +Dim Signal Pin</b>	mA			1	
<b>Output Current Tolerance While Being Dimmed</b>	%			±8	The tolerance of the output current while being dimmed is ≤ ±8% until down to 1.5V.
<b>Isolation</b>	The 0-10 V circuit is isolated from both the AC input and the main DC output and meets Class II reinforced/double insulation power supply.				

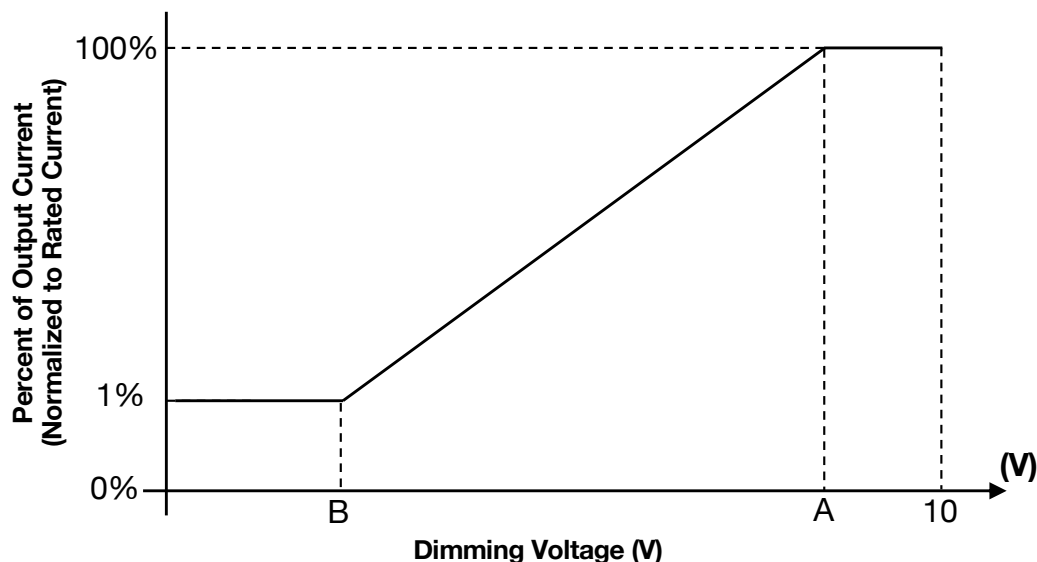

**Figure 1**

## 30 W Programmable CC Class 2 LED Driver with Enhanced Tri-Mode Dimming™ (TRIAC, ELV & 0-10 V)

### 5 - ENVIRONMENTAL CONDITIONS

	Units	Minimum	Typical	Maximum	Notes
<b>Operating Ambient Temperature (Ta)</b>	°C	-10		50	PTB30W-0700-42 & PTB30W-0500-42 are not recommended for IC (insulated contact) rated fixtures. ERP recommends the PSS series if designing an IC rated fixture
<b>Maximum Case Temperature (Tc)</b>	°C			+90	Case temperature measured at the hot spot •tc (see label in page 15)
<b>Storage Temperature</b>	°C	-40		+85	
<b>Humidity</b>	%	5	-	95	Non-condensing
<b>Cooling</b>	Convection cooled				
<b>Acoustic Noise</b>	dBA			24	Measured at a distance of 1 foot
<b>Mechanical Shock Protection</b>	per EN60068-2-27				
<b>Vibration Protection</b>	per EN60068-2-6 & EN60068-2-64				
<b>MTBF</b>	> 200,000 hours when operated at nominal input and output conditions, and at Tc ≤ 75°C				
<b>Lifetime</b>	50,000 hours at Tc ≤ 75°C maximum case hot spot temperature (see hot spot •tc on label in page 15)				

### 6 - EMC COMPLIANCE AND SAFETY APPROVALS

EMC Compliance		
<b>Conducted and Radiated EMI</b>	FCC CFR Title 47 Part 15 Class B at 120 Vac and Class A at 277 Vac	
<b>Harmonic Current Emissions</b>	IEC61000-3-2 For Class C equipment	
<b>Voltage Fluctuations &amp; Flicker</b>	IEC61000-3-3	
<b>Immunity Compliance</b>	<b>ESD (Electrostatic Discharge)</b>	IEC61000-4-2 6 kV contact discharge, 8 kV air discharge, level 3
	<b>RF Electromagnetic Field Susceptibility</b>	IEC61000-4-3 3 V/m, 80 - 1000 MHz, 80% modulated at a distance of 3 meters
	<b>Electrical Fast Transient</b>	IEC61000-4-4 ± 2 kV on AC power port for 1 minute, ± 1 kV on signal/control lines
	<b>Surge</b>	IEC61000-4-5 ± 2 kV line to line (differential mode) / ± 2 kV line to common mode ground (tested to secondary ground) on AC power port, ± 0.5 kV for outdoor cables ANSI/IEEE c62.41.1-2002 & c62.41.2-2002 category A, 2.5 kV ring wave
	<b>Conducted RF Disturbances</b>	IEC61000-4-6 3V, 0.15-80 MHz, 80% modulated
	<b>Voltage Dips</b>	IEC61000-4-11 >95% dip, 0.5 period; 30% dip, 25 periods; 95% reduction, 250 periods
Safety Agency Approvals		
<b>UL</b>	UL8750 Class 2	
<b>cUL</b>	CAN/CSA C22.2 No. 250.13-14 LED equipment for lighting applications	

Safety					
	Units	Minimum	Typical	Maximum	Notes
<b>Hi Pot (High Potential) or Dielectric voltage-withstand</b>	Vdc	4400			<ul style="list-style-type: none"> <li>Insulation between the input (AC line and Neutral) and the output</li> <li>Tested at the RMS voltage equivalent of 3100 Vac</li> <li>Double insulation </li> </ul>

## 30 W Programmable CC Class 2 LED Driver with Enhanced Tri-Mode Dimming™ (TRIAC, ELV & 0-10 V)

### ■ 7 - PROTECTION FEATURES

#### **Input Over Current Protection**

The PTB30 series incorporates a primary AC line fuse for input over current protection to prevent damage to the LED driver and meet product safety requirements as outlined in Section 6.

#### **Short Circuit and Over Current Protection**

The PTB30 series is protected against short-circuit such that a short from any output to return shall not result in a fire hazard or shock hazard. The driver shall hiccup as a result of a short circuit or over current fault. Removal of the fault will return the driver to within normal operation. The driver shall recover, with no damage, from a short across the output for an indefinite period of time.

#### **Internal Over temperature Protection**

The PTB30 series is equipped with internal temperature sensor on the primary power train. Failure to stay within the convection power rating will result in the power supply reducing the available current (fold back) below the programmed amount. The main output current will be restored to the programmed value when the temperature of the built-in temperature sensor cools adequately.

#### **Output Open Load Protection**

When the LED load is removed, the output voltage of the PTB30 series is typically limited to 1.3 times the maximum output voltage of each model.

### ■ 8 - OUTPUT POWER DE-RATING AT ELEVATED TEMPERATURES

The PTB30 series can be operated with cooling air temperatures above 50°C ambient by linearly de-rating the total maximum output power (or current) by 2.5%/°C typical from 50°C to 70°C.

## 30 W Programmable CC Class 2 LED Driver with Enhanced Tri-Mode Dimming™ (TRIAC, ELV & 0-10 V)

### 9 - PHASE-CUT DIMMING

Dimming of the driver is possible with standard TRIAC-based incandescent dimmers that chop the AC voltage as shown in Figure 2, or with ELV dimmers. During the rapid rise time of the AC voltage when the dimmer turns on, the driver does not generate any voltage or current oscillations, and inrush current is controlled. During the on-time of the AC input, the driver regulates the output current based upon the conduction angle. The RMS value of the driver output current is proportional to the on-time of the AC input voltage. When operating with an incandescent dimmer, the RMS output current varies depending upon the conduction angle and RMS value of the applied AC input voltage.

Forward-phase (TRIAC) and reverse-phase (ELV) dimming work only at 120 Vac.

The PTB30 series offers Tri-Mode Dimming™ compatibility with both phase-cut (reverse-phase and forward-phase) and 0-10V dimmers. Phase-cut dimming always has priority over 0-10 V dimming.

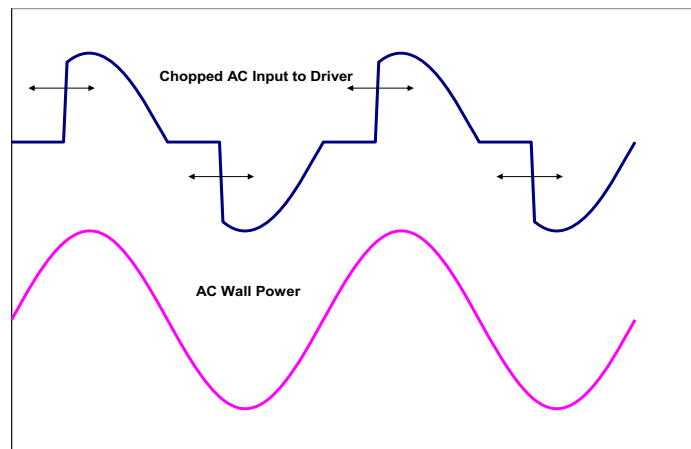

**Figure 2**

### 10 - COMPATIBLE PHASE-CUT DIMMERS

120Vac Dimmers					
Mfg.	Model	Mfg.	Model	Mfg.	Model
Lutron	LGCL-153PL	Lutron	DVRP-253P	Leviton	VPE06
Lutron	RRD-6CL	Lutron	NTELV-600P	Leviton	DW1KD-1BZ
Lutron	DVELV-303P	Lutron	MAELV-600	Cooper	SAL06P-W-K
Lutron	MACL-153M	Lutron	SCL-153P	Cooper	DAL06P
Lutron	RRD-10ND	Leviton	DSL06-1LZ	Cooper	TAL06P1-C1
Lutron	PD-6WCL	Leviton	IPE04		
Lutron	SELV-300P	Leviton	IPL06		
Lutron	DVCL-153P	Leviton	6674		

Dimming compatibility charts are available for each model in the PTB30 series on the ERP website: <https://www.erp-power.com/>.

## 30 W Programmable CC Class 2 LED Driver with Enhanced Tri-Mode Dimming™ (TRIAC, ELV & 0-10 V)

### 11 - 0-10 V DIMMING

The PTB30 series operate only with 0-10 V dimmers that sink current. They are not designed to operate with 0-10 V control systems that source current, as used in theatrical/entertainment systems. Developed in the 1980's, the 0-10 V sinking current control method is adopted by the International Electrotechnical Commission (IEC) as part of its IEC Standard 60929 Annex E.

The method to dim the output current of the driver is done via the +Dim/-Dim Signal pins. The +Dim/-Dim Signal pins respond to a 0 to 10 V signal, delivering 1% to 100% of the output current based on rated current for each model. A pull-up resistor is included internal to the driver. When the +Dim wire (purple) is short circuited to the -Dim wire (grey) or to the -LED wire (blue), the output current turns off.

If the +Dim input is > 10 V or open circuited, the output current is programmed to 100% of the rated current. When not used, the -Dim wire (grey) and to the +Dim wire (purple) can be individually capped or cut off. In this configuration, no dimming is possible and the driver delivers 100% of its rated output current.

The maximum source current (flowing from the driver to the 0-10 V dimmer) supplied by the +Dim Signal pin is  $\leq 1$  mA. The tolerance of the output current while being dimmed shall be  $\pm 8\%$  typical until down to 1.5 V.

In the PTB30 series, several 0-10 V dimming profiles can be selected, such as a logarithmic profile, a non-linear profile with 1% minimum dimming, and a non-linear profile with 10% minimum.

By default, the non-linear profile with 1% minimum dimming (show in figure 3) is pre-loaded in the PTB30 series. In this non-linear 0-10 V dimming profile, 10 V to 8.2 V=100% of the output current, linear between 8.2 V and 1.5 V, <1.5 V=1%.

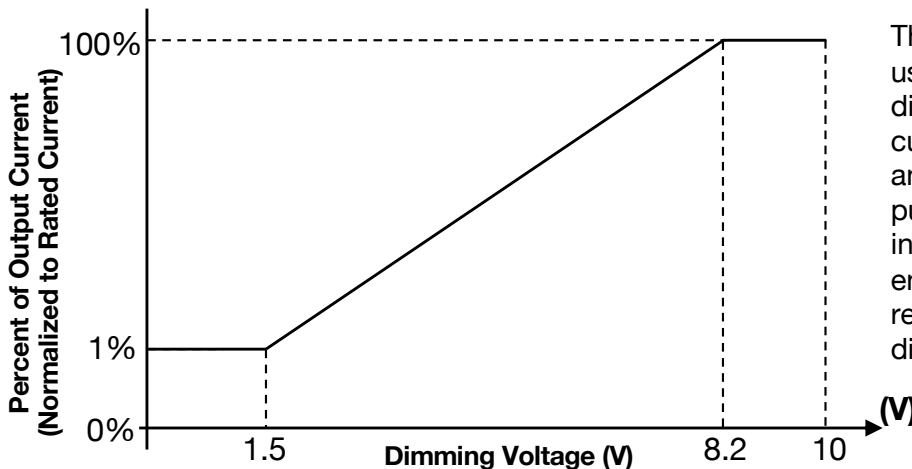

Figure 3

The non-linear curve is recommended when using standard in wall 0-10 V logarithmic dimmers to avoid having insufficient source current available to pull the dimmer up to 10 V and to account for the inability of the dimmer to pull below approximately 0.9 V. In these type of installations, the modified transfer function will ensure 100% light output and dimming to 1%, regardless of the number of drivers on the 0-10 V dimming line.

### 12 - COMPATIBLE 0-10 V DIMMERS

Mfg.	Model	Mfg.	Model	Mfg.	Model
Lutron	NFTV	Lutron	DVTV	Lutron	DVSTV
Leviton	IP710-LFZ	Lightolier	SR1200ZTUNV	Cooper	SF10P-W
Leviton	IP710-DL				

## 30 W Programmable CC Class 2 LED Driver with Enhanced Tri-Mode Dimming™ (TRIAC, ELV & 0-10 V)

### ■ 13 - PROGRAMMING

The PTB30 series can be programmed by inserting the audio jack plug into the driver and by plugging the USB other end of the cable into a computer. **The driver does not need to be powered on during the programming process.**

When ordering the PTB30 series, please make sure you order a programming cable. The part number for the programming cable is “PROG-JACK-USB”.

Programming is done by using the ERP GUI (Graphical User Interface), which enables the user to adjust output current from 100% to 60%.

Furthermore, when programming the driver with a computer using the programming cable, you can access the driver’s internal data log and read the following information: SKU, serial number, manufacturing lot code, hours of operation, firmware revision, and AC power cycles.

For more information, please refer to the GUI user’s manual at:  
<https://www.erp-power.com/our-products/programming-software/>



Figure 4

## 30 W Programmable CC Class 2 LED Driver with Enhanced Tri-Mode Dimming™ (TRIAC, ELV & 0-10 V)

### 14 - PREDICTED LIFETIME VERSUS CASE AND AMBIENT TEMPERATURE

Lifetime is defined by the measurement of the temperatures of all the electrolytic capacitors whose failure would affect light output under the nominal LED load and worst case AC line voltage. The graphs in figures 5 and 6 are determined by the electrolytic capacitor with the shortest lifetime, among all electrolytic capacitors. It represents a worst case scenario in which the LED driver is powered 24 hours/day, 7 days/week. The lifetime of an electrolytic capacitor is measured when any of the following changes in performance are observed:

- 1) Capacitance changes more than 20% of initial value
- 2) Dissipation Factor ( $\tan \delta$ ): 150% or less of initial specified value
- 3) Equivalent Series Resistance (ESR): 150% or less of initial specified value
- 4) Leakage current: less of initial specified value

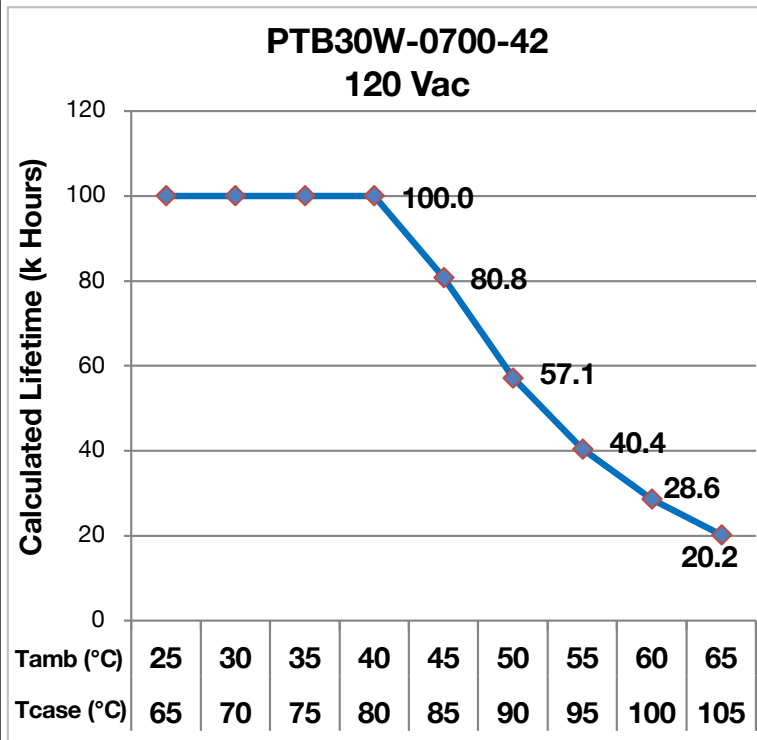

Figure 5

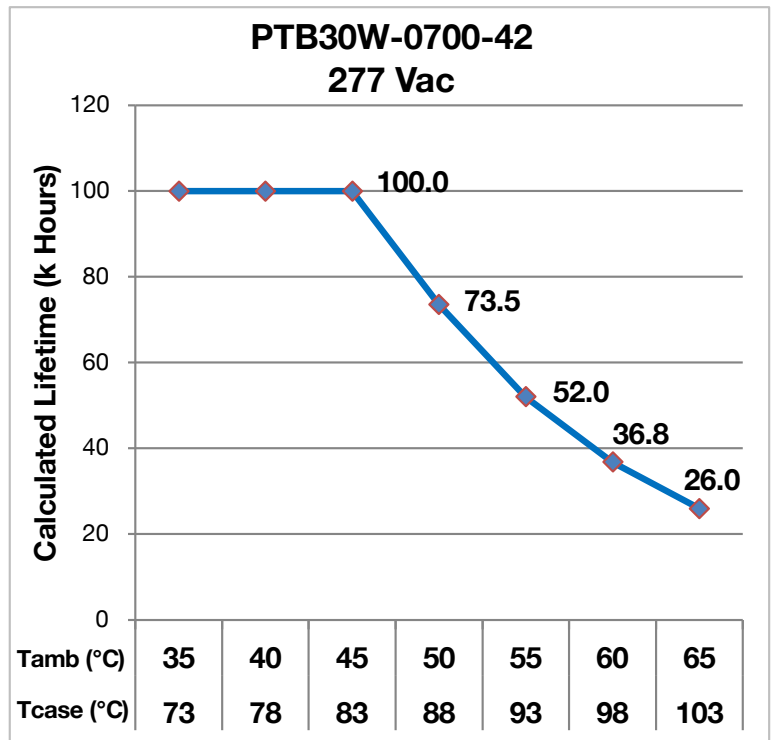

Figure 6

- Notes:
- The PTB30W-0700-42 and PTB30W-0500-42 are not recommended for IC (Insulated Contact) rated fixtures. For IC rated applications at the 30 W power level, ERP recommends the use of the PSS series.
  - The ambient temperature  $T_{ambient}$  and the differential between  $T_{ambient}$  and  $T_{case}$  mentioned in the above graphs are relevant only as long as both the driver and the light fixture are exposed to the same ambient room temperature. If the LED driver is housed in an enclosure or covered by insulation material, then the ambient room temperature is no longer valid. In this situation, please refer only to the case temperature  $T_{case}$ .
  - It should be noted the graph "Lifetime vs. Ambient Temperature" may have an error induced in the final application if the mounting has restricted convection flow around the case. For applications where this is evident, the actual case temperature measured at the Tc point in the application should be used for reliability calculations.

## 30 W Programmable CC Class 2 LED Driver with Enhanced Tri-Mode Dimming™ (TRIAC, ELV & 0-10 V)

### 15 – EFFICIENCY VERSUS LOAD

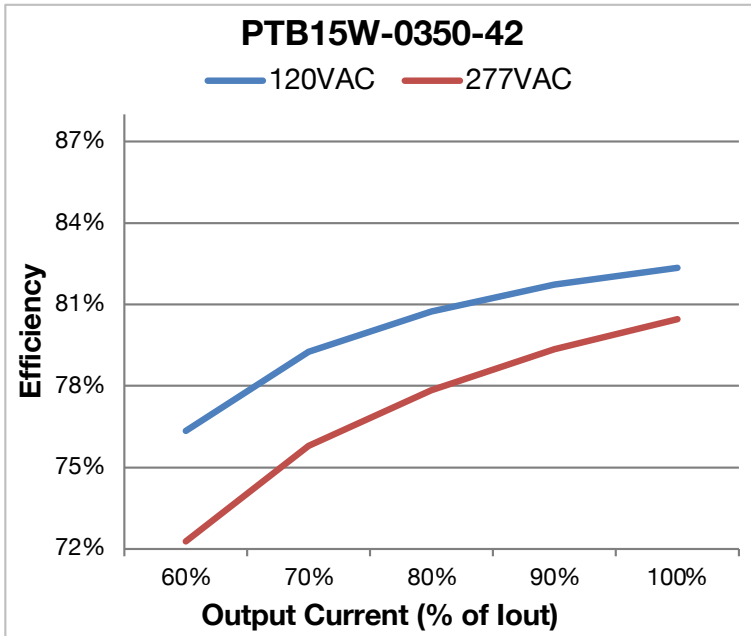

Figure 7

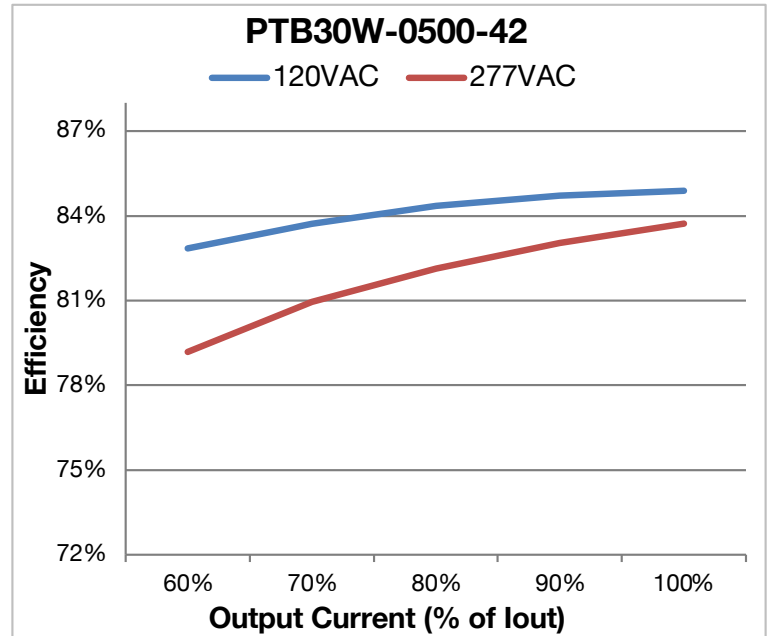

Figure 8

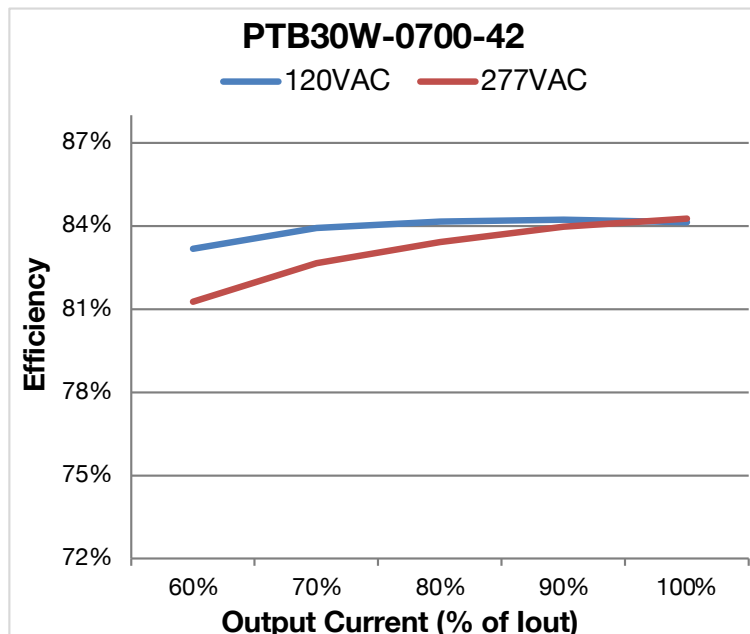

Figure 9

## 30 W Programmable CC Class 2 LED Driver with Enhanced Tri-Mode Dimming™ (TRIAC, ELV & 0-10 V)

16 – POWER FACTOR VERSUS LOAD

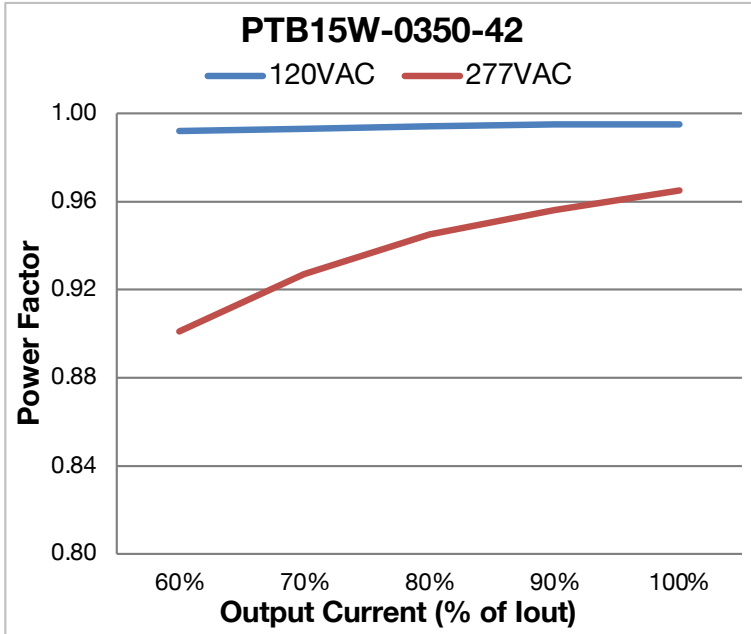

Figure 10

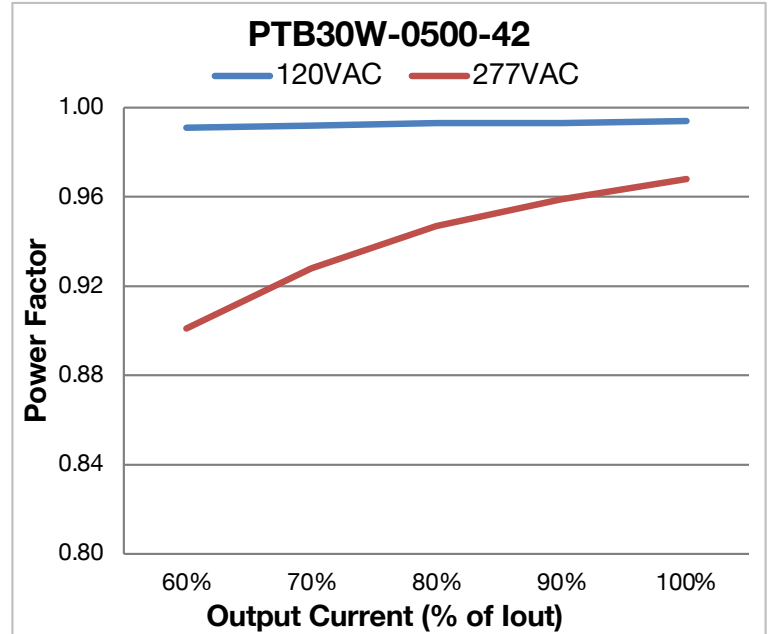

Figure 11

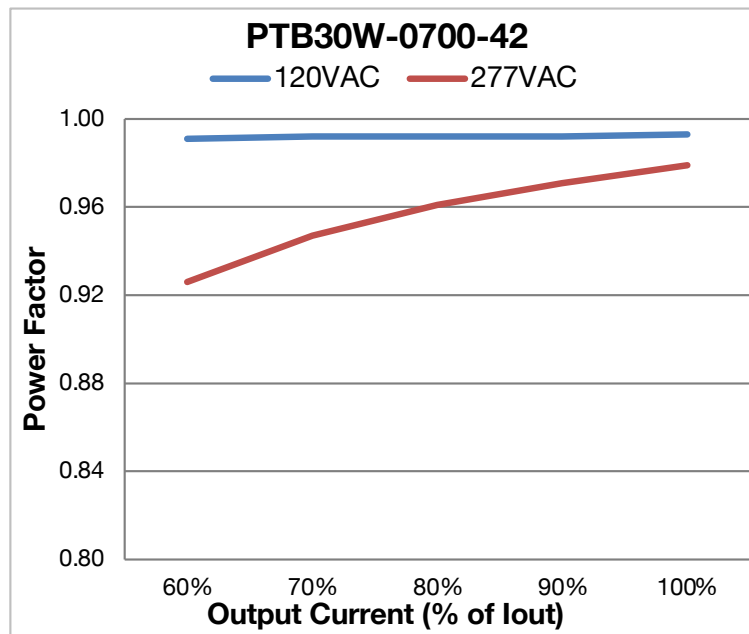

Figure 12

## 30 W Programmable CC Class 2 LED Driver with Enhanced Tri-Mode Dimming™ (TRIAC, ELV & 0-10 V)

17 - THD VERSUS LOAD

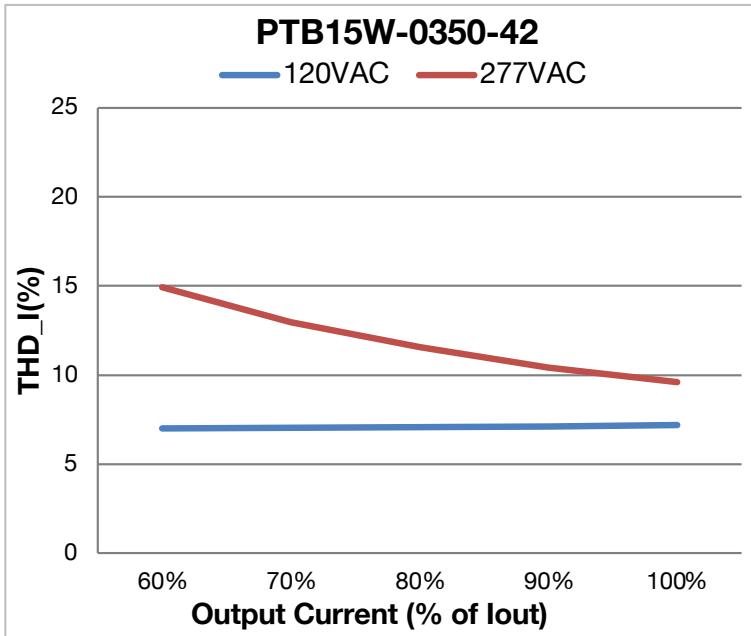

Figure 13

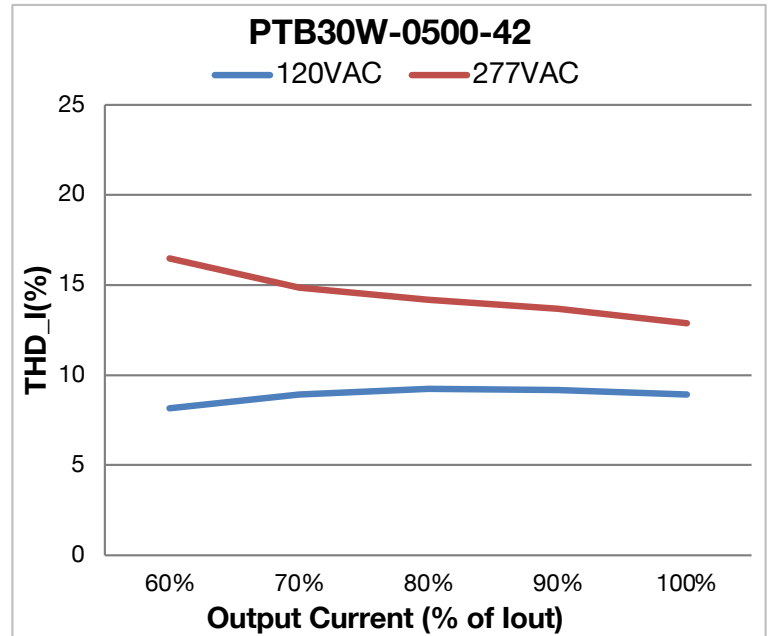

Figure 14

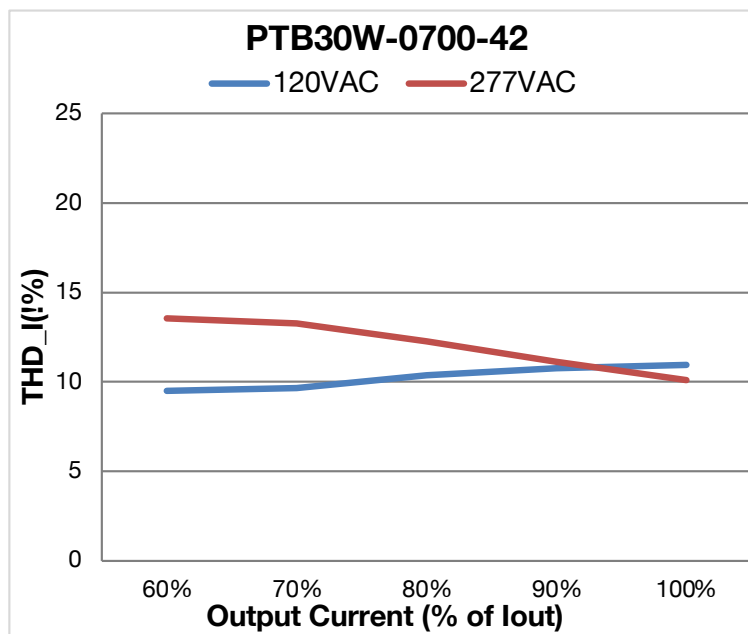

Figure 15

## 30 W Programmable CC Class 2 LED Driver with Enhanced Tri-Mode Dimming™ (TRIAC, ELV & 0-10 V)

### 14 - MECHANICAL DETAILS

- **Packaging:** Plastic case
- **I/O Connections:**
  - **Models with flying leads:** 18 AWG on all leads, 22 AWG on 0-10V dimming wires, 157 mm (6.18 in) long, 105°C rated, stranded, stripped by approximately 9.5 mm, and tinned. All the wires, on both input and output, have a 300 V insulation rating.
- **Ingress Protection:** IP20 rated
- **Mounting Instructions:** The PTB30 driver case must be secured on a flat surface through the two mounting clips, shown here below in the case outline drawings.

### 15 - OUTLINE DRAWINGS (MODELS WITH FLYING LEADS)

**Dimensions:** L 70 \* W 40 \* H 29.5 mm (L 2.76 \* W 1.57 \* H 1.16 in.)

**Volume:** 82.6 cm<sup>3</sup> (5.02 in<sup>3</sup>)

**Weight:** 119 g (4.2 oz)

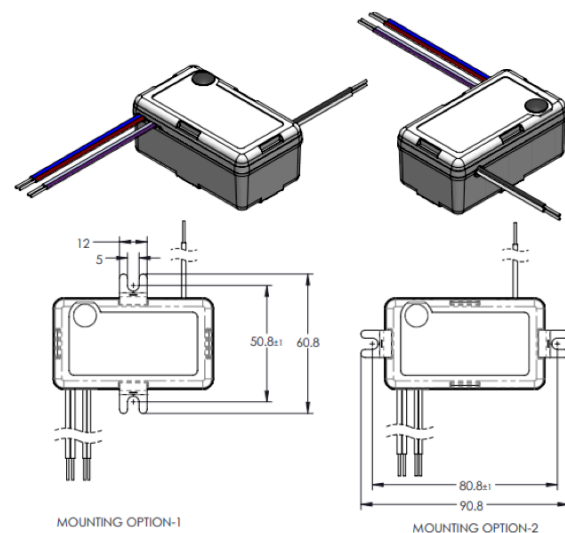
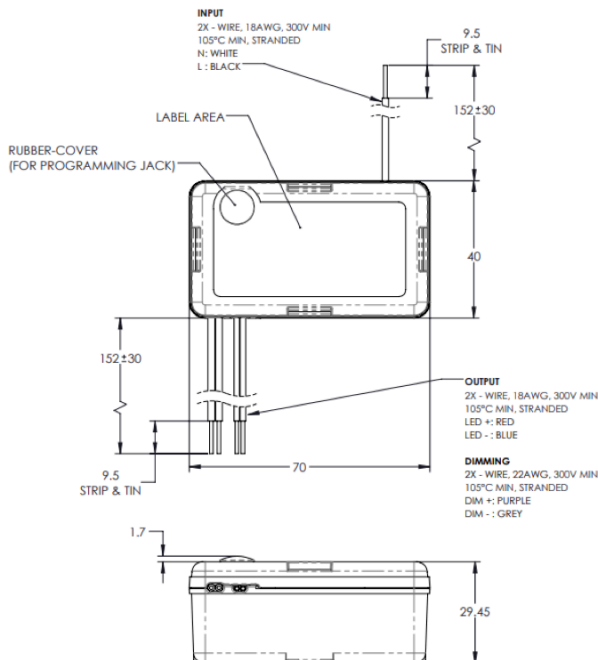

**Note:**

- By default, each PTB series driver is shipped with 2 metal mounting clips. Additional mounting clips can be ordered separately using the part number PTB-CLIPS-100 or PTB-CLIPS-1K

All dimensions are in mm

**Figure 16**

## 30 W Programmable CC Class 2 LED Driver with Enhanced Tri-Mode Dimming™ (TRIAC, ELV & 0-10 V)

### 16 - LABELING

The PTB15W-0350-42 is used in figure 17 as an example to illustrate a typical label.

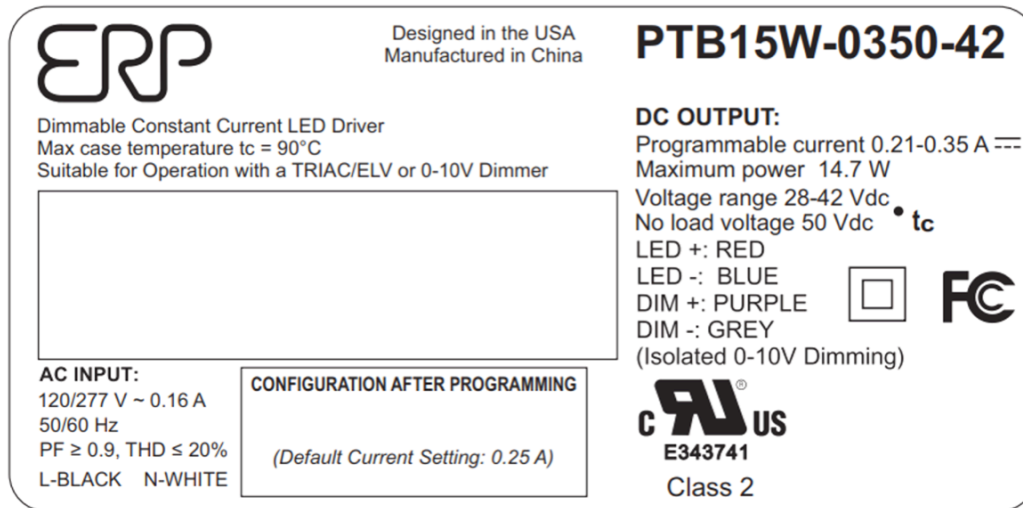

Figure 17

#### USA Headquarters

Tel: +1-805-517-1300  
Fax: +1-805-517-1411  
893 Patriot Drive, Suite E,  
Moorpark, CA 93021, USA

#### CHINA Operations

Tel: +86-756-6266298  
Fax: +86-756-6266299  
No. 8 Pingdong Road 2  
Zhuhai, Guangdong, China 519060

ERP Power, LLC (ERP) reserves the right to make changes without further notice to any products herein. ERP makes no warranty, representation or guarantee regarding the suitability of its products for any particular purpose, nor does ERP assume any liability arising out of the application or use of any product or circuit, and specifically disclaims any and all liability, including without limitation special, consequential or incidental damages. "Typical" parameters which may be provided in ERP data sheets and/or specifications can and do vary in different applications and actual performance may vary over time. All operating parameters, including "Typicals" must be validated for each customer application by customer's technical experts. ERP does not convey any license under its patent rights nor the rights of others. ERP products are not designed, intended, or authorized for use as components in systems intended for surgical implant into the body, or other applications intended to support or sustain life, or for any other application in which the failure of the ERP product could create a situation where personal injury or death may occur. Should Buyer purchase or use ERP products for any such unintended or unauthorized application, Buyer shall indemnify and hold ERP and its officers, employees, subsidiaries, affiliates, and distributors harmless against all claims, costs, damages, and expenses, and reasonable attorney fees arising out of, directly or indirectly, any claim of personal injury or death associated with such unintended or unauthorized use, even if such claim alleges that ERP was negligent regarding the design or manufacture of the part. ERP is an Equal Opportunity/Affirmative Action Employer. This literature is subject to all applicable copyright laws and is not for resale in any manner.



# PTB30/15 Series

**PTB30** 30 W  
**PTB15** 15 W

**30 W Programmable CC Class 2 LED Driver with  
Enhanced Tri-Mode Dimming™ (TRIAC, ELV & 0-10 V)**

## Revision History

Date	Comments
16NOV2020	Initial Release