

Three Phase Rectifier Bridges

PSD 35

$I_{dAVM} = 38 \text{ A}$
 $V_{RRM} = 800-1800 \text{ V}$

Preliminary Data Sheet

| V_{RSM} V | V_{RRM} V | Type |
|----------------|----------------|-----------|
| 800 | 800 | PSD 35/08 |
| 1200 | 1200 | PSD 35/12 |
| 1400 | 1400 | PSD 35/14 |
| 1600 | 1600 | PSD 35/16 |
| 1800 | 1800 | PSD 35/18 |

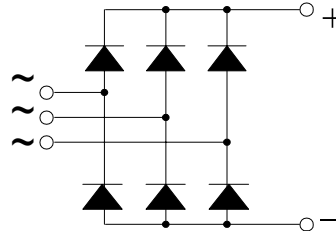

| Symbol | Test Conditions | Maximum Ratings |
|---------------|---|--------------------------------|
| I_{dAVM} | $T_C = 85^\circ\text{C}$, module | 38 A |
| I_{FSM} | $T_{VJ} = 45^\circ\text{C}$ $V_R = 0$ $t = 10 \text{ ms}$ (50 Hz), sine | 400 A |
| | $t = 8.3 \text{ ms}$ (60 Hz), sine | 440 A |
| | $T_{VJ} = T_{VJM}$ $V_R = 0$ $t = 10 \text{ ms}$ (50 Hz), sine | 360 A |
| | $t = 8.3 \text{ ms}$ (60 Hz), sine | 400 A |
| $\int i^2 dt$ | $T_{VJ} = 45^\circ\text{C}$ $V_R = 0$ $t = 10 \text{ ms}$ (50 Hz), sine | 800 $\text{A}^2 \text{ s}$ |
| | $t = 8.3 \text{ ms}$ (60 Hz), sine | 810 $\text{A}^2 \text{ s}$ |
| | $T_{VJ} = T_{VJM}$ $V_R = 0$ $t = 10 \text{ ms}$ (50 Hz), sine | 650 $\text{A}^2 \text{ s}$ |
| | $t = 8.3 \text{ ms}$ (60 Hz), sine | 670 $\text{A}^2 \text{ s}$ |
| T_{VJ} | | -40 ... + 150 $^\circ\text{C}$ |
| T_{VJM} | | 150 $^\circ\text{C}$ |
| T_{stg} | | -40 ... + 150 $^\circ\text{C}$ |
| V_{ISOL} | 50/60 HZ, RMS $t = 1 \text{ min}$ | 2500 V ~ |
| | $I_{ISOL} \leq 1 \text{ mA}$ $t = 1 \text{ s}$ | 3000 V ~ |
| M_d | Mounting torque (M4) | 1.5 Nm |
| | Terminal connection torque (M4) | 1.5 Nm |
| Weight | typ. | 110 g |

Features

- Package with screw terminals
- Isolation voltage 3000 V~
- Planar glasspassivated chips
- Blocking voltage up to 1800 V
- Low forward voltage drop
- UL registered E 148688

Applications

- Supplies for DC power equipment
- Input rectifiers for PWM inverter
- Battery DC power supplies
- Field supply for DC motors

Advantages

- Easy to mount with two screws
- Space and weight savings
- Improved temperature and power cycling capability

Package, style and outline

Dimensions in mm (1mm = 0.0394")

| Symbol | Test Conditions | Characteristic Value |
|------------|--|-----------------------|
| I_R | $V_R = V_{RRM}$ $T_{VJ} = 25^\circ\text{C}$ | $\leq 0.3 \text{ mA}$ |
| | $V_R = V_{RRM}$ $T_{VJ} = T_{VJM}$ | $\leq 5.0 \text{ mA}$ |
| V_F | $I_F = 150 \text{ A}$ $T_{VJ} = 25^\circ\text{C}$ | $\leq 2.2 \text{ V}$ |
| V_{TO} | For power-loss calculations only | 0.85 V |
| r_T | $T_{VJ} = T_{VJM}$ | 12 $\text{m}\Omega$ |
| R_{thJC} | per diode; DC current | 4.2 K/W |
| | per module | 0.7 K/W |
| R_{thJK} | per diode; DC current | 4.8 K/W |
| | per module | 0.8 K/W |
| d_S | Creeping distance on surface | 6.2 mm |
| d_A | Creeping distance in air | 6.2 mm |
| a | Max. allowable acceleration | 50 m/s^2 |

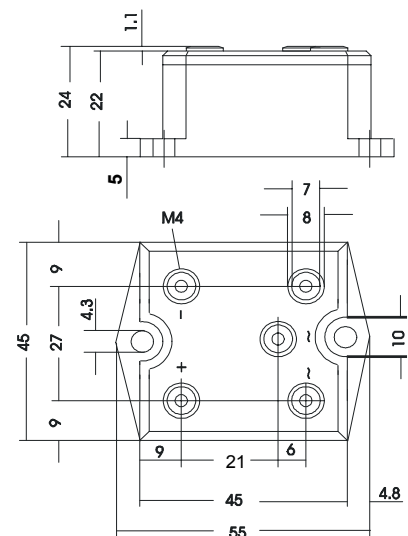

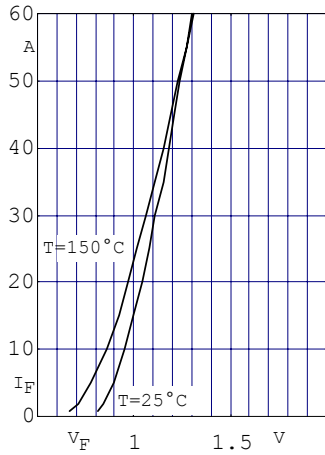

Fig. 1 Forward current versus voltage drop per diode

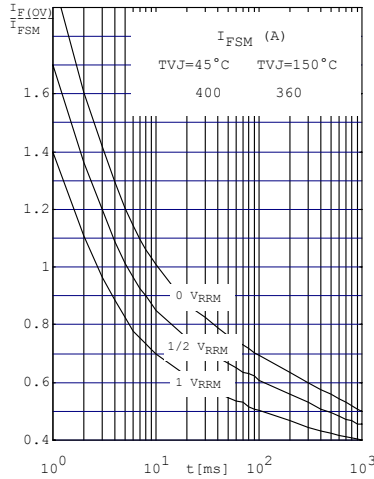

Fig. 2 Surge overload current per diode I_{FSM} : Crest value. t : duration

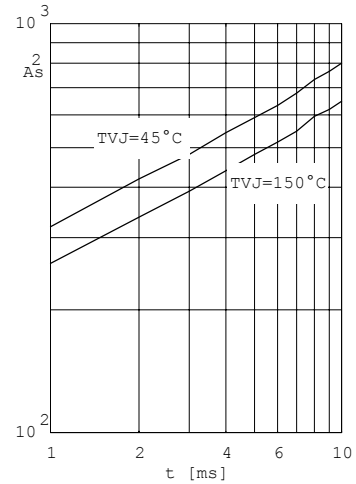

Fig. 3 $\int i^2 dt$ versus time (1-10ms) per diode (or thyristor)

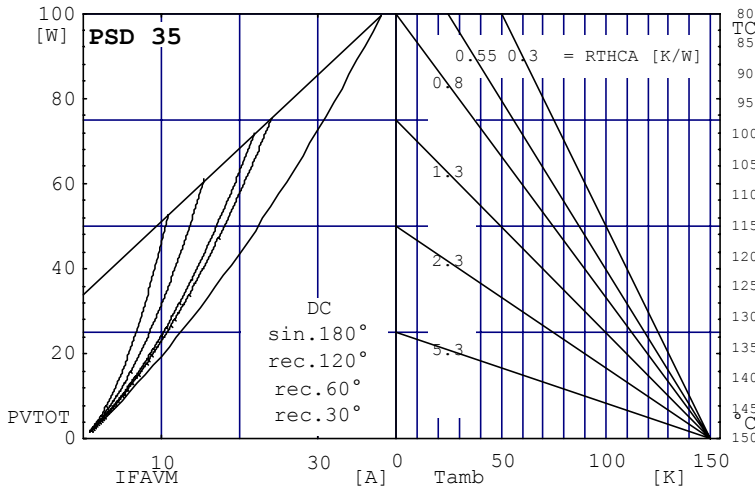

Fig. 4 Power dissipation versus direct output current and ambient temperature

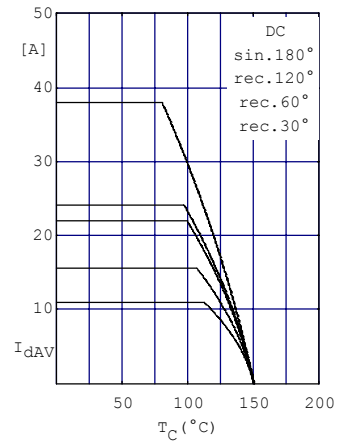

Fig. 5 Maximum forward current at case temperature

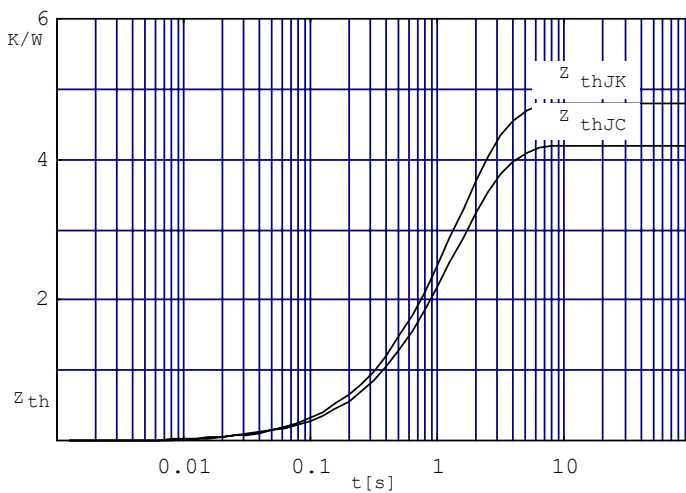

Fig. 6 Transient thermal impedance per diode (or thyristor), calculated