

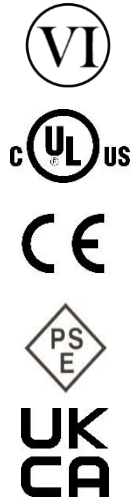

10W F-Series Interchangeable Plug Adapter with DC Cord



Features

- Folding Blades
- 15mm Thick with Blades Folded
- Constant Current for Battery Charging
- DOE Level VI Efficiency Compliance
- Ecodesign/ErP Lot 7 (EU) 2019/1782 Compliance
- Interchangeable Clips (sold separately)
- 2.1mm x 5.5mm Barrel or USB Micro-B Connector options

Applications

- Tablets
- Personal Electronics
- Networking Equipment
- Peripherals



PSA10F Specifications¹

Model		PSA10F-050-R	PSA10F-050(P)-R ²
Output	DC Output Voltage	5.0V	
	Max Current	2.0A	
	Output Power	10.0W	
	Regulation	± 5%	
	Ripple & Noise P-P(max) ³	200mV	
Input	AC Input Voltage Range	90 to 264VAC	
	AC Input Frequency	47 to 63Hz	
	Input Current	0.3A RMS max @120VAC, 0.15A RMS max @240VAC	
	Inrush Current	60A at 240VAC	
	No Load Power Consumption at 115VAC Input	0.055W	
	No Load Power Consumption at 230VAC Input	0.077W	
	115VAC Average Efficiency ⁴	80.07%	
	230VAC Average Efficiency ⁴	79.33%	
	230VAC 10% Load Efficiency ⁴	71.92%	
	Leakage Current	100uA max at 240VAC	
Protection	Over-Voltage	6.3VDC max. Auto-restart	
	Short Circuit	Must withstand continuous short circuit	
Environmental	Operating Temperature	0°C to +40°C	
	Non-Operating Temperature	-40° to +85°C	
	Operating Humidity	10 to +90%	
Safety Approvals and EMC	Dielectric Withstand (HI-POT)	Primary to Secondary: 3000VAC for 1min, 10mA	
	Insulation Resistance	DC 500V, >7M ohm	
	Standards	cULus 62368-1, IEC 62368-1, PSE	
	EMI Emissions	FCC Part 15 Class B, CAN ICES-003(B)/NMB-003(B), EN 55032/CISPR 32 Class B Conducted and Radiated	
	Harmonic Current Emissions	IEC 61000-3-2	
	Voltage Fluctuations & Flicker	IEC 61000-3-3	
	Immunity	EN 55024/CISPR 24: IEC 61000-4-2 (+/- 8kV air, +/- 4kV contact), IEC 61000-4-3, IEC 61000-4-4, IEC 61000-4-5 (+/- 1kV), IEC 61000-4-6, IEC 61000-4-8, IEC 61000-4-11	
Mechanical	Dimensions (L x W x H)	60.0mm (2.36in) x 47.0mm (1.85in) x 15.0mm (0.59in)	
	Weight	67g	
	AC Input	US fixed blade folding prong	
	DC Output Connector	USB Micro-B	2.1mm x 5.5mm x 10.0mm Barrel Center Positive Polarity
Notes	<ol style="list-style-type: none"> The specifications defined are at ambient temperature of 25°C, unless otherwise specified. Special order item. Minimum order quantity applies. 20MHz bandwidth frequency oscilloscope, add a 0.1µF multilayer Cap. and Low ESR Electrolytic Cap. (10µF) at output connector terminals (nominal line voltage, full load). Efficiency is measured after 30 minutes burn-in. 		



PSA10F-050 Outline Drawing

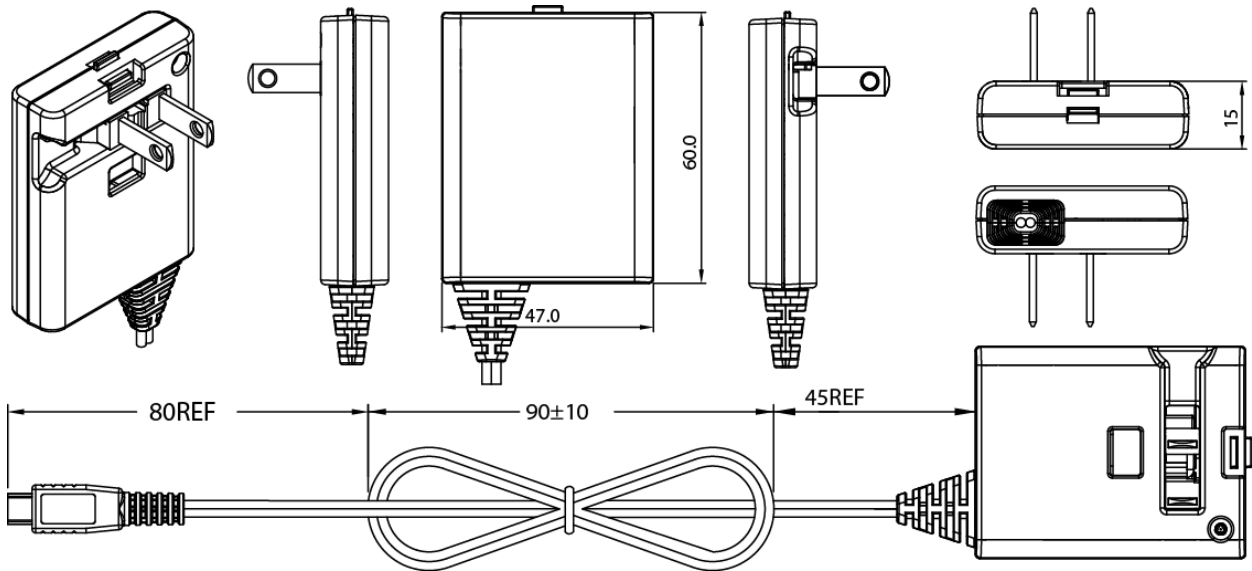



PSA10F-050(P) Outline Drawing

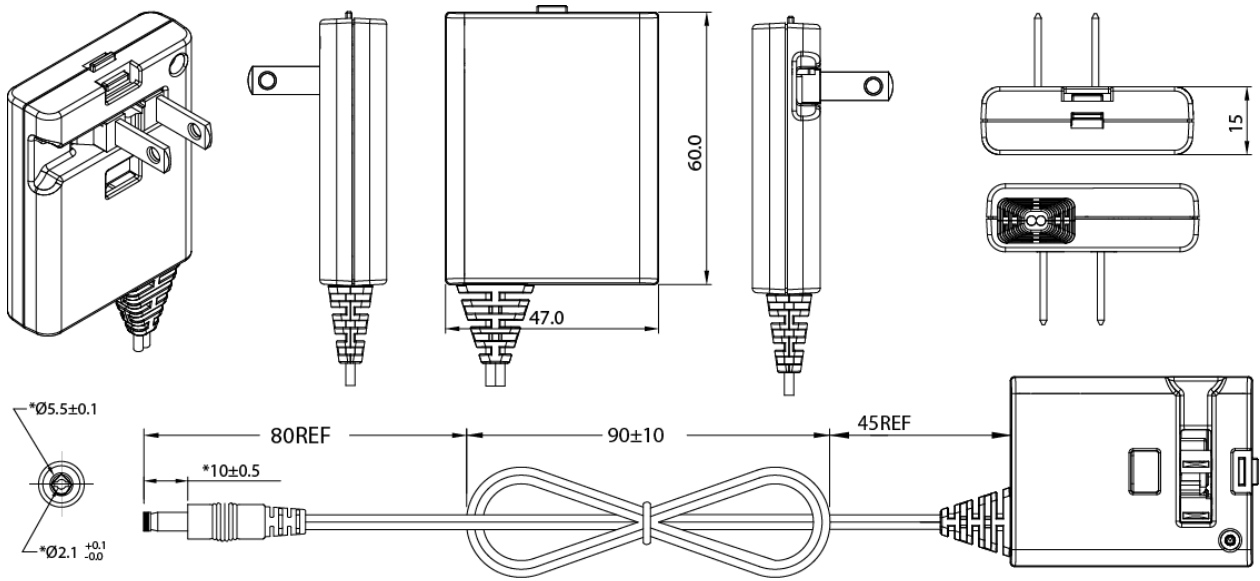







**Supplier's Declaration of Conformity
47 CFR § 2.1077 Compliance Information**



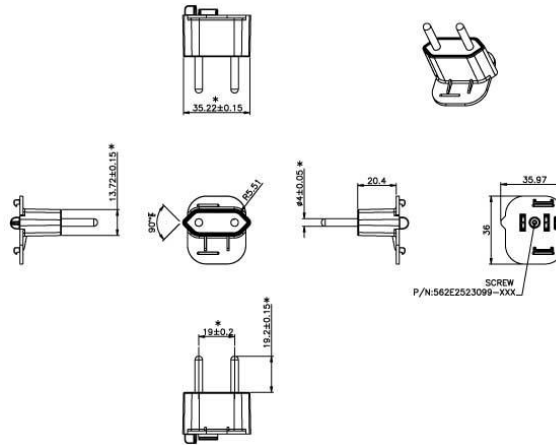

Phihong USA Corporation
47800 Fremont Boulevard
Fremont, CA 94538
Telephone: (510) 445-0100
www.phihong.com

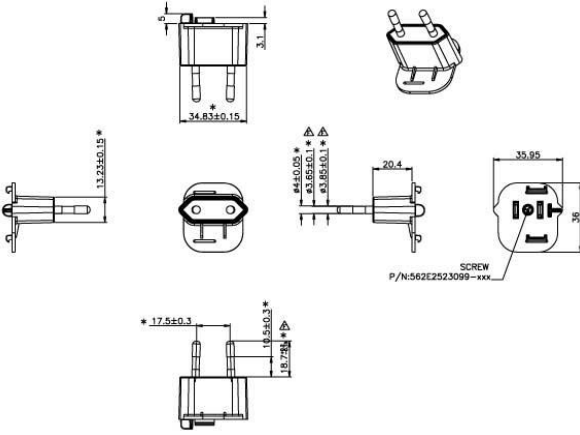
This device complies with/The devices in this product series comply with part 15 of the FCC Rules. Operation is subject to the following two conditions: (1) This device may not cause harmful interference, and (2) this device must accept any interference received, including interference that may cause undesired operation.

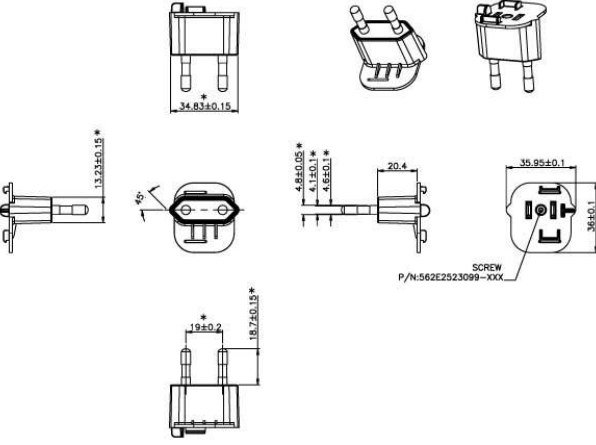

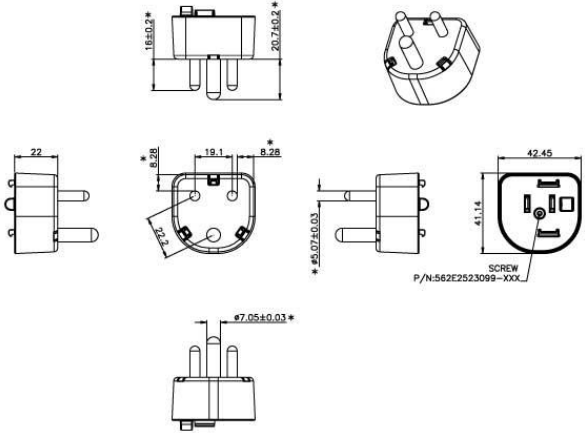
AC Input Clips - Sold Separately

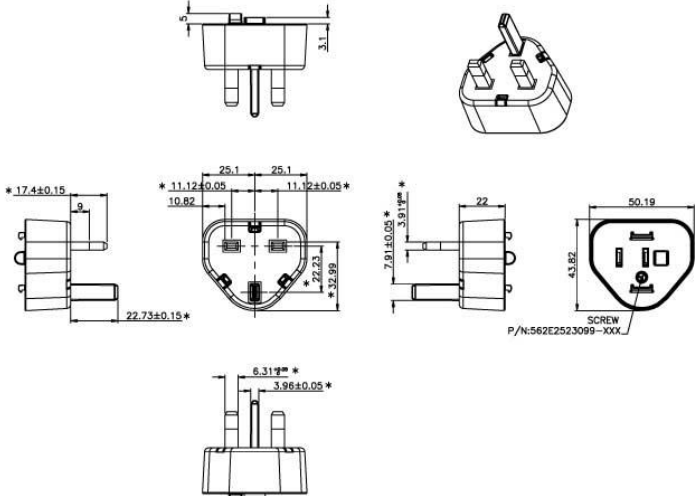
FPB-H – BRAZIL CLIP	Dimension Drawing Unit: mm
	
	
	

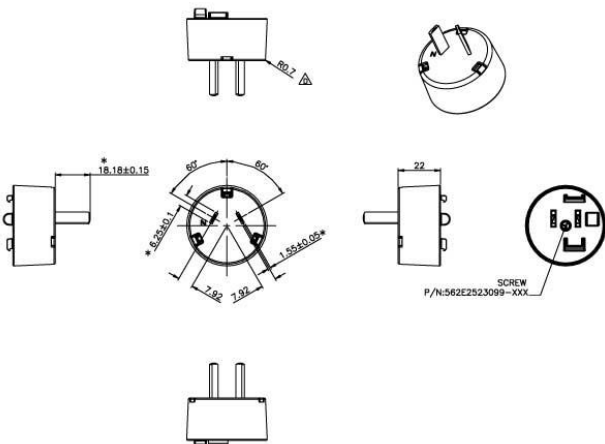
<p>FPI-H – INDIA CLIP</p> 	<p>Dimension Drawing Unit: mm</p> 
<p>FPK-H – UK CLIP</p> 	<p>Dimension Drawing Unit: mm</p> 
<p>FPN-H – ARGENTINA CLIP</p> 	<p>Dimension Drawing Unit: mm</p> 

FPBAG1-H

EU & UK CLIP

