

SERIES: PQD6-D | **DESCRIPTION:** DC-DC CONVERTER

FEATURES

- up to 6 W isolated output
- smaller package
- 4:1 input range (9~36 V, 18~75 V)
- single/dual regulated output
- 1,500 Vdc isolation
- continuous short circuit, over current protection
- six-sided shielded case
- temperature range (-40~85°C)
- high efficiency at light load
- efficiency up to 88%



| MODEL | input voltage | | output voltage (Vdc) | output current | | output power max (W) | ripple and noise ¹ max (mVp-p) | efficiency typ (%) |
|----------------|---------------|-------------|-------------------------|----------------|----------|-------------------------|----------------------------------------------|-----------------------|
| | typ (Vdc) | range (Vdc) | | min (mA) | max (mA) | | | |
| PQD6-Q24-S3-D | 24 | 9~36 | 3.3 | 75 | 1500 | 5 | 75 | 79 |
| PQD6-Q24-S5-D | 24 | 9~36 | 5 | 60 | 1200 | 6 | 75 | 83 |
| PQD6-Q24-S12-D | 24 | 9~36 | 12 | 25 | 500 | 6 | 75 | 87 |
| PQD6-Q24-S15-D | 24 | 9~36 | 15 | 20 | 400 | 6 | 75 | 88 |
| PQD6-Q24-S24-D | 24 | 9~36 | 24 | 12 | 250 | 6 | 75 | 88 |
| PQD6-Q24-D5-D | 24 | 9~36 | ±5 | ±30 | ±600 | 6 | 75 | 83 |
| PQD6-Q24-D12-D | 24 | 9~36 | ±12 | ±12 | ±250 | 6 | 75 | 87 |
| PQD6-Q24-D15-D | 24 | 9~36 | ±15 | ±10 | ±200 | 6 | 75 | 88 |
| PQD6-Q48-S3-D | 48 | 18~75 | 3.3 | 75 | 1500 | 5 | 75 | 79 |
| PQD6-Q48-S5-D | 48 | 18~75 | 5 | 60 | 1200 | 6 | 75 | 83 |
| PQD6-Q48-S12-D | 48 | 18~75 | 12 | 25 | 500 | 6 | 75 | 87 |
| PQD6-Q48-S15-D | 48 | 18~75 | 15 | 20 | 400 | 6 | 75 | 88 |
| PQD6-Q48-S24-D | 48 | 18~75 | 24 | 12 | 250 | 6 | 75 | 88 |
| PQD6-Q48-D5-D | 48 | 18~75 | ±5 | ±30 | ±600 | 6 | 75 | 83 |
| PQD6-Q48-D12-D | 48 | 18~75 | ±12 | ±12 | ±250 | 6 | 75 | 87 |
| PQD6-Q48-D15-D | 48 | 18~75 | ±15 | ±10 | ±200 | 6 | 75 | 88 |

Notes: 1. ripple and noise are measured at 20 MHz BW by "parallel cable" method

PART NUMBER KEY

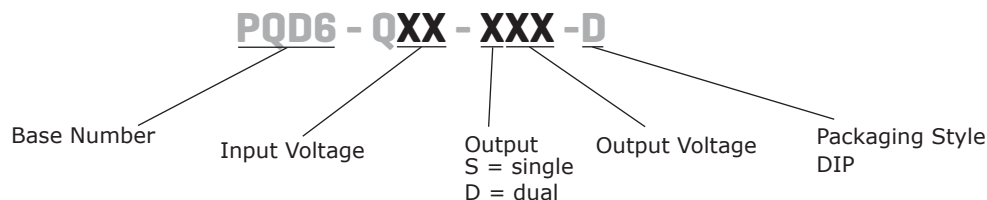

INPUT

| parameter | conditions/description | min | typ | max | units |
|---------------------------|-------------------------|------|------|-----|-------|
| operating input voltage | 24 V input models | 9 | 24 | 36 | Vdc |
| | 48 V input models | 18 | 48 | 75 | Vdc |
| start-up voltage | 24 V input models | | | 9 | Vdc |
| | 48 V input models | | | 18 | Vdc |
| surge voltage | for maximum of 1 second | | | | |
| | 24 V input models | -0.7 | | 50 | Vdc |
| | 48 V input models | -0.7 | | 100 | Vdc |
| filter | pi filter | | | | |
| no-load power consumption | | | 0.15 | 0.3 | W |

OUTPUT

| parameter | conditions/description | min | typ | max | units |
|------------------------------|------------------------------------------------------|-----|------|-------|-------|
| line regulation | full load, input voltage from low to high | | ±0.2 | ±0.5 | % |
| load regulation | 5% to 100% load | | ±0.5 | ±1 | % |
| cross regulation | dual output | | | | |
| | main output 50% load, secondary output 10%-100% load | | | ±5 | % |
| voltage accuracy | | | ±1 | ±2 | % |
| voltage balance ¹ | dual output, balanced loads | | ±0.5 | ±1.5 | % |
| switching frequency | | | 300 | | KHz |
| transient recovery time | 25% load step change | | 300 | 500 | µs |
| transient response deviation | 25% load step change | | ±3 | ±5 | % |
| temperature coefficient | 100% load | | | ±0.03 | %/°C |

Note: 1. For dual output models, unbalanced load can not exceed ±5%. If ±5% is exceeded, it may not meet all specifications.

PROTECTIONS

| parameter | conditions/description | min | typ | max | units |
|--------------------------|--------------------------------|-----|-----|-----|-------|
| short circuit protection | continuous, automatic recovery | | | | |
| over current protection | | 120 | | 180 | %Io |
| over voltage protection | | 110 | | 140 | %Vo |

SAFETY AND COMPLIANCE

| parameter | conditions/description | min | typ | max | units |
|------------------------------|-------------------------------------------------------------------------------|-----------|-------|-----|-------|
| isolation voltage | for 1 minute at 1 mA max. | 1,500 | | | Vdc |
| isolation resistance | at 500 Vdc | 1,000 | | | MΩ |
| isolation capacitance | input to output, 100 KHz/0.1 V | | 1,000 | | pF |
| safety approvals | CE | | | | |
| conducted emissions | CISPR22/EN55022, class A, class B (external circuit required, see Figure 1-b) | | | | |
| radiated emissions | CISPR22/EN55022, class A, class B (external circuit required, see Figure 1-b) | | | | |
| ESD | IEC/EN61000-4-2, class B, contact ± 4kV | | | | |
| radiated immunity | IEC/EN61000-4-3, class A, 10V/m | | | | |
| EFT/burst | IEC/EN61000-4-4, class B, ± 2kV (external circuit required, see Figure 1-a) | | | | |
| surge | IEC/EN61000-4-5, class B, ± 2kV (external circuit required, see Figure 1-a) | | | | |
| conducted immunity | IEC/EN61000-4-6, class A, 3 Vr.m.s | | | | |
| voltage dips & interruptions | IEC/EN61000-4-29, class B, 0%-70% | | | | |
| MTBF | as per MIL-HDBK-217F @ 25°C | 1,000,000 | | | hours |
| RoHS compliant | 2011/65/EU | | | | |

ENVIRONMENTAL

| parameter | conditions/description | min | typ | max | units |
|-----------------------|---------------------------------------------|-----|-----|-----|-------|
| operating temperature | see derating curve | -40 | | 85 | °C |
| storage temperature | | -55 | | 125 | °C |
| storage humidity | non-condensing | 5 | | 95 | % |
| case temperature | at full load, Ta=71°C | | | 105 | °C |
| vibration | 10~55 Hz for 30 min. along X, Y, and Z axis | | 10 | | G |

SOLDERABILITY

| parameter | conditions/description | min | typ | max | units |
|----------------|---------------------------------|-----|-----|-----|-------|
| hand soldering | 1.5 mm from case for 10 seconds | | | 300 | °C |
| wave soldering | see wave soldering profile | | | 260 | °C |

MECHANICAL

| parameter | conditions/description | min | typ | max | units |
|---------------|--------------------------------------------------|-----|-----|-----|-------|
| dimensions | 25.40 x 25.40 x 11.70 (1.00 x 1.00 x 0.461 inch) | | | | mm |
| case material | aluminum alloy | | | | |
| weight | | | 14 | | g |

MECHANICAL DRAWING

units: mm[inch]
 tolerance: $\pm 0.25[\pm 0.010]$
 pin diameter tolerance: $\pm 0.10[\pm 0.004]$
 pin height tolerance: $\pm 0.50[\pm 0.020]$

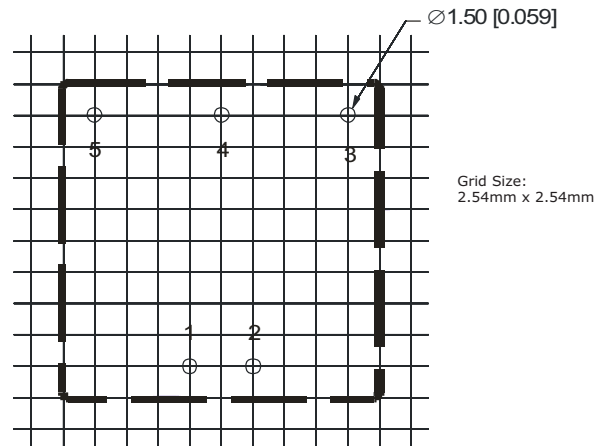
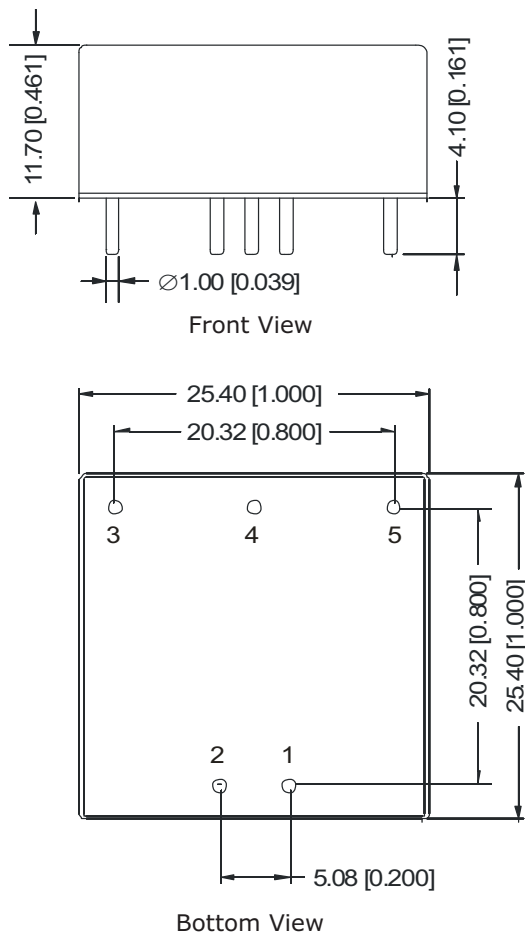

PCB Layout
Top View

| PIN CONNECTIONS | | |
|-----------------|---------------|-------------|
| PIN | Single Output | Dual Output |
| 1 | GND | GND |
| 2 | Vin | Vin |
| 3 | +Vo | +Vo |
| 4 | NO PIN | 0V |
| 5 | 0V | -Vo |

DERATING CURVES

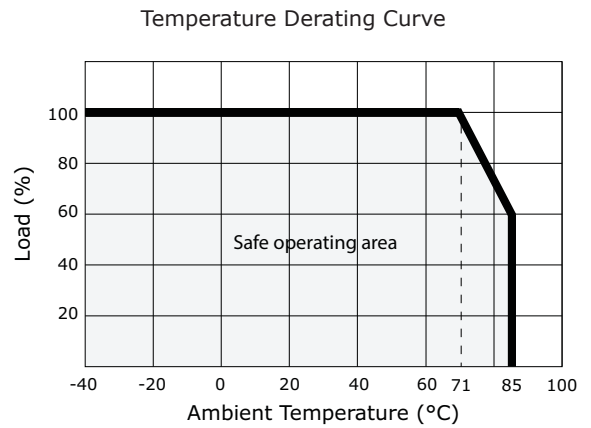
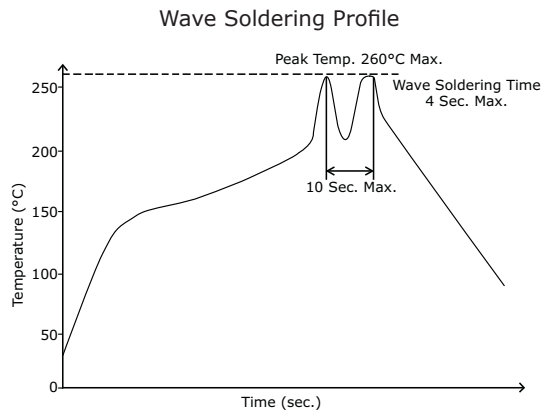

EMC RECOMMENDED CIRCUIT

Figure 1

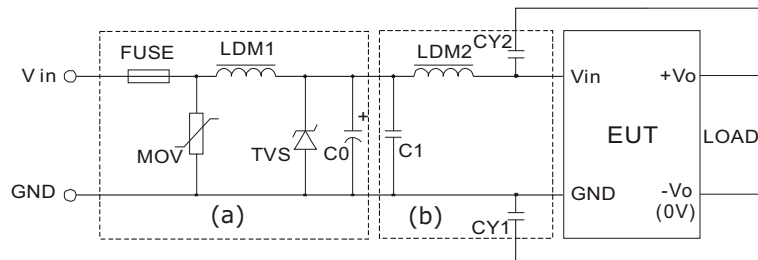

Table 1

| Recommended external circuit components | | |
|-----------------------------------------|---------------------------------------------|------------|
| Vin (Vdc) | 24 | 48 |
| FUSE | choose according to practical input current | |
| MOV | 10D560K | 10D101K |
| LDM1 | 56μH | 56μH |
| TVS | SMCJ48A | SMCJ90A |
| C0 | 120μF/50V | 120μF/100V |
| C1 | 225K/50V | 225K/100V |
| LDM2 | 4.7μH | 4.7μH |
| CY1 | 102K/2000V | 102K/2000V |
| CY2 | 102K/2000V | 102K/2000V |

TEST CONFIGURATION

Figure 2

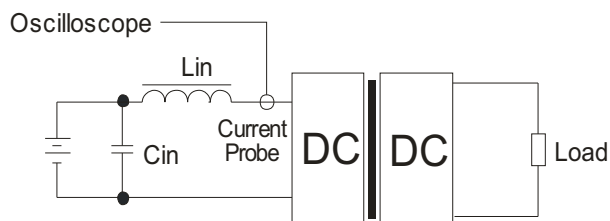

Table 2

| External components | |
|---------------------|------------------------------|
| Lin | 4.7μH |
| Cin | 220μF, ESR < 1.0Ω at 100 KHz |

Note: Input reflected-ripple current is measured with an inductor Lin and Capacitor Cin to simulate source impedance.

APPLICATION NOTES

1. Recommended circuit

This series has been tested according to the following recommended testing circuit before leaving the factory. This series should be tested under load (see Figure 3). If you want to further decrease the input/output ripple, you can increase the capacitance accordingly or choose capacitors with low ESR (see Table 3). However, the capacitance of the output filter capacitor must be appropriate. If the capacitance is too high, a startup problem might arise. For every channel of the output, to ensure safe and reliable operation, the maximum capacitance must be less than the maximum capacitive load (see Table 4).

Figure 3

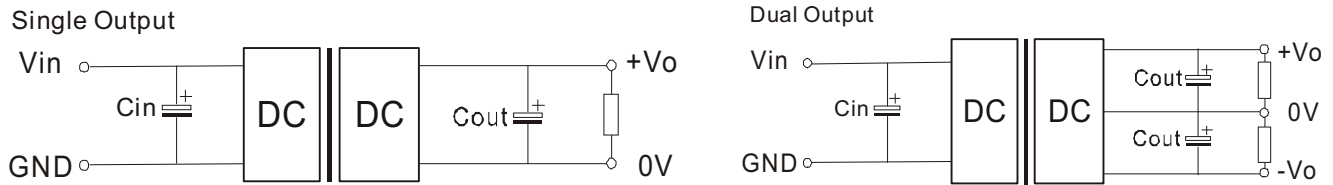

Table 3

| V_{in} (Vdc) | C_{in} (μF) | C_{out} (μF) |
|----------------|----------------------|-----------------------|
| 24 | 100 | 10 |
| 48 | 10~47 | 10 |

Table 4

| Single Vout (Vdc) | Max. Capacitive Load (μF) | Dual Vout (Vdc) | Max. Capacitive Load ¹ (μF) |
|-------------------|----------------------------------|-----------------|-----------------------------------------------|
| 3.3 | 1800 | -- | -- |
| 5 | 1000 | ± 5 | 470 |
| 12 | 100 | ± 12 | 100 |
| 15 | 100 | ± 15 | 100 |
| 24 | 47 | -- | -- |

Note: 1. For each output.

Note: 1. Minimum load shouldn't be less than 5%, otherwise ripple may increase dramatically. Operation under minimum load will not damage the converter, however, they may not meet all specifications listed.
 2. Maximum capacitive load is tested at input voltage range and full load.
 3. All specifications are measured at $T_a=25^\circ C$, humidity < 75%, nominal input voltage and rated output load unless otherwise specified.

REVISION HISTORY

| rev. | description | date |
|-------------|--------------------------|-------------|
| 1.0 | initial release | 06/17/2013 |
| 1.01 | added CE safety approval | 10/29/2013 |

The revision history provided is for informational purposes only and is believed to be accurate.



Headquarters
20050 SW 112th Ave.
Tualatin, OR 97062
800.275.4899

Fax 503.612.2383
cui.com
techsupport@cui.com

CUI offers a two (2) year limited warranty. Complete warranty information is listed on our website.

CUI reserves the right to make changes to the product at any time without notice. Information provided by CUI is believed to be accurate and reliable. However, no responsibility is assumed by CUI for its use, nor for any infringements of patents or other rights of third parties which may result from its use.

CUI products are not authorized or warranted for use as critical components in equipment that requires an extremely high level of reliability. A critical component is any component of a life support device or system whose failure to perform can be reasonably expected to cause the failure of the life support device or system, or to affect its safety or effectiveness.