





# T1/E1/CEPT/ISDN-PRI SMT TRANSFORMERS



-  Pick and place compatible
-  Isolation voltage: 1500Vrms minimum
-  Extended temperature range: -55°C to +125°C
-  Tape and Reel packaging available

## Electrical Specifications @ 25°C — Operating Temperature -55°C to +125°C

Part Number	Turns Ratio (Pri:Sec ±2%)	OCL Pri @ 25°C (mH MIN)	C <sub>ww</sub> (pF MAX)	DCR Pri (Ω MAX)	Primary Pins
PL1374	1CT:1CT	1.2	35	0.8	1-3

### Mechanical

### Schematics

#### PL1374

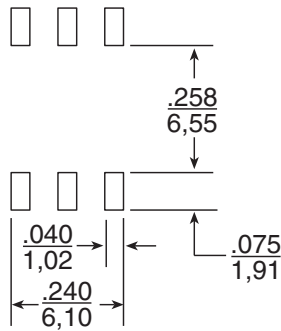
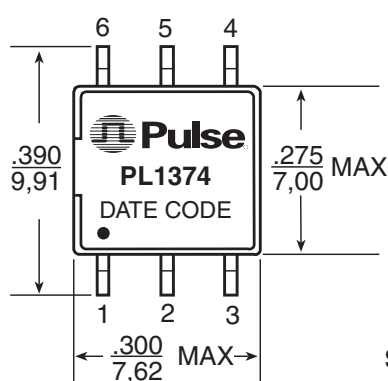

SUGGESTED PAD LAYOUT

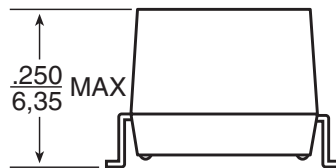
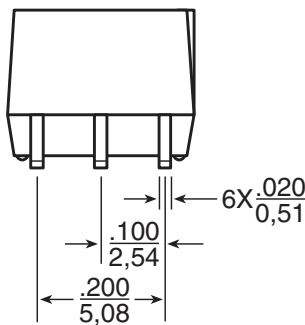
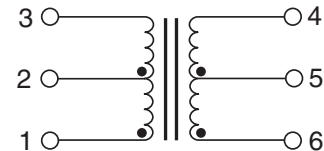

Weight .....0.6 grams  
 Tape & Reel .....500/reel  
 Tube .....70/tube  
 Dimensions:  $\frac{\text{Inches}}{\text{mm}}$   
 Unless otherwise specified,  
 all tolerances are  $\pm \frac{.010}{0,25}$

### For More Information:

#### Pulse Worldwide Headquarters

2 Pearl Buck Court  
 Bristol, PA 19007  
 U.S.A.

[www.pulseeng.com](http://www.pulseeng.com)

TEL: 215 781 6400

FAX: 215 781 6403

#### Pulse Europe

Einsteinstrasse 1  
 D-71083 Herrenberg  
 Germany

Tel: 49 7032 7806 116

Fax: 49 7032 7806 135

#### Pulse China Headquarters

No. 1  
 Industrial District  
 Changan, Dongguan  
 China

Tel: 86 769 85538070

Fax: 86 769 85538870

#### Pulse North China

Room 1503  
 XinYin Building  
 No. 888 YiShan Rd.  
 Shanghai 200233  
 China

Tel: 86 21 54643211/2

Fax: 86 21 54643210

#### Pulse South Asia

150 Kampong Ampat  
 #07-01/02  
 KA Centre  
 Singapore 368324

Tel: 65 6287 8998

Fax: 65 6280 0080

#### Pulse North Asia

No. 26  
 Kao Ching Rd.  
 Yang Mei Chen  
 Taoyuan Hsien  
 Taiwan, R. O. C.

Tel: 886 3 4641811

Fax: 886 3 4641911

Performance warranty of products offered on this data sheet is limited to the parameters specified. Data is subject to change without notice. Other brand and product names mentioned herein may be trademarks or registered trademarks of their respective owners.

© Copyright, 2006. Pulse Engineering, Inc. All rights reserved.

[www.pulseeng.com](http://www.pulseeng.com)

M119.A (7/06)