

SERIES: PEME1-S | DESCRIPTION: DC-DC CONVERTER
FEATURES

- 1 W isolated output
- unregulated output
- compact SIP package
- single/dual output models
- continuous short circuit protection
- extended temperature range (-40~105°C)
- 3 kVdc isolation
- no load input current as low as 5 mA
- UL 62368 approval
- efficiency up to 85%

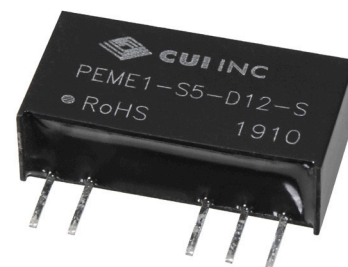

MODEL	input voltage		output voltage (Vdc)	output current		output power max (W)	ripple & noise ¹ max (mVp-p)	efficiency ² typ (%)
	typ (Vdc)	range (Vdc)		min (mA)	max (mA)			
PEME1-S5-S3-S	5	4.5~5.5	3.3	30	303	1	75	74
PEME1-S5-S5-S	5	4.5~5.5	5	20	200	1	75	82
PEME1-S5-S9-S	5	4.5~5.5	9	12	111	1	75	83
PEME1-S5-S12-S	5	4.5~5.5	12	9	84	1	75	83
PEME1-S5-S15-S	5	4.5~5.5	15	7	67	1	75	83
PEME1-S5-S24-S	5	4.5~5.5	24	4	42	1	100	85
PEME1-S5-D3-S ³	5	4.5~5.5	±3.3	±15	±152	1	75	74
PEME1-S5-D5-S	5	4.5~5.5	±5	±10	±100	1	75	82
PEME1-S5-D9-S	5	4.5~5.5	±9	±6	±56	1	75	83
PEME1-S5-D12-S	5	4.5~5.5	±12	±5	±42	1	75	83
PEME1-S5-D15-S	5	4.5~5.5	±15	±4	±34	1	75	83
PEME1-S5-D24-S	5	4.5~5.5	±24	±3	±21	1	100	85

- Notes:
1. Measured at nominal input, 20 MHz bandwidth oscilloscope, with 10 μ F tantalum and 1 μ F ceramic capacitors on the output.
 2. Measured at nominal input voltage, full load.
 3. Model is not UL or CE certified.
 4. All specifications are measured at $T_a=25^\circ\text{C}$, humidity < 75%, nominal input voltage, and rated output load unless otherwise specified.

PART NUMBER KEY

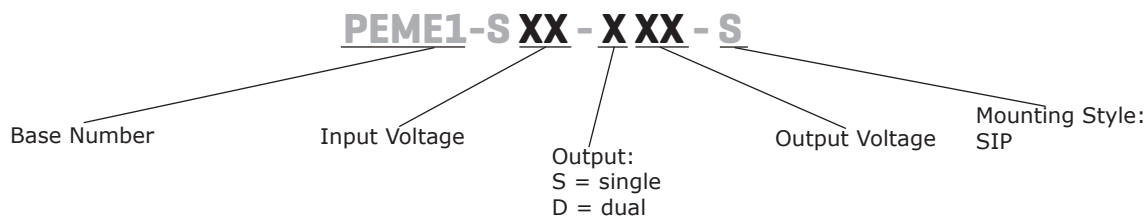

INPUT

parameter	conditions/description	min	typ	max	units
operating input voltage		4.5	5	5.5	Vdc
surge voltage	for maximum of 1 second	-0.7		9	Vdc
current	3.3, 5 Vdc output models 9, 12 Vdc output models all other models			286 254 254	mA mA mA
filter	filter capacitor				

OUTPUT

parameter	conditions/description	min	typ	max	units
maximum capacitive load ⁵	3.3, 5 Vdc output models			2,400	μF
	9 Vdc output models			1,000	μF
	12, 15 Vdc output models			560	μF
	24, ±12, ±15 Vdc output models			220	μF
	±3.3, ±5 Vdc output models			1,200	μF
	±9 Vdc output models all other models			470 100	μF μF
voltage accuracy	see tolerance envelope curves				
line regulation	for Vin change of 1%				
	3.3 Vdc output models all other models			±1.5 ±1.2	% %
load regulation	from 10% to full load				
	3.3 Vdc output models			±20	%
	5 Vdc output models all other models			±15 ±10	% %
switching frequency	at nominal input, full load		270		kHz
temperature coefficient	at full load		±0.02		%/°C

Note: 5. Tested at input voltage range and full load.

PROTECTIONS

parameter	conditions/description	min	typ	max	units
short circuit protection	continuous, self recovery				

SAFETY AND COMPLIANCE

parameter	conditions/description	min	typ	max	units
isolation voltage	input to output for 1 minute at 1 mA	3,000			Vdc
isolation resistance	input to output at 500 Vdc	1,000			MΩ
isolation capacitance	input to output, 100 kHz / 0.1 V		20		pF
safety approvals ⁶	UL 62368-1, EN 62368-1				
conducted emissions	CISPR32/EN55032, class B (external circuit required, see Figure 3)				

Note: 6. Model PEME1-S5-D3-S does not have UL or CE certification.

SAFETY AND COMPLIANCE (CONTINUED)

parameter	conditions/description	min	typ	max	units
radiated emissions	CISPR32/EN55032, class B (external circuit required, see Figure 3)				
ESD	IEC/EN61000-4-2, air \pm 8 kV; contact \pm 4 kV, class B				
MTBF	as per MIL-HDBK-217F, 25°C	3,500,000			hours
RoHS	yes				

ENVIRONMENTAL

parameter	conditions/description	min	typ	max	units
operating temperature	see derating curves	-40		105	°C
storage temperature		-55		125	°C
storage humidity	non-condensing			95	%
case temperature rise	3.3 Vdc output model at 25°C all other models at 25°C		25 15		°C °C

DERATING CURVES

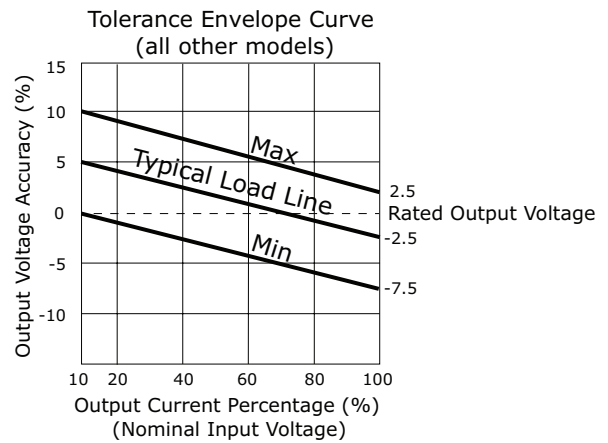
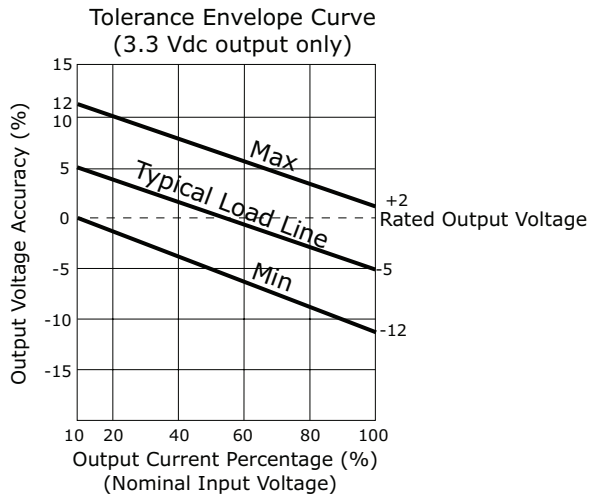

Temperature Derating Curve
(Natural Convection)

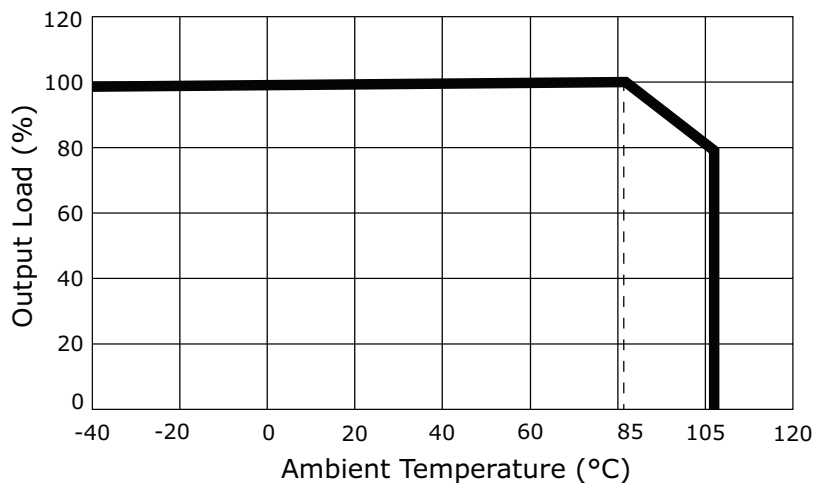

SOLDERABILITY

parameter	conditions/description	min	typ	max	units
hand soldering	1.5 mm from case for 10 seconds			300	°C
wave soldering	see wave soldering profile			260	°C

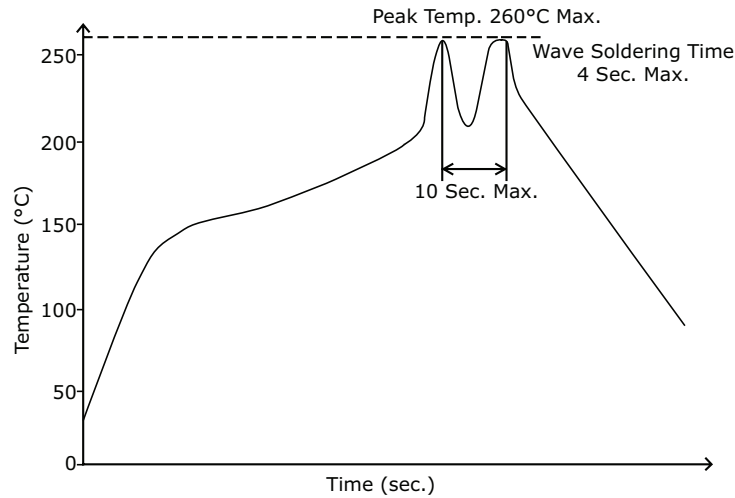

MECHANICAL

parameter	conditions/description	min	typ	max	units
dimensions	19.65 x 6.00 x 10.16 [0.774 x 0.236 x 0.400 inch]				mm
case material	black flame-retardant and heat-resistant plastic (UL94V-0)				
weight			2.1		g

MECHANICAL DRAWING

units: mm [inch]
 tolerance: $\pm 0.25[\pm 0.010]$
 pin section tolerance: $\pm 0.10[\pm 0.004]$

PIN CONNECTIONS		
PIN	Function	
	Single	Dual
1	Vin	Vin
2	GND	GND
5	0V	-Vout
6	No Pin	0V
7	+Vout	+Vout

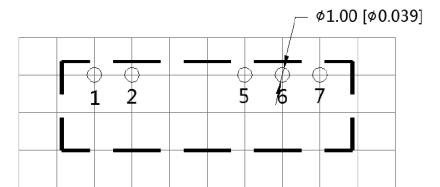
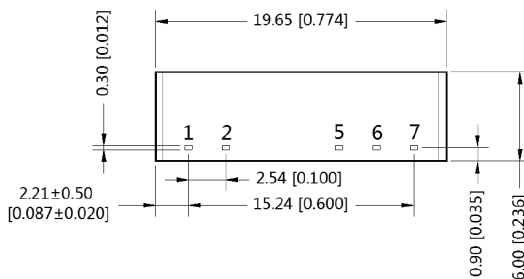
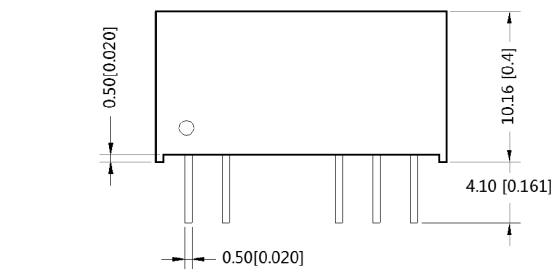

Note : Grid 2.54*2.54mm
 Recommended PCB Layout
 Top View

APPLICATION CIRCUIT

If you want to further reduce the input and output ripple, a filter capacitor may be connected to the input and output terminals (Figures 1 & 2) provided that the capacitance is less than the maximum capacitive load of the model, otherwise start-up problems may be caused if the capacitance is too large.

Figure 1
Single Output Models

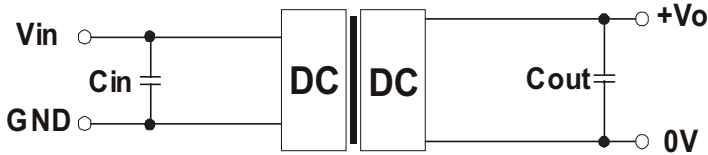

Table 1

Vin (Vdc)	Cin (μF)	Vo (Vdc)	Cout (μF)
5	4.7	3.3, 5	10
		9, 12	2.2
		15, 24	1

Figure 2
Dual Output Models

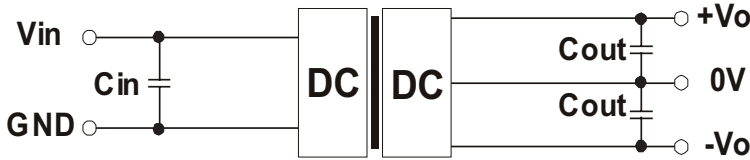

Table 2

Vin (Vdc)	Cin (μF)	Vo (Vdc)	Cout (μF)
5	4.7	±3.3, ±5	4.7
		±9, ±12	1
		±15, ±24	0.47

EMC RECOMMENDED CIRCUIT

Figure 3

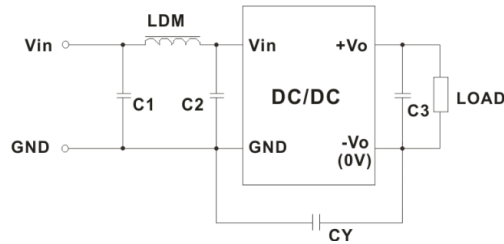

Table 3

Recommended External Circuit Components		
Vo (Vdc)	3.3, 5, 9	12, 15, 24
CY	--	1 nF / 4kVdc
C3	refer to Cout in Tables 1, 2	
C1, C2	4.7 μF / 25 V	4.7 μF / 25 V
LDM	6.8 μH	6.8 μH

PACKAGING

units: mm

Tube Size: 16.9 x 9.6 mm

Inner Carton Size: 575 x 135 x 100 mm

Outer Carton Size: 610 x 285 x 125 mm

Outer Carton QTY: 3,200 pcs

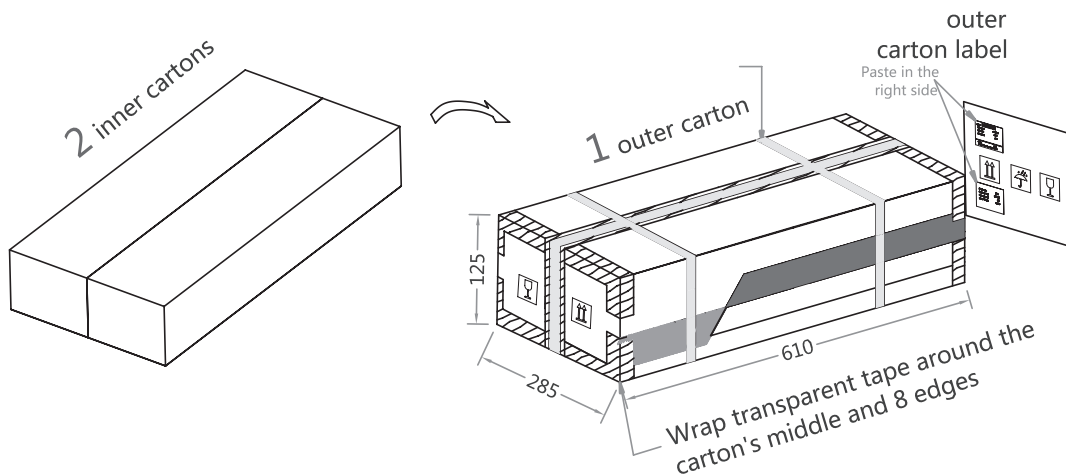
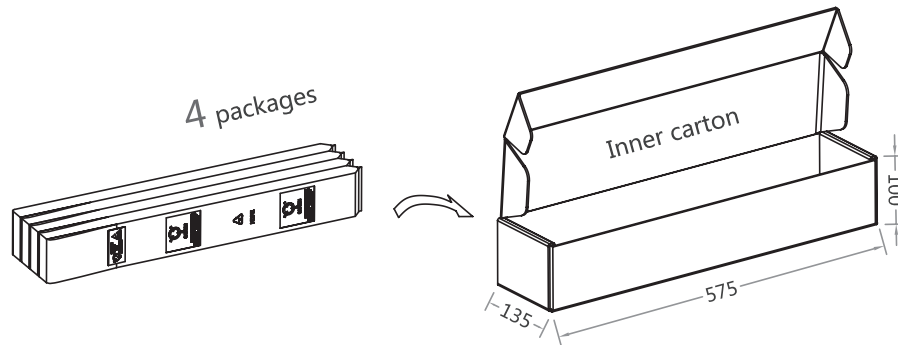
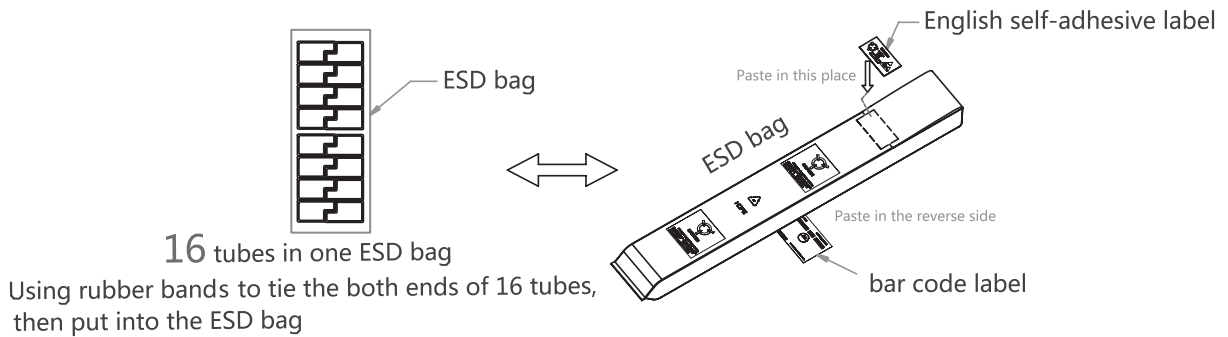
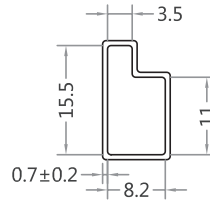
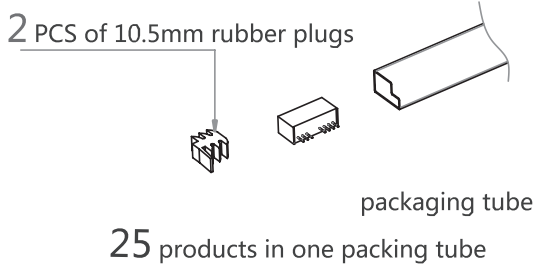

REVISION HISTORY

rev.	description	date
1.0	initial release	05/10/2019

The revision history provided is for informational purposes only and is believed to be accurate.



CUI INC[®]

Headquarters
20050 SW 112th Ave.
Tualatin, OR 97062
800.275.4899

Fax 503.612.2383
cui.com
techsupport@cui.com

CUI offers a two (2) year limited warranty. Complete warranty information is listed on our website.

CUI reserves the right to make changes to the product at any time without notice. Information provided by CUI is believed to be accurate and reliable. However, no responsibility is assumed by CUI for its use, nor for any infringements of patents or other rights of third parties which may result from its use.

CUI products are not authorized or warranted for use as critical components in equipment that requires an extremely high level of reliability. A critical component is any component of a life support device or system whose failure to perform can be reasonably expected to cause the failure of the life support device or system, or to affect its safety or effectiveness.