

SERIES: P78-2000R-S | DESCRIPTION: NON-ISOLATED SWITCHING REGULATOR
FEATURES

- 2 A output current
- 3 ~ 12 Vdc output options
- 36 Vdc max input voltage
- -40°C to +85°C temperature range
- pin compatible with LM78XX linear regulators
- wide input voltage range
- no-load input current as low as 0.1 mA
- designed to meet EN/IEC/BS EN 62368



MODEL	input voltage ¹		output voltage (Vdc)	output current max (mA)	output power max (W)	ripple and noise ² max (mVp-p)	efficiency ³ typ (%)
	typ (Vdc)	range (Vdc)					
P7803-2000R-S	24	6 ~ 36	3.3	2000	6.6	75	89
P7805-2000R-S	24	8 ~ 36	5	2000	10.0	75	92
P7812-2000R-S	24	16 ~ 36	12	2000	24.0	75	96

Notes:

1. For input voltage exceeding 30 Vdc, an input capacitor of 22µF/50V is required.
2. The ripple and noise are measured at 20 MHz BW using the parallel cable method at nominal input voltage, full load. See Application notes.
3. Measured at minimum Vin and 100% load.

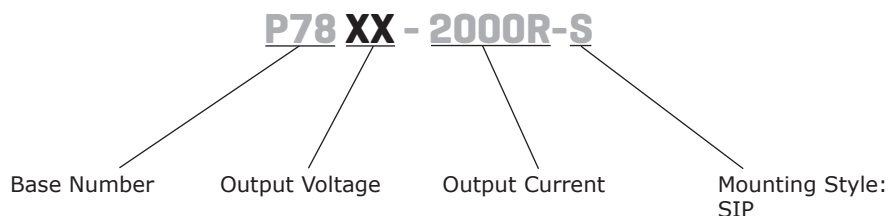
PART NUMBER KEY

INPUT

parameter	conditions/description	min	typ	max	units
no load input current (positive output)	at nominal input			1	mA
reverse polarity at input	avoid / not protected				
input filter	capacitance filter				

OUTPUT

parameter	conditions/description	min	typ	max	units
line regulation	Vin = min ~ max, at full load		±0.4	±0.8	%
load regulation	at nominal input, 10% ~ 100% load		±0.5	±1.5	%
voltage accuracy	at nominal input, 10% ~ 100% load			±3.0	%
switching frequency	at nominal input, full load		400		kHz
temperature coefficient	-40°C ~ 80°C			±0.03	%/°C
transient response deviation	at nominal input, 25% load step change (25%~50%~25%, 50%~75%~50% step)		±50	±150	mV
transient recovery time	at nominal input, 25% load step change (25%~50%~25%, 50%~75%~50% step)		0.2	1	ms

PROTECTIONS

parameter	conditions/description	min	typ	max	units
short circuit protection	continuous, auto recovery				

SAFETY AND COMPLIANCE

parameter	conditions/description	min	typ	max	units
safety approvals	designed to meet 62368: EN, IEC, UKCA				
conducted emissions	CISPR32/EN55032 CLASS B (see Fig. 2-2 for recommended circuit)				
radiated emissions	CISPR32/EN55032 CLASS B (see Fig. 2-2 for recommended circuit)				
ESD	IEC/EN 61000-4-2 Contact ±6kV, perf. Criteria B				
radiated immunity	IEC/EN 61000-4-3 10V/m, perf. Criteria A				
EFT/burst	IEC/EN 61000-4-4 ±1kV, perf. Criteria B (see Fig. 2-1 for recommended circuit)				
surge	IEC/EN 61000-4-5 line to line ±1kV, perf. Criteria B (see Fig. 2-1 for recommended circuit)				
conducted immunity	IEC/EN 61000-4-6 3Vr.m.s, perf. Criteria A				
MTBF	as per MIL-HDBK-217 at 25°C	2,000,000			hours
RoHS compliant	yes				

ENVIRONMENTAL

parameter	conditions/description	min	typ	max	units
operating temperature	see derating curves	-40		85	°C
storage temperature		-55		125	°C
storage humidity	non-condensing	5		95	%
pin soldering resistance temperature	for max 10 seconds			260	°C

DERATING CURVES

**TEMPERATURE DERATING CURVE
(3.3 Vdc & 5 Vdc output models)**

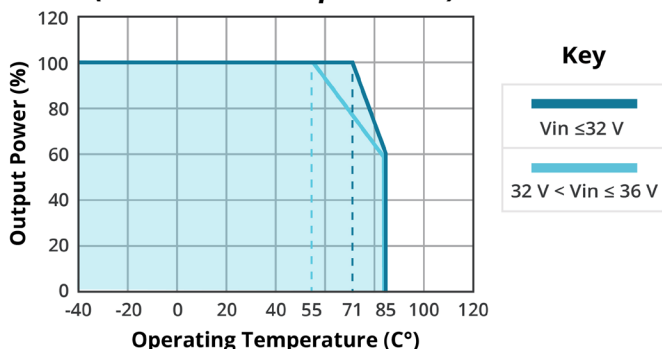

**TEMPERATURE DERATING CURVE
(12 Vdc output model)**

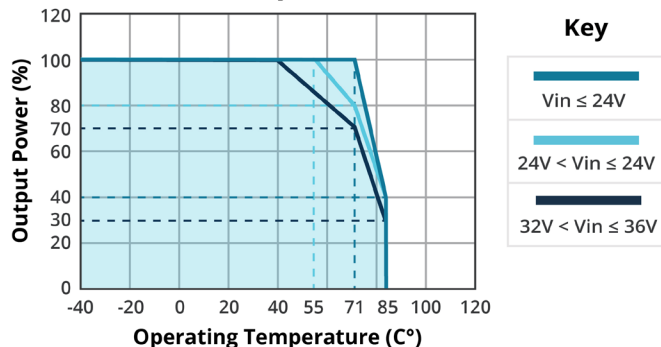

MECHANICAL

parameter	conditions/description	min	typ	max	units
dimensions	17.50 x 11.50 x 9.00 [0.689 x 0.453 x 0.354 inch]				mm
case material	black plastic, flame retardant and heat resistant (UL94-V0)				
weight			3.8		g
cooling	natural convection				

MECHANICAL DRAWING

units: mm [inches]
 tolerance: ±0.50 [±0.020]
 pin section tolerance: ±0.10 mm [±0.004]

PIN CONNECTIONS	
PIN	FUNCTION
1	+Vin
2	GND
3	+Vo

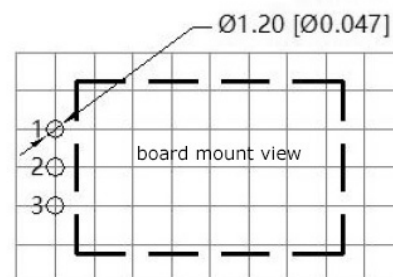
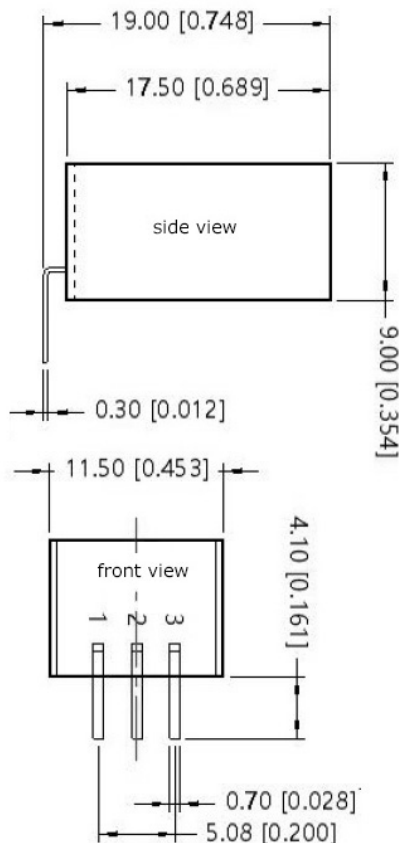

Note : Grid 2.54*2.54mm

TYPICAL APPLICATION CIRCUIT

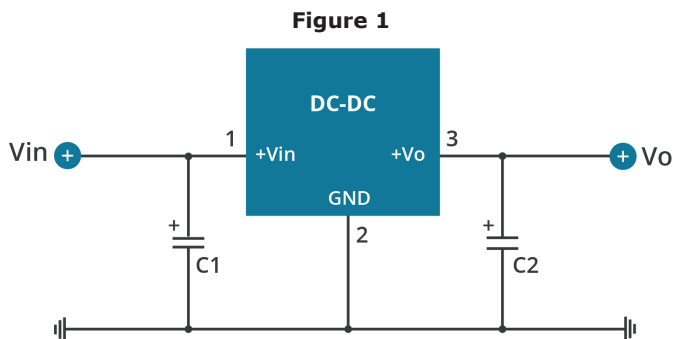

Table 1

Output Voltage (Vdc)	C1 (ceramic capacitor)	C2 (ceramic capacitor)
3.3	22 μ F/50V	22 μ F/10V
5		22 μ F/10V
12		22 μ F/25V

1. The required C1 and C2 capacitors must be connected as close as possible to the module.
2. Refer to Table 1 for C1 and C2 capacitor values. For certain applications, increased values and/or tantalum or low ESR electrolytic capacitors may also be used instead.
3. For certain applications, increased values of C2 and/or tantalum or low ESR electrolytic capacitors may also be used instead.
3. Converter cannot be used for hot swap and with output in parallel.

EMC RECOMMENDED CIRCUIT

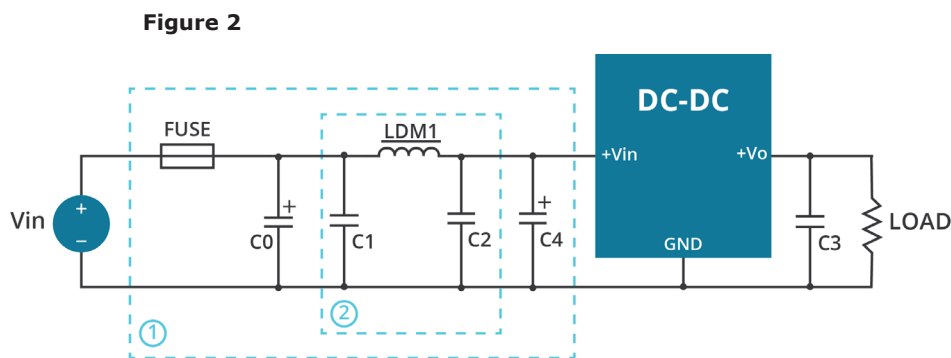
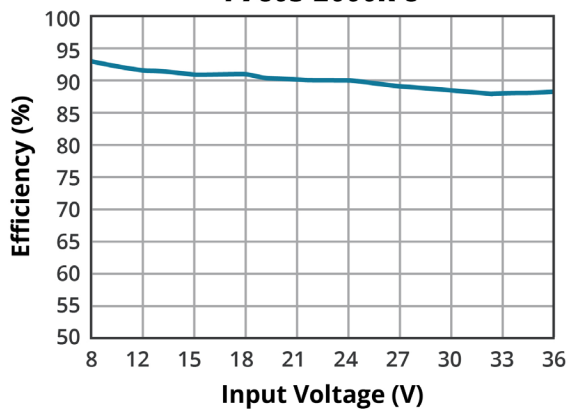

Table 2

Component	Recommended value
FUUSE	selected based on the actual input current in application
C0	100 μ F/100V
LDM1	22 μ H
C4	680 μ F/50V
C1	10 μ F/50V
C2	10 μ F/50V
C3	22 μ F/25V

EFFICIENCY CURVES

EFFICIENCY VS INPUT VOLTAGE
(full load)
P7805-2000R-S



EFFICIENCY VS OUTPUT CURRENT
($V_{in} = 24V$)
P7805-2000R-S

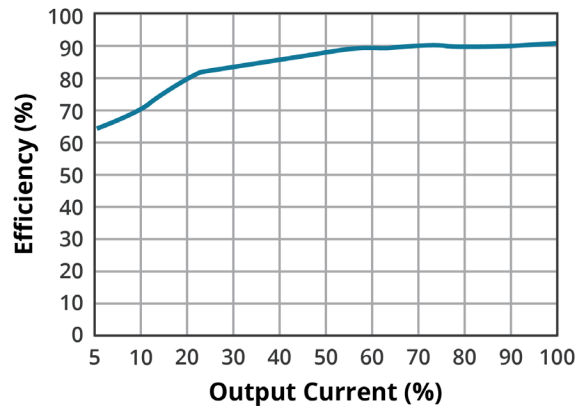

REVISION HISTORY

rev.	description	date
1.0	initial release	07/31/2022
1.01	updated efficiency	08/08/2022

The revision history provided is for informational purposes only and is believed to be accurate.



CUI INC
a bel group

Headquarters
20050 SW 112th Ave.
Tualatin, OR 97062
800.275.4899

Fax 503.612.2383
cui.com
techsupport@cui.com

CUI offers a two (2) year limited warranty. Complete warranty information is listed on our website.

CUI reserves the right to make changes to the product at any time without notice. Information provided by CUI is believed to be accurate and reliable. However, no responsibility is assumed by CUI for its use, nor for any infringements of patents or other rights of third parties which may result from its use.

CUI products are not authorized or warranted for use as critical components in equipment that requires an extremely high level of reliability. A critical component is any component of a life support device or system whose failure to perform can be reasonably expected to cause the failure of the life support device or system, or to affect its safety or effectiveness.