

P4 series auxiliary actuators are designed to work with OTTO B2 (Single-break) and B3 (Double-break) basic switches. Auxiliary type actuators offer a wide variety of styles and types. Special basic switch characteristics can be specified to match your application needs.

Unsealed Construction

These unsealed pushbutton actuators feature a choice of 1/4 and 15/32 inch mounting bushings with nylon buttons available in 9 colors. Choose single, two, three and four pole models. To order standard models, use part number code shown below.

Number Of Poles	Operating Force (Oz.)	Release Force (Oz.)
1	8	2
2	16	2
3	24	3
4	32	4

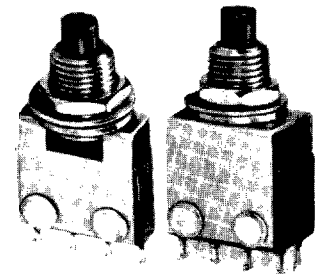
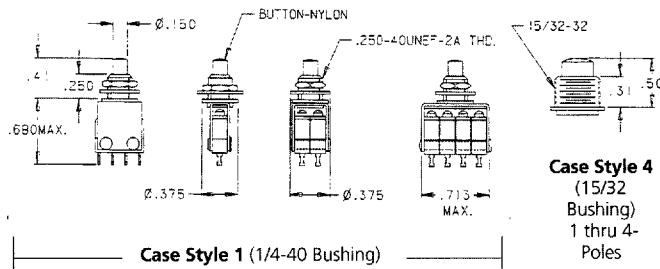

Sealed Construction

Moisture-proof at the front panel. Choice of one and two pole configurations. Select from 6 bezel/bushing mount case styles in clear (silver) or black anodized aluminum. Styles C, H and F are illustrated here. For styles A, B, and G, see P1 series information. Buttons are available in nine colors. Basic switches are per MIL-S-8805/101. Operating Force is 4 lbs. max. Use Part Number Code below to specify your requirements.

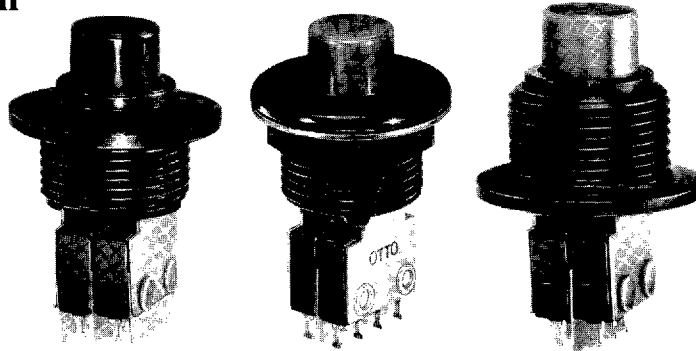

RFI Shielding Option with Moisture-Proof Panel Seal

RFI shielding can be included along with the moisture-proof sealing feature in Case Styles C, F, and H, in two-pole momentary action. Case Styles are illustrated at left. RFI shielding is not available in P4 bezel Style 1 (1/4-40) and Style 4 (15/32-32) bushing types. The plunger seal is dust tight and moisture-proof. Basic switches per MIL-S-8805/101.

Operating Force: 5 lbs. max. To order, see part number code below.

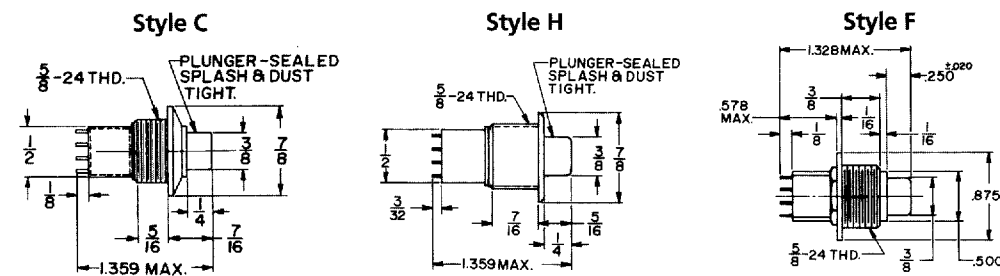

Only Case Styles C, F and H are shown here. See P1 Series information for Case Styles A, B, and G case styles.

ORDERING INFORMATION

Standard Auxiliary Actuator Assemblies for Basics

Select the OTTO P4 Series pushbutton switch assembly to match your specific application needs. Standard and special features are shown at right. Specify your choice by building the OTTO Part Numbering Code. Example: P4-614121 features the style "F" case, DPDT (4 terminals each), p.c. terminals, single step momentary action, black bezel with red button.

Notes:

- ① Specials are serialized. Subsequent numerals do not specify standard features.
- ② Available in Case Styles 1 and 4 only.
- ③ Available in Case Styles C, F and H. Available in two-pole only.
- ④ See P1 Series information for front panel appearance details.

OTTO PART NUMBER CODE

Use these codes to specify the characteristics required for your application

P4- X X X X X X

CASE STYLE	TERMINAL STYLE	CIRCUIT FORM	SWITCHING ACTION	BEZEL COLOR	BUTTON COLOR
1. 1/4-40 THD	0. Special ①	1. SPDT-3 Term.	1. Momentary	1. Silver	1. Red
2. "B" Style ④	1. P.C. Term	2. SPDT-4 Term.	2. Two step ③	2. Black	2. Black
3. "C" Style	2. Turret	3. DPDT-6 Term.	3. RFI Shielded ③ (Momentary)	3. Orange	3. Orange
4. 15/32 THD	3. Wire Wrap	4. DPDT-8 Term.		4. Yellow	4. Yellow
5. "A" Style ④		5. 3PDT-9 Term. ②		5. Green	5. Green
6. "F" Style		6. 3PDT-12 Term. ②		6. Blue	6. Blue
7. "G" Style ④		7. 4PDT-12 Term. ②		7. Purple	7. Purple
8. "H" Style		8. 4PDT-16 Term. ②		8. Gray	8. Gray
9. Special ①				9. White	9. White

Please turn page for additional auxiliary pushbutton actuators ▶

Rugged Panel Sealed

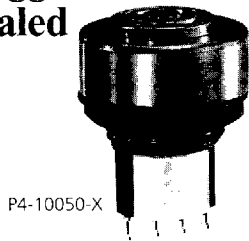

P4-10050-X

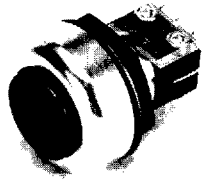

P4-10149-X

These rugged sealed aluminum pushbutton actuators are anodized in a variety of colors. Available in one and two pole models. An "O" ring provides the panel seal to keep out water and dust from the basic switches behind the panel.

To order: Please use table at right.

Operating Force:

- 1 Pole: 2.5 lbs., max.
- 2 Pole: 4.0 lbs.

Part No. SPDT-DB	Part No. DPDT-DB	Button Color
P4-10050-1	P4-10149-1	Red
P4-10050-2	P4-10149-2	Black
P4-10050-3	P4-10149-3	Orange
P4-10050-4	P4-10149-4	Yellow
P4-10050-5	P4-10149-5	Green
P4-10050-6	P4-10149-6	Blue
P4-10050-7	P4-10149-7	Purple
P4-10050-8	P4-10149-8	Gray
P4-10050-9	P4-10149-9	Clear

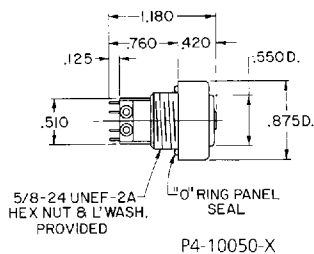

P4-10050-X

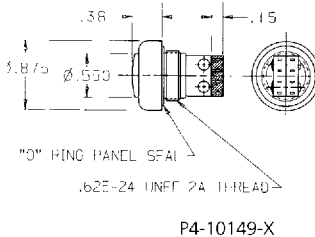

P4-10149-X

Standard Sealed TwoStep™

Ideal for applications requiring three modes of operation: "Off", Level 1, and Level 2. Plunger seal is dust tight and moisture-proof. Available in P1 series Bezel Styles C, F, and H. Two pole only.

Standard Operating Force:

Position 1: 2.25 lbs. max.

Position 2: 3.25 lbs. max.

Total Travel: .140 inches max.

To Order: Use Part Number Code, page 19.

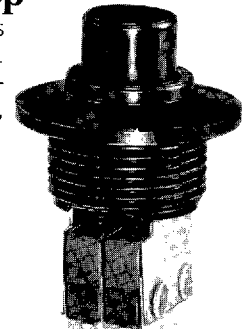

Sequence Of Action

Full Out

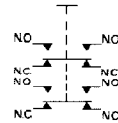

Position 1

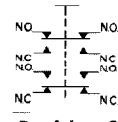

Position 2

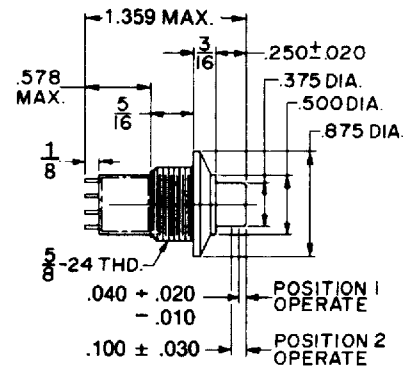
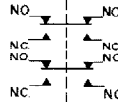

Miniature, Offset Pushbutton

This miniature switch features an offset pushbutton to clear back of panel interference, stainless steel bushing, natural acetal button.

Operating Force: 8 oz. max.

Rated: 1 Ampere Resistive.

Circuit: SPDT

Electrical Life: 25,000 cycles.

Mechanical Life: 50,000 cycles.

P4-900027



Special TwoStep™ Pushbutton. Dust Tight Sealed

Rating: 5 Amperes Resistive

3 Amperes Inductive @ 28 VDC

Circuit: 2-SPDT.

Switch "A" operates at Level 1.

Stays "on" when Level 2 operates Switch "B".

Operating Force:

Level #1: 1.75 ± .5 lbs.

Level #2: 2.75 ± .5 lbs.

Button: Red nylon.

P4-20002

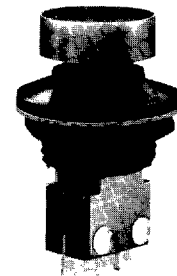

"F" Style Sealed, 2-Pole

Moisture-proof and Dust-Tight sealed switch features the "F" style bezel, as illustrated on previous page. Button is molded of gray nylon.

Operating Force: 4 lbs. ± 1 lb.

Total Travel: .100" max.

Circuit: DPNO-DB

Rated: 10 Amperes, Resistive

5 Amperes, Inductive

Electrical Life: 25,000 cycles.

Mechanical Life: 50,000 cycles.

P4-600009

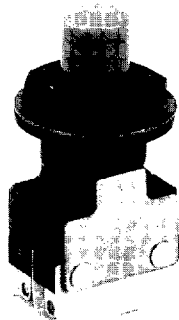

Splash & Dust Tight Sealed, 2 Pole, 4-circuit

Button: black nylon.

Operating force is 4 lbs. ± 1 lb.

Circuit is DPDT-4 circuit.

Resistive: 5 amperes

Inductive: 3 amperes.

Contacts are gold plated per

MIL-S-8805/101-010.

P4-10044



**Square Button,
Single Pole 2-Circuit**

This subminiature pushbutton switch features a button molded of Lexan.
Rating: 5 Amperes, Resistive
3 Amperes, Inductive.
Contacts are gold plated.
Operating force is 24 ±4 ounces.
White and other colors available.
P4-300015



Vandal-Proof to Survive Abuse

Brass plated dull nickel housing and button is watertight sealed. Ideal for unattended machines operated by the public. Bezel .969" dia., button .600" dia.
Total travel: .100" max.
Operating Force: 4.0 lbs. max.
Mechanical Life: 250,000 cycles
Circuit: DPNO-DB
P4-10155-2
For larger 1.5" dia., SPNO-DB design, see P1-90135-2, page 14.



**Water-Tight Panel Sealed
Double Pole.**

Dress ring has "O" ring provision for water-tight panel seal.
Button and case are black.
Switch uses MIL-S-8805/101 basics.
Seal is water-tight.
Operating Force is 4 lbs.
P4-900003



1/4-40 Bushing, SPDT- 2-Circuit

This subminiature pushbutton switch features an anti-turn device to facilitate installation. Bushing and bracket are stainless steel. Button is nylon.
Operating force is 10 ounce max.
Rated 8 Amperes, 28VDC.
P4-10029

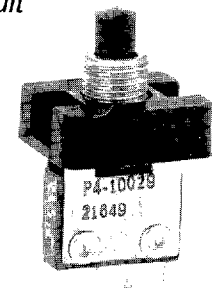

6 Pole, Right Angle, P.C. Mount.

Solders into printed circuit board.
Basic switches per MIL-S-8805/4.
Operating Force is 3.5 lbs. max.
Rated 1 Ampere, Resistive.
Gold contacts.
Choice of nine button colors.
P4-10073 plus Button Color designation

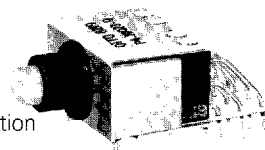

**2 Pole, Right Angle, Bushing Mount
Single & TwoStep™ Versions**

Right angle bushing mount assembly of basic switches.
Either 2-mode momentary or 3-mode TwoStep (Off-Level 1-Level 2) action.
Plunger is red Nylon. Other colors available.
Bushing is stainless steel.
Rated 8 Amperes, Resistive.
Operating force is 24 ±4 ounces.
Single Level: P4-10022
TwoStep™: P4-20003

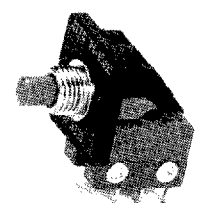

8 Pole, Positive Detent, Sealed.

Rating: 1 Ampere, Resistive
.5 Amperes, Inductive
Circuit: 8 PDT
Materials:
Bracket: Stainless Steel
Bushing: Aluminum,
Black anodized.
Button: Nylon, choice of
9 colors.
P4-10082 plus button color designation

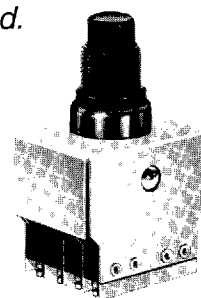

Shroud Protected Button, 2 Pole.

Button is protected against accidental actuation by a black anodized shroud. Button is red nylon.
Rating: 5 Amperes Resistive
2 Amperes, Inductive at 28VDC.
Operating force is 4 lbs. ± 1 lb.
P4-900013

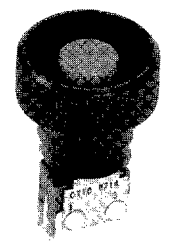

**Miniature with Shrouded Pushbutton
Unsealed**

Rating: 8 Amperes, Resistive at 28 VDC
Circuit: DPDT-DB
Operating Force: 2.5 lbs. max
Total Travel: .070" max.
Housing: Clear anodized aluminum.
Button: Black Nylon
Plunger: Unsealed.
P4-10090



**Miniature with Shrouded Pushbutton
Dust-tight Sealed**

Rating: 8 Amperes, Resistive at 28 VDC
Circuit: DPDT-DB
Operating Force: 4 lbs. max
Total Travel: .100" max.
Housing: Black anodized aluminum.
Button: Black Nylon
Plunger: Dust-tight sealed.
P4-900019

