

NID6002N

Preferred Device

Self-Protected FET with Temperature and Current Limit

65 V, 6.5 A, Single N-Channel, DPAK

HDPlus™ devices are an advanced series of power MOSFETs which utilize ON Semiconductor's latest MOSFET technology process to achieve the lowest possible on-resistance per silicon area while incorporating smart features. Integrated thermal and current limits work together to provide short circuit protection. The devices feature an integrated Drain-to-Gate Clamp that enables them to withstand high energy in the avalanche mode. The Clamp also provides additional safety margin against unexpected voltage transients. Electrostatic Discharge (ESD) protection is provided by an integrated Gate-to-Source Clamp.

Features

- Short Circuit Protection/Current Limit
- Thermal Shutdown with Automatic Restart
- I_{DSS} Specified at Elevated Temperature
- Avalanche Energy Specified
- Slew Rate Control for Low Noise Switching
- Overvoltage Clamped Protection
- Pb-Free Package is Available



ON Semiconductor®

<http://onsemi.com>

V_{DSS} (Clamped)	$R_{DS(on)}$ TYP	I_D TYP (Limited)
65 V	210 mΩ	6.5 A

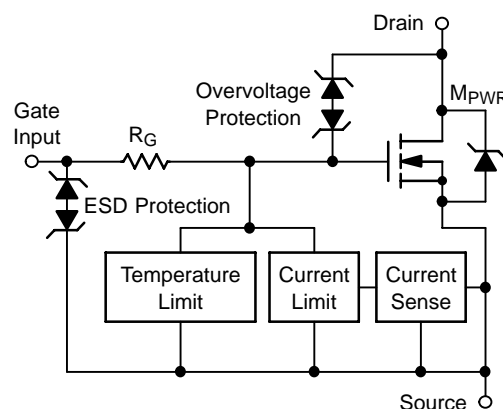

DPAK
CASE 369C
STYLE 2

MARKING DIAGRAM

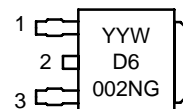

D6002N = Device Code
Y = Year
WW = Work Week
G = Pb-Free Device

1 = Gate
2 = Drain
3 = Source

ORDERING INFORMATION

Device	Package	Shipping†
NID6002NT4	DPAK	2500/Tape & Reel
NID6002NT4G	DPAK (Pb-Free)	2500/Tape & Reel

†For information on tape and reel specifications, including part orientation and tape sizes, please refer to our Tape and Reel Packaging Specification Brochure, BRD8011/D.

Preferred devices are recommended choices for future use and best overall value.

NID6002N

MOSFET MAXIMUM RATINGS (T_J = 25°C unless otherwise noted)

Rating	Symbol	Value	Unit
Drain-to-Source Voltage Internally Clamped	V _{DSS}	70	Vdc
Gate-to-Source Voltage	V _{GS}	± 14	Vdc
Drain Current	I _D	Internally Limited	
Total Power Dissipation @ T _A = 25°C (Note 1) @ T _A = 25°C (Note 2)	P _D	1.3 2.5	W
Thermal Resistance Junction-to-Case Junction-to-Ambient (Note 1) Junction-to-Ambient (Note 2)	R _{θJC} R _{θJA} R _{θJA}	3.0 95 50	°C/W
Single Pulse Drain-to-Source Avalanche Energy (V _{DD} = 50 Vdc, V _{GS} = 5.0 Vdc, I _L = 1.3 Apk, L = 160 mH, R _G = 25 Ω) (Note 3)	E _{AS}	143	mJ
Operating and Storage Temperature Range (Note 4)	T _J , T _{stg}	-55 to 150	°C

Stresses exceeding Maximum Ratings may damage the device. Maximum Ratings are stress ratings only. Functional operation above the Recommended Operating Conditions is not implied. Extended exposure to stresses above the Recommended Operating Conditions may affect device reliability.

1. Surface mounted onto minimum pad size (100 sq/mm) FR4 PCB, 1 oz cu.
2. Mounted onto 1" square pad size (700 sq/mm) FR4 PCB, 1 oz cu.
3. Not subject to production test.
4. Normal pre-fault operating range. See thermal limit range conditions.

NID6002N

MOSFET ELECTRICAL CHARACTERISTICS ($T_J = 25^\circ\text{C}$ unless otherwise noted)

Characteristic	Symbol	Min	Typ	Max	Unit
----------------	--------	-----	-----	-----	------

OFF CHARACTERISTICS

Drain-to-Source Clamped Breakdown Voltage ($V_{GS} = 0\text{ V}$, $I_D = 2\text{ mA}$)	$V_{(BR)DSS}$	60	65	70	V
Zero Gate Voltage Drain Current ($V_{DS} = 52\text{ V}$, $V_{GS} = 0\text{ V}$)	I_{DSS}	–	27	100	μA
Gate Input Current ($V_{GS} = 5.0\text{ V}$, $V_{DS} = 0\text{ V}$)	I_{GSS}	–	45	200	μA

ON CHARACTERISTICS

Gate Threshold Voltage ($V_{DS} = V_{GS}$, $I_D = 150\ \mu\text{A}$) Threshold Temperature Coefficient	$V_{GS(th)}$	1.0 –	1.85 5.0	2.4 –	V –mV/°C
Static Drain-to-Source On-Resistance (Note 5) ($V_{GS} = 10\text{ V}$, $I_D = 2.0\text{ A}$, $T_J @ 25^\circ\text{C}$)	$R_{DS(on)}$	–	185	210	m Ω
Static Drain-to-Source On-Resistance (Note 5) ($V_{GS} = 5.0\text{ V}$, $I_D = 2.0\text{ A}$, $T_J @ 25^\circ\text{C}$) ($V_{GS} = 5.0\text{ V}$, $I_D = 2.0\text{ A}$, $T_J @ 150^\circ\text{C}$)	$R_{DS(on)}$	– –	210 445	240 520	m Ω
Source-Drain Forward On Voltage ($I_S = 7.0\text{ A}$, $V_{GS} = 0\text{ V}$)	V_{SD}	–	0.9	1.1	V

SWITCHING CHARACTERISTICS (Note 8)

Turn-on Delay Time	$R_L = 6.6\ \Omega$, $V_{in} = 0\text{ to }10\text{ V}$, $V_{DD} = 13.8\text{ V}$, $I_D = 2.0\text{ A}$, 10% V_{in} to 10% I_D	$t_{d(on)}$	–	96	–	ns
Turn-on Rise Time	$R_L = 6.6\ \Omega$, $V_{in} = 0\text{ to }10\text{ V}$, $V_{DD} = 13.8\text{ V}$, $I_D = 2.0\text{ A}$, 10% I_D to 90% I_D	t_{rise}	–	250	–	ns
Turn-off Delay Time	$R_L = 6.6\ \Omega$, $V_{in} = 0\text{ to }10\text{ V}$, $V_{DD} = 13.8\text{ V}$, $I_D = 2.0\text{ A}$, 90% V_{in} to 90% I_D	$t_{d(off)}$	–	840	–	ns
Turn-off Fall Time	$R_L = 6.6\ \Omega$, $V_{in} = 0\text{ to }10\text{ V}$, $V_{DD} = 13.8\text{ V}$, $I_D = 2.0\text{ A}$, 90% I_D to 10% I_D	t_{fall}	–	660	–	ns
Slew Rate ON	$R_L = 6.6\ \Omega$, $V_{in} = 0\text{ to }10\text{ V}$, $V_{DD} = 13.8\text{ V}$, $I_D = 2.0\text{ A}$, 70% to 50% V_{DD}	dV_{DS}/dT_{on}	–	73	–	V/ μs
Slew Rate OFF	$R_L = 6.6\ \Omega$, $V_{in} = 0\text{ to }10\text{ V}$, $V_{DD} = 13.8\text{ V}$, $I_D = 2.0\text{ A}$, 50% to 70% V_{DD}	dV_{DS}/dT_{off}	–	35	–	V/ μs

SELF PROTECTION CHARACTERISTICS (Note 6)

Current Limit	$V_{DS} = 10\text{ V}$, $V_{GS} = 5.0\text{ V}$, $T_J = 25^\circ\text{C}$ (Note 7) $V_{DS} = 10\text{ V}$, $V_{GS} = 5.0\text{ V}$, $T_J = 130^\circ\text{C}$ (Notes 7, 8) $V_{DS} = 10\text{ V}$, $V_{GS} = 10\text{ V}$, $T_J = 25^\circ\text{C}$ (Notes 7, 8)	I_{LIM}	4.0 4.0 –	6.4 5.5 7.9	11 11 –	A
Temperature Limit (Turn-off)	$V_{GS} = 5.0\text{ V}$ (Note 8)	$T_{LIM(off)}$	150	180	200	°C
Thermal Hysteresis	$V_{GS} = 5.0\text{ V}$	$\Delta T_{LIM(on)}$	–	10	–	°C
Temperature Limit (Turn-off)	$V_{GS} = 10\text{ V}$ (Note 8)	$T_{LIM(off)}$	150	180	200	°C
Thermal Hysteresis	$V_{GS} = 10\text{ V}$	$\Delta T_{LIM(on)}$	–	20	–	°C
Input Current during Thermal Fault	$V_{DS} = 0\text{ V}$, $V_{GS} = 5.0\text{ V}$, $T_J = T_J > T_{(fault)}$ (Note 8) $V_{DS} = 0\text{ V}$, $V_{GS} = 10\text{ V}$, $T_J = T_J > T_{(fault)}$ (Note 8)	$I_{g(fault)}$	5.5 12	5.2 11	–	mA

ESD ELECTRICAL CHARACTERISTICS

Electro-Static Discharge Capability Human Body Model (HBM) Machine Model (MM)	ESD	8000 400	– –	– –	V
---	-----	-------------	--------	--------	---

5. Pulse Test: Pulse Width $\leq 300\ \mu\text{s}$, Duty Cycle $\leq 2\%$.
6. Fault conditions are viewed as beyond the normal operating range of the part.
7. Current limit measured at $380\ \mu\text{s}$ after gate pulse.
8. Not subject to production test.

TYPICAL PERFORMANCE CURVES

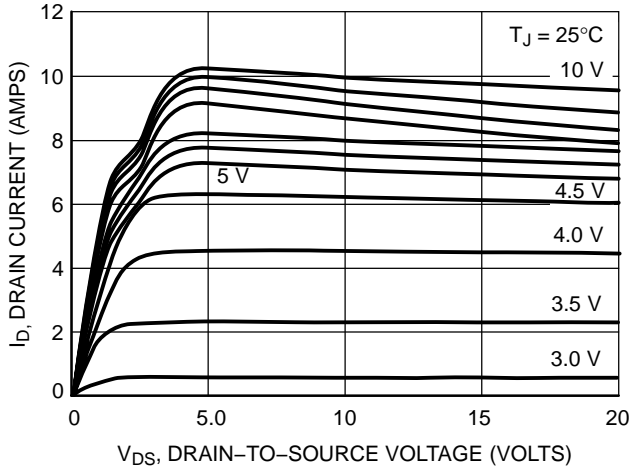

Figure 1. On-Region Characteristics

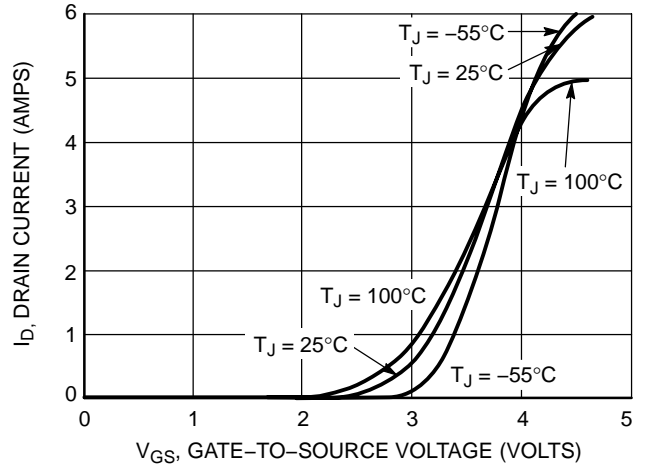

Figure 2. Transfer Characteristics

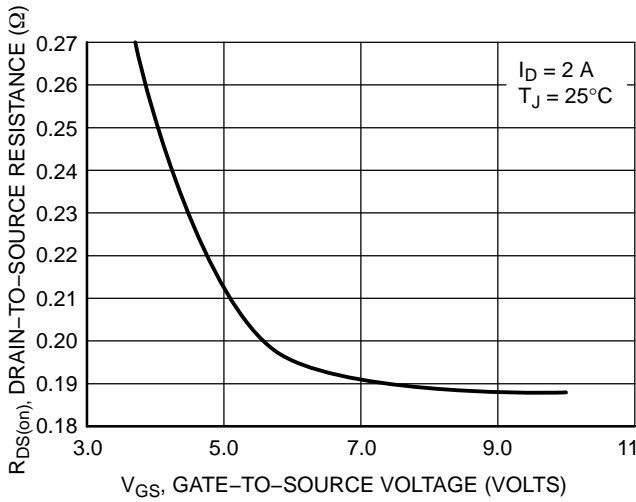

Figure 3. On-Resistance vs. Gate-to-Source Voltage

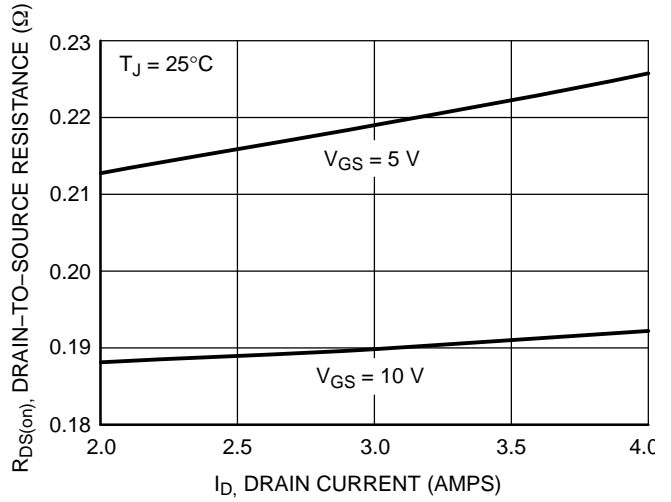

Figure 4. On-Resistance vs. Drain Current and Gate Voltage

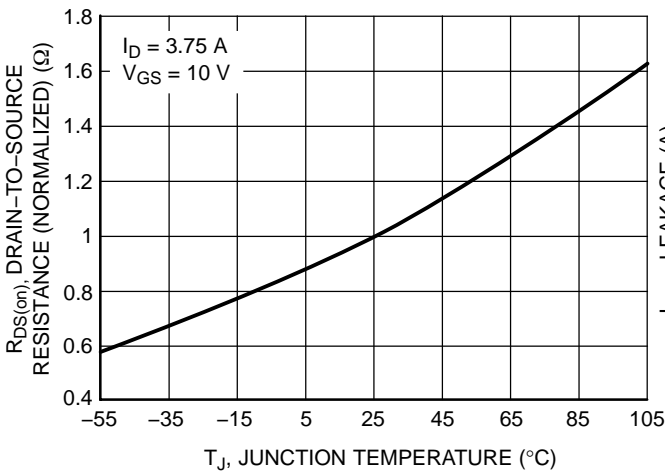

Figure 5. On-Resistance Variation with Temperature

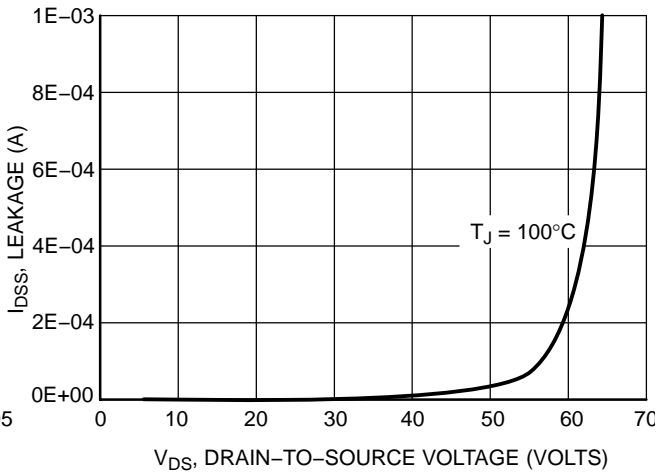

Figure 6. Drain-to-Source Leakage Current vs. Voltage

NID6002N

TYPICAL PERFORMANCE CURVES

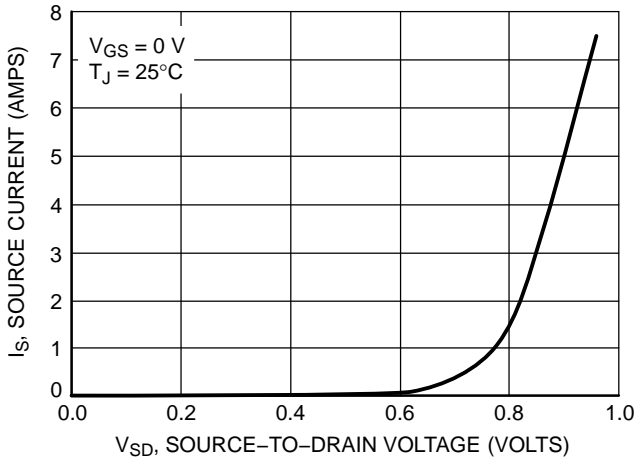

Figure 7. Diode Forward Voltage vs. Current

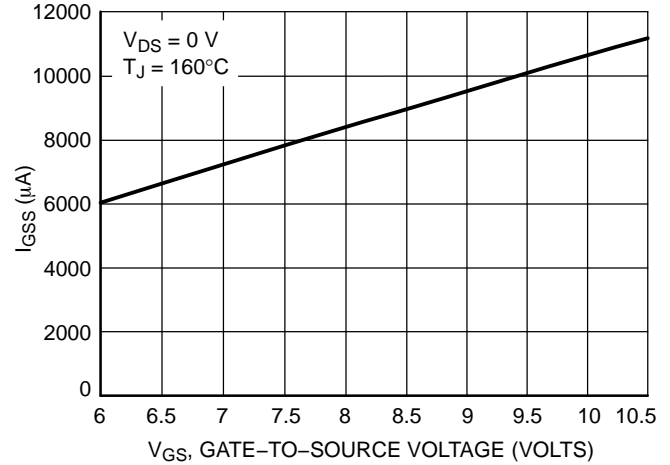

Figure 8. Input Current vs. Gate Voltage

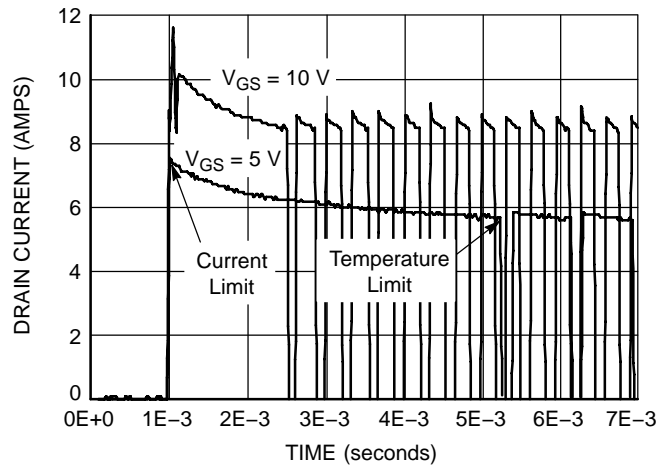

Figure 9. Short Circuit Response*

*(Actual thermal cycling response in short circuit dependent on device power level, thermal mounting, and ambient temperature conditions)

MECHANICAL CASE OUTLINE

PACKAGE DIMENSIONS

ON Semiconductor®

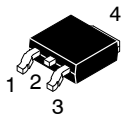

SCALE 1:1

DPAK (SINGLE GAUGE)

CASE 369C

ISSUE F

DATE 21 JUL 2015

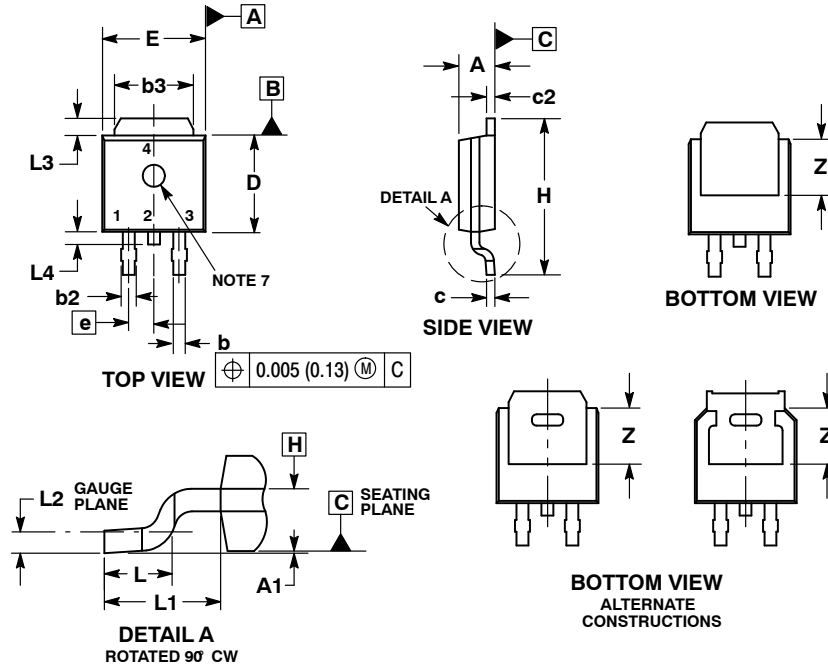

NOTES:

1. DIMENSIONING AND TOLERANCING PER ASME Y14.5M, 1994.
2. CONTROLLING DIMENSION: INCHES.
3. THERMAL PAD CONTOUR OPTIONAL WITHIN DIMENSIONS b3, L3 and Z.
4. DIMENSIONS D AND E DO NOT INCLUDE MOLD FLASH, PROTRUSIONS, OR BURRS. MOLD FLASH, PROTRUSIONS, OR GATE BURRS SHALL NOT EXCEED 0.006 INCHES PER SIDE.
5. DIMENSIONS D AND E ARE DETERMINED AT THE OUTERMOST EXTREMES OF THE PLASTIC BODY.
6. DATUMS A AND B ARE DETERMINED AT DATUM PLANE H.
7. OPTIONAL MOLD FEATURE.

DIM	INCHES		MILLIMETERS	
	MIN	MAX	MIN	MAX
A	0.086	0.094	2.18	2.38
A1	0.000	0.005	0.00	0.13
b	0.025	0.035	0.63	0.89
b2	0.028	0.045	0.72	1.14
b3	0.180	0.215	4.57	5.46
c	0.018	0.024	0.46	0.61
c2	0.018	0.024	0.46	0.61
D	0.235	0.245	5.97	6.22
E	0.250	0.265	6.35	6.73
e	0.090 BSC		2.29 BSC	
H	0.370	0.410	9.40	10.41
L	0.055	0.070	1.40	1.78
L1	0.114 REF		2.90 REF	
L2	0.020 BSC		0.51 BSC	
L3	0.035	0.050	0.89	1.27
L4	---	0.040	---	1.01
Z	0.155	---	3.93	---

GENERIC MARKING DIAGRAM*

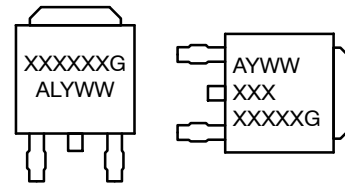

IC

Discrete

- XXXXXX = Device Code
- A = Assembly Location
- L = Wafer Lot
- Y = Year
- WW = Work Week
- G = Pb-Free Package

*This information is generic. Please refer to device data sheet for actual part marking.

- | | | | | |
|--|--|---|---|--|
| <p>STYLE 1:
PIN 1. BASE
2. COLLECTOR
3. EMITTER
4. COLLECTOR</p> | <p>STYLE 2:
PIN 1. GATE
2. DRAIN
3. SOURCE
4. DRAIN</p> | <p>STYLE 3:
PIN 1. ANODE
2. CATHODE
3. ANODE
4. CATHODE</p> | <p>STYLE 4:
PIN 1. CATHODE
2. ANODE
3. GATE
4. ANODE</p> | <p>STYLE 5:
PIN 1. GATE
2. ANODE
3. CATHODE
4. ANODE</p> |
| <p>STYLE 6:
PIN 1. MT1
2. MT2
3. GATE
4. MT2</p> | <p>STYLE 7:
PIN 1. GATE
2. COLLECTOR
3. EMITTER
4. COLLECTOR</p> | <p>STYLE 8:
PIN 1. N/C
2. CATHODE
3. ANODE
4. CATHODE</p> | <p>STYLE 9:
PIN 1. ANODE
2. CATHODE
3. RESISTOR ADJUST
4. CATHODE</p> | <p>STYLE 10:
PIN 1. CATHODE
2. ANODE
3. CATHODE
4. ANODE</p> |

SOLDERING FOOTPRINT*

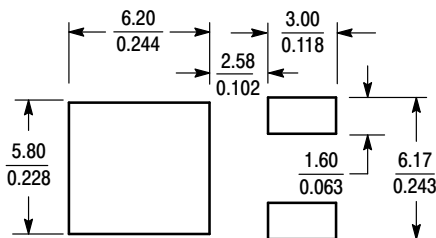

SCALE 3:1 (mm / inches)

*For additional information on our Pb-Free strategy and soldering details, please download the ON Semiconductor Soldering and Mounting Techniques Reference Manual, SOLDERRM/D.

DOCUMENT NUMBER:	98AON10527D	Electronic versions are uncontrolled except when accessed directly from the Document Repository. Printed versions are uncontrolled except when stamped "CONTROLLED COPY" in red.
DESCRIPTION:	DPAK (SINGLE GAUGE)	PAGE 1 OF 1

ON Semiconductor and ON are trademarks of Semiconductor Components Industries, LLC dba ON Semiconductor or its subsidiaries in the United States and/or other countries. ON Semiconductor reserves the right to make changes without further notice to any products herein. ON Semiconductor makes no warranty, representation or guarantee regarding the suitability of its products for any particular purpose, nor does ON Semiconductor assume any liability arising out of the application or use of any product or circuit, and specifically disclaims any and all liability, including without limitation special, consequential or incidental damages. ON Semiconductor does not convey any license under its patent rights nor the rights of others.

onsemi, **Onsemi**, and other names, marks, and brands are registered and/or common law trademarks of Semiconductor Components Industries, LLC dba "**onsemi**" or its affiliates and/or subsidiaries in the United States and/or other countries. **onsemi** owns the rights to a number of patents, trademarks, copyrights, trade secrets, and other intellectual property. A listing of **onsemi**'s product/patent coverage may be accessed at www.onsemi.com/site/pdf/Patent-Marking.pdf. **onsemi** reserves the right to make changes at any time to any products or information herein, without notice. The information herein is provided "as-is" and **onsemi** makes no warranty, representation or guarantee regarding the accuracy of the information, product features, availability, functionality, or suitability of its products for any particular purpose, nor does **onsemi** assume any liability arising out of the application or use of any product or circuit, and specifically disclaims any and all liability, including without limitation special, consequential or incidental damages. Buyer is responsible for its products and applications using **onsemi** products, including compliance with all laws, regulations and safety requirements or standards, regardless of any support or applications information provided by **onsemi**. "Typical" parameters which may be provided in **onsemi** data sheets and/or specifications can and do vary in different applications and actual performance may vary over time. All operating parameters, including "Typicals" must be validated for each customer application by customer's technical experts. **onsemi** does not convey any license under any of its intellectual property rights nor the rights of others. **onsemi** products are not designed, intended, or authorized for use as a critical component in life support systems or any FDA Class 3 medical devices or medical devices with a same or similar classification in a foreign jurisdiction or any devices intended for implantation in the human body. Should Buyer purchase or use **onsemi** products for any such unintended or unauthorized application, Buyer shall indemnify and hold **onsemi** and its officers, employees, subsidiaries, affiliates, and distributors harmless against all claims, costs, damages, and expenses, and reasonable attorney fees arising out of, directly or indirectly, any claim of personal injury or death associated with such unintended or unauthorized use, even if such claim alleges that **onsemi** was negligent regarding the design or manufacture of the part. **onsemi** is an Equal Opportunity/Affirmative Action Employer. This literature is subject to all applicable copyright laws and is not for resale in any manner.

PUBLICATION ORDERING INFORMATION

LITERATURE FULFILLMENT:

Email Requests to: orderlit@onsemi.com

onsemi Website: www.onsemi.com

TECHNICAL SUPPORT

North American Technical Support:

Voice Mail: 1 800-282-9855 Toll Free USA/Canada

Phone: 011 421 33 790 2910

Europe, Middle East and Africa Technical Support:

Phone: 00421 33 790 2910

For additional information, please contact your local Sales Representative

Mouser Electronics

Authorized Distributor

Click to View Pricing, Inventory, Delivery & Lifecycle Information:

[onsemi:](#)

[NID6002NT4](#) [NID6002NT4G](#)