

## FEATURES

- DOUBLE LAYER CONSTRUCTION
- POWER BACK-UP FOR CMOS DEVICES
- SURFACE MOUNTABLE V-CHIP STYLE
- LEAD-FREE FINISH

**RoHS Compliant**  
**High Temperature Reflow**  
**+260°C**

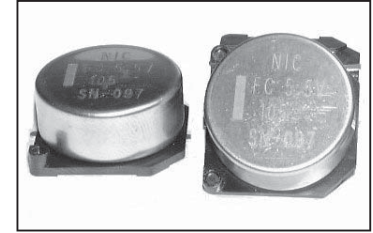

## CHARACTERISTICS

Rated Voltage Range	3.5 & 5.5VDC	
Rated Capacitance Range	0.047F ~ 0.47F (47,000μF ~ 470,000μF)	
Operating Temp. Range	-40°C ~ +85°C	
Capacitance Tolerance	+80%/-20% (Z)	
Load Life Test +85°C 240 hours	Δ Capacitance Change	Within ±30% of initial measured value
	Maximum ESR	Less than 200% of the specified maximum value
	Current at 30 minutes	Less than 200% of the specified maximum value
Temperature Cycling (5 cycles, -25 ~ +70°C)	Δ Capacitance Change	Within +80%/-20% of specified value
	Maximum ESR	Less than specified maximum value
	Current at 30 minutes	Less than specified maximum value
Humidity Resistance (240 hours @ 40°C/90% RH)	Δ Capacitance Change	Within ±20% of initial measured value
	Maximum ESR	Less than 120% of the specified maximum value
	Current at 30 minutes	Less than 120% of the specified maximum value

Super Capacitor  
Application Guide

## STANDARD VALUES AND SPECIFICATIONS

NIC P/N	Capacitance Value (F) Discharge	Working Voltage (VDC)	Max. Current @ 30 minutes (mA)	Max. ESR @ 1KHz (Ω)
NEXCW104Z3.5V10.7X5.5TRF	0.10	3.5	0.090	100
NEXCW224Z3.5V10.7X5.5TRF	0.22	3.5	0.200	50
NEXCW474Z3.5V10.7X8.5TRF	0.47	3.5	0.420	50
NEXCW473Z5.5V10.7X5.5TRF	0.047	5.5	0.071	100
NEXCW104Z5.5V10.7X5.5TRF	0.10	5.5	0.150	50
NEXCW224Z5.5V10.7X8.5TRF	0.22	5.5	0.330	50

## HIGH TEMPERATURE REFLOW PROFILE

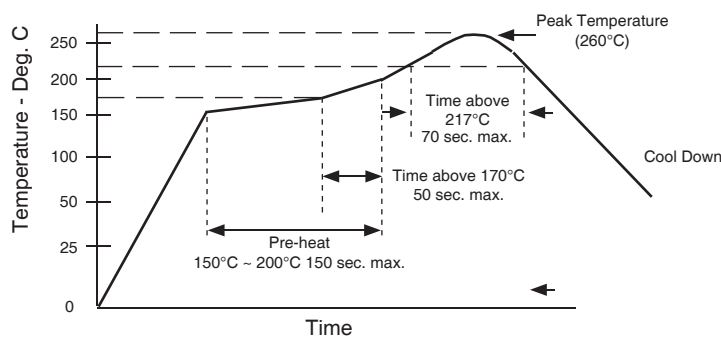

Peak Temperature	+260°C
Time above +255°C	10 sec. max.
Time above +230°C	45 sec. max.
Time above +220°C	60 sec. max.
Time above +217°C	70 sec. max.
150°C ~ +200°C (with time above +170°C 50 sec. max.)	150 sec. max.

1. The temperatures shown are the surface temperature values on the top of the can and on the capacitor terminals.
2. 2x reflow process maximum. Capacitor should be allowed to return to room temperature before second reflow process.

## PRECAUTIONS

WASHING is NOT RECOMMENDED. Additional precautions can be found at [www.niccomp.com/precautions](http://www.niccomp.com/precautions)  
 If in doubt or uncertainty, please review your specific application - process details with NIC's technical support personnel: [tpmg@niccomp.com](mailto:tpmg@niccomp.com)



### CASE DIMENSIONS (mm)

Case Size	$D\phi \pm$	L max.	A/B $\pm 0.2$	I	W	P
10.7 x 5.5	10.7	5.5	10.8	$3.9 \pm 0.5$	$1.2 \pm 0.1$	5.0
10.7 x 8.5	10.7	8.5	10.8	$3.9 \pm 0.5$	$1.2 \pm 0.1$	5.0

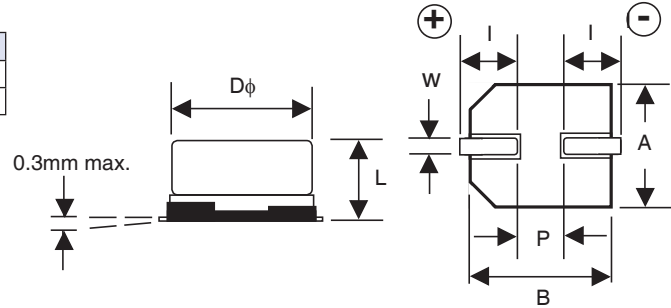

### LAND PATTERN DIMENSIONS (mm)

Case Diameter	R	S	T
10.7	5.0	4.9	2.5

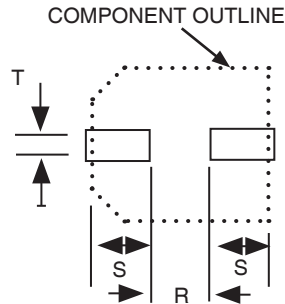

### CARRIER TAPE DIMENSIONS (mm)

Case Size	A	B	D	E	F	P	$P_1$	$T_1$	$T_2$	W	Quantity/Reel
10.7 x 5.5	11.4	13.0	1.55	1.75	11.5	4.0	16.0	0.4	6.0	24.0	1,000
10.7 x 8.5	11.4	13.0	1.55	1.75	11.5	4.0	16.0	0.4	8.4	24.0	500

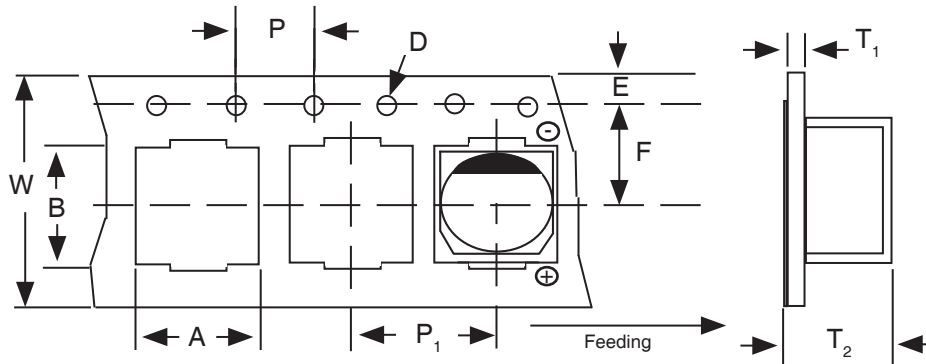

### REEL DIMENSIONS (mm)

Case Size	$A \pm 2.0$	$B \pm 1.0$	$C \pm 0.5$	$D \pm 0.8$	$E \pm 0.5$	W	t
10.7 x 5.5	380	80.0	13.0	21.0	2.0	$25.5 \pm 0.5$	2.0
10.7 x 8.5	380	100.0	13.0	21.0	2.0	$25.5 \pm 1.0$	2.0

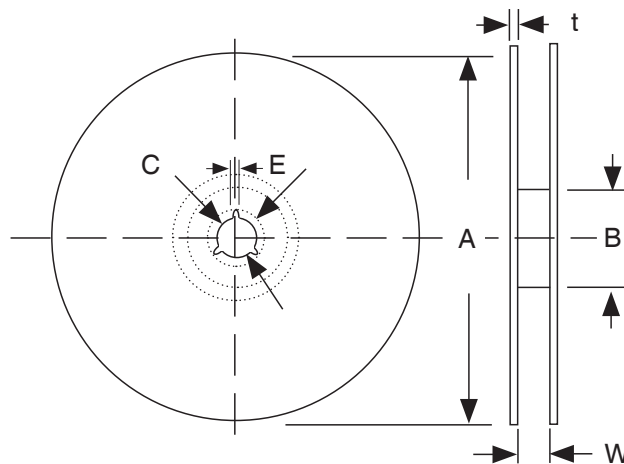

### HIGH TEMPERATURE REFLOW PROFILE

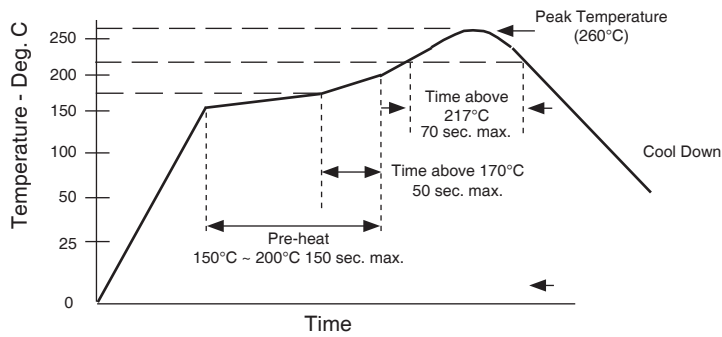

Peak Temperature	+260°C
Time above +255°C	10 sec. max.
Time above +230°C	45 sec. max.
Time above +220°C	60 sec. max.
Time above +217°C	70 sec. max.
150°C ~ +200°C (with time above +170°C 50 sec. max.)	150 sec. max.

1. The temperatures shown are the surface temperature values on the top of the can and on the capacitor terminals.
2. 2x reflow process maximum. Capacitor should be allowed to return to room temperature before second reflow process.

### LAND PATTERN DIMENSIONS (mm)

Case Diameter	R	S	T
10.7	5.0	4.9	2.5

### COMPONENT OUTLINE

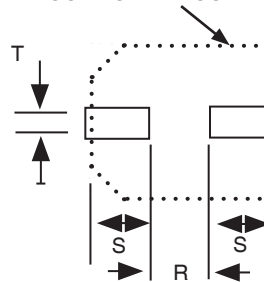

### CARRIER TAPE DIMENSIONS (mm)

Case Size	A	B	D	E	F	G	P	P <sub>1</sub>	T <sub>1</sub>	T <sub>2</sub>	W	Quantity/Reel
10.7 x 5.5	11.4	13.0	1.55	1.75	11.5	-	4.0	16.0	0.4	6.0	24.0	1,000

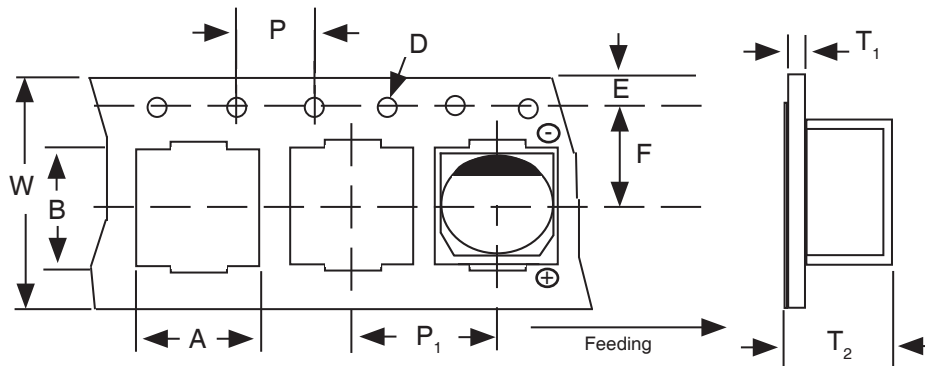

### REEL DIMENSIONS (mm)

Case Size	A ± 2.0	B ± 1.0	C ± 0.5	D ± 0.8	E ± 0.5	W	t
10.7 x 5.5	380	80.0	13.0	21.0	2.0	25.5	3.0

