

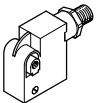



Proximity sensors, block design



Proximity sensors, block design

Product range overview

Measuring principle	Version	Type	Installation	Switching element function		Switching output	Electrical connection	
				N/O contact	N/C contact		Cable	Plug connector
Magneto-inductive	Operating voltage range 10 ... 30 V DC							
		SMT0-1	Via accessories	■	-	PNP	3-wire	M8x1, 3-pin
				■	-	NPN	3-wire	M8x1, 3-pin
	SMTSO-1 Welding field resistant		■	-	PNP	-	M12x1, 3-pin	
Magnetic reed	Operating voltage range 0 ... 30 V DC							
		SMEO-1	Via accessories	■	-	Contacting	-	M8x1, 3-pin ¹⁾
				■	-		3-wire	M8x1, 3-pin
	Operating voltage range 0 ... 250 V AC, 0 ... 200 V DC							
		SMEO-1-B	Via accessories	■	-	Contacting	2-wire	-
		SMEO-1		■	-		2-wire	-
				■	-		2-wire	-
	SMEO-1-S6-C Heat resistant up to 120°C	■		-	2-wire		-	
Magnetic	Pneumatic proximity sensor, operating pressure 2 ... 6 bar							
	SMPO-1	Via accessories	■ ²⁾	-	-	-	-	
Magneto-inductive	Operating voltage range 10 ... 30 V DC							
		SMT-C1	Clamped	■	-	PNP	3-wire	M8x1, 3-pin M12x1, 3-pin

1) The proximity sensor has 2 wires internally. One pin of the M8 plug connector is unused.

2) 3/2-way valve, normally closed

Proximity sensors, block design

Product range overview

Type	Outlet direction of connection		Replacement without re-adjustment	Switching status display via LED	Free of copper and PTFE	→ Page/Internet
	In-line	Lateral				
Operating voltage range 10 ... 30 V DC						
SMTO-1	■	–	■ 1)	■	■	7
	■	–	■ 1)	■	–	
SMTSO-1 Welding field resistant	■	–	–	■	–	10
Operating voltage range 0 ... 30 V DC						
SMEO-1	■	–	■ 1)	–	■	12
	■	–	■ 1)	■	■	
Operating voltage range 0 ... 250 V DC, 0 ... 200 V DC						
SMEO-1-B	■	–	■ 1)	–	–	12
SMEO-1	■	–	■ 1)	■	–	
	■	–	■ 1)	–	–	
SMEO-1-S6-C Heat resistant up to 120°C	■	–	■ 1)	■	–	
Pneumatic proximity sensor, operating pressure 2 ... 6 bar						
SMPO-1	■	–	■ 1)	– 2)	–	17
Operating voltage range 10 ... 30 V DC						
SMT-C1	■	–	–	■	■	19

1) Not in combination with mounting kit SMB-1 or SMBS-...

2) Switching status is indicated by means of a plunger

Proximity sensors, block design

Peripherals overview

FESTO

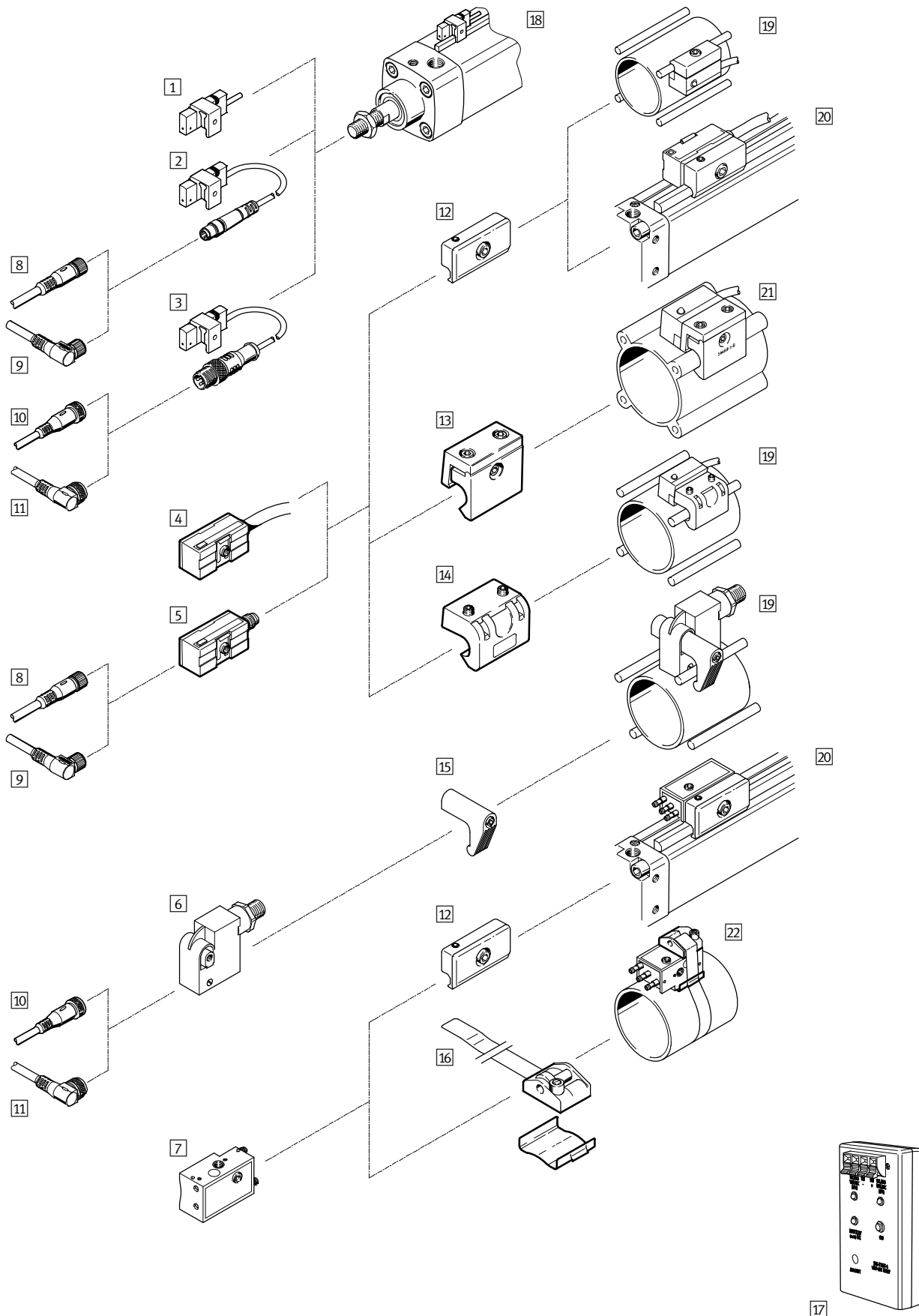

Proximity sensors, block design

Peripherals overview

FESTO

Mounting components and accessories			
	Brief description	→ Page/Internet	
Proximity sensor			
1	SMT-C1-...	Magneto-inductive, with cable and clamping component	19
2	SMT-C1-...	Magneto-inductive, with cable and plug connector M8x1 and clamping component	19
3	SMT-C1-...	Magneto-inductive, with cable and plug connector M12x1 and clamping component	19
4	SMT0-1-...	Magneto-resistive, with cable	7
	SME0-1-...	Magnetic reed, with cable	12
5	SMT0-1-...	Magneto-resistive, with plug connector M8x1	7
	SME0-1-...	Magnetic reed, with plug connector M8x1	12
6	SMTSO-1-...	Magneto-resistive, welding field resistant, with plug connector M12x1	10
7	SMPO-1-...	Pneumatic	17
Accessories			
8	Connecting cable NEBU-M8G3-...	Straight socket, M8x1, 3-pin	24
9	Connecting cable NEBU-M8W3-...	Angled socket, M8x1, 3-pin	
10	Connecting cable NEBU-M12G5-...	Straight socket, M12x1, 3-pin	
11	Connecting cable NEBU-M12W5-...	Angled socket, M12x1, 3-pin	
12	Mounting kit SMB-1	For drives with tie rod \varnothing 6 mm or mounting rail For ISO cylinders DSBG	22
13	Mounting kit SMBU-1-B	For ISO cylinders DNU	22
14	Mounting kits SMB-2-B, SMB-3-B	For ISO cylinders DSBG	22
15	Mounting kit SMBT-1	For ISO cylinders DSBG	23
16	Mounting kit SMBS-...	For round cylinders	23
17	Sensor tester SM-TEST-1	-	sm-test-1
Drives			
18	ISO cylinder DSBF-C or CDN-...-R with sensor rail	\varnothing 32 ... 100 mm	-
19	ISO cylinder DSBG	\varnothing 32 ... 125 mm	-
20	Flat cylinder DZH	\varnothing 32 ... 63 mm	-
	Semi-rotary drive DRQ	\varnothing 40 ... 100 mm	
21	ISO cylinder DNU	\varnothing 32 ... 125 mm	
22	Round cylinder	\varnothing 8 ... 100 mm	

Proximity sensors, block design

Type codes

Proximity sensors for cylinders with tie or mounting rod

		SMT0-1	-	PS	-	K	-	LED	-	24	-	C
Function												
SMT0-1	Proximity sensor, block design, magneto-resistive											
SMTSO-1	Proximity sensor, block design, magneto-resistive, welding field resistant											
SME0-1	Proximity sensor, block design, magnetic reed											
SMPO-1	Proximity sensor, block design, magnetic											
Switching output, switching element function												
PS	PNP, N/O contact, 3-wire											
NS	NPN, N/O contact, 3-wire											
	N/O contact, 2- or 3-wire											
Electrical connection, cable length												
K	Cable, 2.5 m											
S	Plug connector M8x1											
Switching status display												
LED	Yellow LED											
Rated operating voltage												
24	24 V DC											
230	230 V AC											
Generation												
B	B series											
C	C series											

Proximity sensors for ISO cylinders DSBF-C or CDN...-R with sensor strip

		SMT-C1	-	PS	-	24 V	-	K	-	5,0	-	OE
Function												
SMT-C1	Proximity sensor, block design, magneto-inductive											
Switching element function, switching output												
PS	N/O contact, 3-wire, PNP											
Rated operating voltage												
24V	24 V DC											
Version												
K	Cable											
Cable length												
0,3	0.3 m											
5,0	5.0 m											
10,0	10.0 m											
Electrical connection												
OE	Open end											
M8D	Cable with plug connector M8x1, rotatable thread											
M12	Cable with plug connector M12x1											

Proximity sensors SMTO-1, block design, magneto-inductive

Technical data

Function

e.g. PNP, N/O contact, with cable

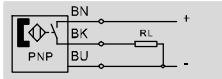

e.g. NPN, N/O contact, with cable

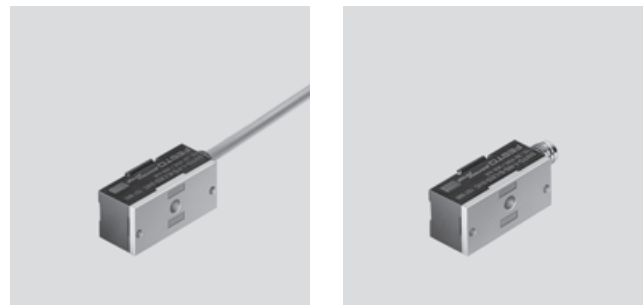

Design	
Design	Block design
Type of mounting	Via accessories
Max. tightening torque [Nm]	0.3
Outlet direction of connection	In-line
Switching status display	Yellow LED
Reproducibility of switching point ¹⁾ [mm]	±0.1

1) Only applicable to drives secured against rotation.

Technical data		SMTO-...-K-...	SMTO-...-S-...
Switching output		PNP NPN	
Switching element function		N/O contact	
Measuring principle		Magneto-inductive	
Operating voltage range [V DC]		10 ... 30	
Max. output current [mA]		200	
Max. switching capacity [W]		6	
Voltage drop [V]		≤3	
Residual current [mA]		≤0.01	
Switch-on time [ms]		≤1	
Switch-off time [ms]		≤1	
Short circuit protection		Yes	Pulsed
Overload protection		Yes	
Reverse polarity protection		For all electrical connections	
Cable property		Standard	-
Degree of protection		IP67	

Operating and environmental conditions		SMTO-...-K-...	SMTO-...-S-...
Variant			
Ambient temperature [°C]		-25 ... +70	
Ambient temperature with flexible cable installation [°C]		-5 ... +70	-
Certification		RCM	
CE marking (see declaration of conformity)		In accordance with EU EMC Directive ¹⁾	

1) For information about the applicability of the component see the manufacturer's EC declaration of conformity at: www.festo.com/sp → User documentation.
If the component is subject to restrictions on usage in residential, office or commercial environments or small businesses, further measures to reduce the emitted interference may be necessary.

Proximity sensors SMTO-1, block design, magneto-inductive

Technical data

Materials		
Variant	SMTO-...-K-...	SMTO-...-S-...
Housing	PET, die-cast zinc	PET, PC, POM, PUR, steel, die-cast zinc
Cable sheath	PVC	-
Note on materials	Free of copper and PTFE	

Dimensions Download CAD data → www.festo.com

SMTO-1 – Cable

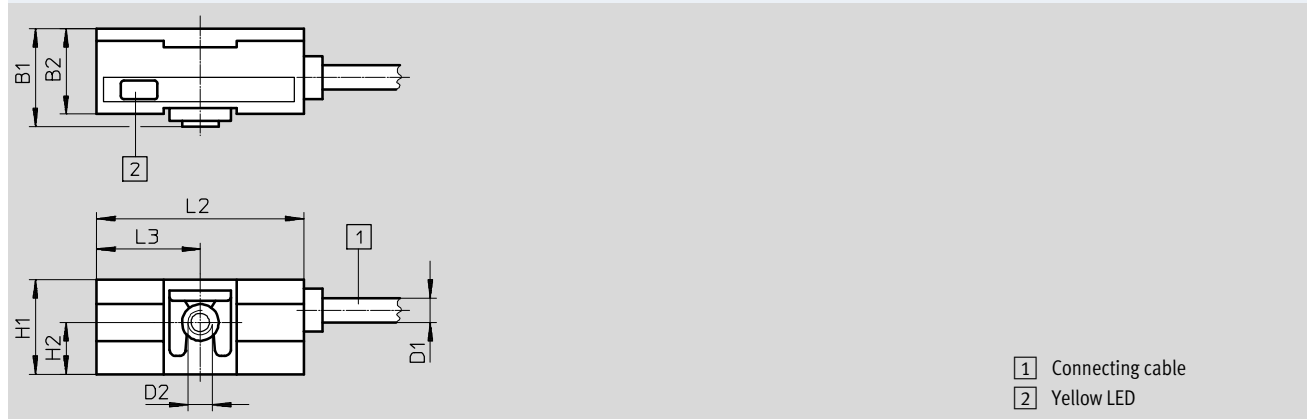

	B1	B2	D1	D2	H1	H2	L2	L3
	-0.2	±0.3	∅		±0.2	±0.1	±0.2	-0.1
SMTO-1- ... SK-LED-24-C	16	14	4-0.3	M4	15.5	8.5	34	17

Proximity sensors SMT0-1, block design, magneto-inductive

Technical data

Dimensions

Download CAD data → www.festo.com

SMT0-1-S – Plug connector M8x1

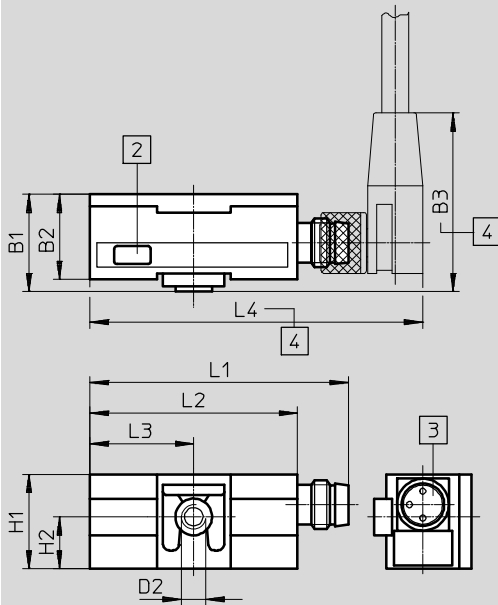

- 2 Yellow LED
- 3 Suitable for socket type SIM-M8
- 4 Installation space for angled plug socket 90°

	B1	B2	B3	D2	H1	H2	L1	L2	L3	L4
	-0.2	±0.3			±0.2	±0.1		±0.2	-0.1	
SMT0-1-...S-S-LED-24-C	16	14	~27.5	M4	15.5	8.5	42.3±0.3	34	17	~54.5

Ordering data

	Switching output	Electrical connection		Cable length [m]	Product weight [g]	Part No.	Type
		Cable	Plug connector M8x1				
	N/O contact						
	PNP	3-wire	–	2.5	85	151683	SMT0-1-PS-K-LED-24-C
		–	3-pin	–	20	151685	SMT0-1-PS-S-LED-24-C
	NPN	3-wire	–	2.5	85	151684	SMT0-1-NS-K-LED-24-C
–		3-pin	–	20	151686	SMT0-1-NS-S-LED-24-C	

Proximity sensors SMTSO-1, block design, magneto-inductive

Technical data

Function

PNP, N/O contact, with plug connector



- Welding field resistant
- Magneto-inductive measuring principle



Design	
Design	Block design
Type of mounting	Via accessories
Tightening torque [Nm]	<0.3
Outlet direction of connection	In-line
Switching status display	Yellow LED
Ready status display	Green LED
Reproducibility of switching point ¹⁾ [mm]	±0.1

1) Only applicable to drives secured against rotation.

Technical data – PNP, N/O contact	
Switching output	PNP
Switching element function	N/O contact
Measuring principle	Magneto-inductive
Electrical connection	Plug connector M12x1, 3-pin
Operating voltage range [V DC]	10 ... 30
Max. output current [mA]	200
Max. switching capacity DC [W]	6
Voltage drop [V]	3
Residual current [mA]	0.01
Switch-on time [ms]	≤35
Switch-off time [ms]	≤20
Resistance to interference from magnetic fields	Alternating magnetic field 50 ... 60 Hz
Short circuit protection	Pulsed
Overload protection	Yes
Reverse polarity protection	For all electrical connections
Degree of protection	IP67

Operating and environmental conditions	
Ambient temperature [°C]	-25 ... +70
CE marking (see declaration of conformity)	To EU EMC Directive ¹⁾
Certification	RCM

1) For information about the applicability of the component see the manufacturer's EC declaration of conformity at: www.festo.com/sp → User documentation.
If the component is subject to restrictions on usage in residential, office or commercial environments or small businesses, further measures to reduce the emitted interference may be necessary.

Proximity sensors SMTSO-1, block design, magneto-inductive

Technical data

Materials	
Housing	PA, PUR, die-cast zinc
Note on materials	Free of copper and PTFE

Dimensions Download CAD data → www.festo.com
 Plug connector M12x1

- 1 Ready status display, green LED
- 2 Switching status, yellow LED
- 3 Mounting kit SMBT-1
- 4 Installation space for plug socket
- 5 Identification of theoretical switching point

	B1	B2	D1	D2	H1	H2	H3	L1	L2	L3	L4	L5	L6
	±0.25	+0.8			±0.3	±0.25	±0.2	±0.6	±0.3		±0.2	±0.3	
SMTSO-1-PS-S-LED-24	22	16.6	M12x1	M4	34	25	22	55	34	10	7.5	11	~85

Ordering data					
	Switching output	Electrical connection	Product weight [g]	Part No.	Type
	N/O contact				
	Welding field resistant				
	PNP	Plug connector M12x1, 3-pin	70	30441	SMTSO-1-PS-S-LED-24

Ordering data – Connecting cables					
	Switching output	Cable length [m]	Weight [g]	Part No.	Type
Resistant to welding spatter					
	3-wire, M12x1 socket, straight	3	–	30450	SIM-M12-RS-3GD-3
	3-wire, M12x1 socket, angled	3	–	30451	SIM-M12-RS-3WD-3

Proximity sensors SMEO-1, block design, magnetic reed

Technical data

Function

e.g. N/O contact, 3-wire, with cable

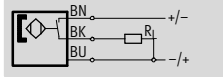

- Magnetic reed measuring principle

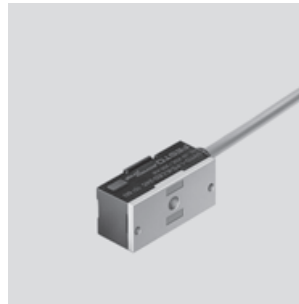

e.g. N/O contact, 3-wire, with plug connector

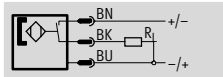

General technical data					
Electrical connection	3-wire		2-wire		
Type	SMEO-1-...-24	SMEO-1-S-24-B	SMEO-1-LED-230	SMEO-1-B	SMEO-1-S6 heat resistant
Design	Block design				
Conforms to standard	-	-	EN 60947-5-2	DIN EN 60947-5-2	DIN EN 60947-5-2
Certification	RCM	-	RCM	-	-
CE marking (see declaration of conformity)	To EU EMC Directive	-	To EU EMC Directive	-	-
Note on materials	Free of copper and PTFE				

1) For information about the applicability of the component see the manufacturer's EC declaration of conformity at: www.festo.com/sp → User documentation.
If the component is subject to restrictions on usage in residential, office or commercial environments or small businesses, further measures to reduce the emitted interference may be necessary.

Input signal/measuring element		
Type	SMEO-1	SMEO-1-S6 heat resistant
Measuring principle	Magnetic reed	Magnetic reed
Ambient temperature [°C]	-20 ... +70	-50 ... +120

Switching output					
Electrical connection	3-wire		2-wire		
Type	SMEO-1-...-24	SMEO-1-S-24-B	SMEO-1-LED-230	SMEO-1-B	SMEO-1-S6 heat resistant
Switching output	Contacting, bipolar				
Switching element function	N/O contact				
Reproducibility of switching point ¹⁾ [mm]	±0.1				
Switch-on time [ms]	≤0.5		0.5		
Switch-off time [ms]	-		0.03		
Max. switching frequency [Hz]	-		500		
Max. output current [mA]	1000	-	-	1000	1000
Max. output current DC [mA]	-	-	120	-	-
Max. output current AC [mA]	-	-	250	-	-
Max. switching capacity DC [W]	27		40		
Max. switching capacity AC [VA]	27		40		
Voltage drop [V]	-		≤4.5	0	
Residual current [mA]	-		0		

1) Only applicable to drives secured against rotation.

Output, additional data	
Short circuit protection	No
Overload protection	Not present

Proximity sensors SMEO-1, block design, magnetic reed

Technical data

Electronics					
Electrical connection	3-wire		2-wire		
Type	SMEO-1-...-24	SMEO-1-S-24-B	SMEO-1-LED-230	SMEO-1-B	SMEO-1-S6 heat resistant
Operating voltage range DC [V]	12 ... 27	0 ... 30	5 ... 200	0 ... 200	
Operating voltage range AC [V]	12 ... 27		5 ... 250	0 ... 250	
Reverse polarity protection	No				

Electromechanical components					
Electrical connection	3-wire		2-wire		
Type	SMEO-1-...-24	SMEO-1-S-24-B	SMEO-1-LED-230	SMEO-1-B	SMEO-1-S6 heat resistant
Electrical connection	Cable and plug	Plug M8x1, 3-pins	Cable		
Outlet direction of connection	In-line	–	In-line		
Materials for cable sheath	TPE-U (PUR)	–	PVC	PVC	TPE-S

Mechanical components					
Electrical connection	3-wire		2-wire		
Type	SMEO-1-...-24	SMEO-1-S-24-B	SMEO-1-LED-230	SMEO-1-B	SMEO-1-S6 heat resistant
Type of mounting	Via accessories				
Mounting position	Any				
Tightening torque [Nm]	–		2.9		

Materials		
Housing	–	Epoxy resin
	–	PC
	PET	PET
	–	Steel
	–	TPE-O
	–	Die-cast zinc
	–	Steel

Proximity sensors SMEO-1, block design, magnetic reed

Technical data

Display/operation					
Electrical connection	3-wire		2-wire		
Type	SMEO-1-...-24	SMEO-1-S-24-B	SMEO-1-LED-230	SMEO-1-B	SMEO-1-S6, heat resistant
Switching status display	Yellow LED	-	Yellow LED	-	-

Immissions/emissions					
Electrical connection	3-wire		2-wire		
Type	SMEO-1-...-24	SMEO-1-S-24-B	SMEO-1-LED-230	SMEO-1-B	SMEO-1-S6, heat resistant
Ambient temperature with flexible cable installation [°C]	-5 ... +70	-	-5 ... +70	-5 ... +70	-40 ... +120
Degree of protection	IP67		IP67		
Surge resistance [kV]	-		4		
Degree of contamination	-		3		

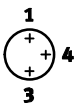
Pin allocation to EN 60947-5-2			
M8x1, 3-pin			
N/O contact			
	Pin	Wire colour	Allocation
	1	Brown	+
	3	Blue	-
	4	Black	Outlet

Proximity sensors SMEO-1, block design, magnetic reed

Technical data

Dimensions

Download CAD data → www.festo.com

SMEO-1 – Cable

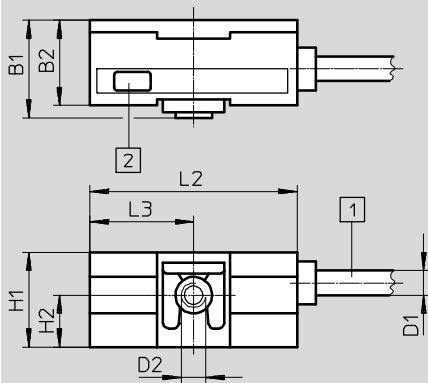

- 1 Connecting cable
- 2 Yellow LED

	B1	B2	D1	D2	H1	H2	L2	L3
	-0.2	±0.3	∅		±0.2	±0.1	±0.2	-0.1
SMEO-1-S6-C	16	14	4.2+0,3	M4	15.5	8.5	34	17
SMEO-1-B								
SMEO-1-LED-24-K5-B								
SMEO-1-LED-230-B								
SMEO-1-LED-230-K5-B								
SMEO-1-LED-24-B								

Dimensions

Download CAD data → www.festo.com

SMEO-1-S – Plug connector M8x1

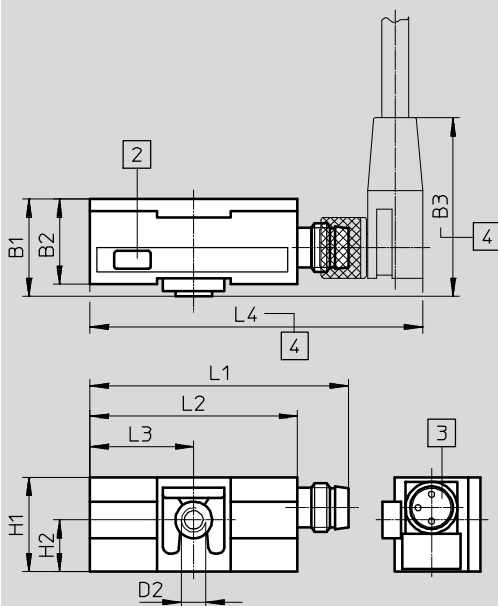

- 2 Yellow LED
- 3 Suitable for socket type SIM-M8
- 4 Installation space for angled plug socket 90°

	B1	B2	B3	D2	H1	H2	L1	L2	L3	L4
	-0.2	±0.3			±0.2	±0.1		±0.2	-0.1	
SMEO-1-S-LED-24-B	16	14	~27.5	M4	15.5	8.5	42±0.2	34	17	~54.5
SMEO-1-S-24-B										

Proximity sensors SMEO-1, block design, magnetic reed

Technical data

Ordering data						
	Electrical connection		Cable length [m]	Switching status display	Product weight [g]	Part No. Type
	Cable	Plug connector M8x1				
	N/O contact					
	Operating voltage range 12 ... 27 V DC					
	3-wire	–	2.5	■	85	30459 SMEO-1-LED-24-B
			5.0	■	130	151672 SMEO-1-LED-24-K5-B
	–	3-pin	–	■	20	150848 SMEO-1-S-LED-24-B
	Operating voltage range 0 ... 30 V DC					
	–	3-pin ¹⁾	–	–	20	150847 SMEO-1-S-24-B
	Operating voltage range 0 ... 250 V AC, 0 ... 200 V DC					
	2-wire	–	2.5	■	100	151671 SMEO-1-LED-230-B
			5.0	■	130	160998 SMEO-1-LED-230-K5-B
			2.5	–	100	30457 SMEO-1-B
	Heat-resistant up to 120 °C					
2-wire	–	2.5	–	100	151673 SMEO-1-S6-C	

1) The proximity sensor has 2 wires internally. One pin of the M8 plug connector is unused.

Proximity sensors SMPO-1, block design, pneumatic

Technical data

Function
3/2-way valve,
normally closed

- Pneumatic proximity sensor
- Magnetic measuring principle

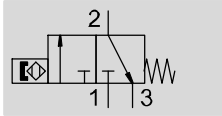

Design	
Design	Block design
Type of mounting	With through-hole Via accessories
Reproducibility of switching point ¹⁾	[mm] ±0.2
Switching status display	Opto-electrical

1) Only applicable to drives secured against rotation.

Technical data	
Switching element function	3/2-way valve, normally closed
Operating medium	Compressed air in accordance with ISO 8573-1:2010 [6:4:4]
Note on operating/pilot medium	Lubricated operation not possible
Operating pressure	[bar] 2 ... 6
Switch-on time	[ms] <30
Switch-off time	[ms] <25
Pneumatic connection	Barbed connector for tubing I.D. 3 mm
Degree of protection	IP65

Operating and environmental conditions	
Ambient temperature	[°C] -15 ... +60

Materials	
Housing	PA, POM
Barbed connector	Brass

Proximity sensors SMPO-1, block design, pneumatic

Technical data

Dimensions Download CAD data → www.festo.com

1 Barbed connector for tubing
I.D. 3 mm

2 Switching status indication

	B1	B2	B3	B4	B5	D2	D3 ∅	H1	H3	H4	H5
	-0.2	±0.2	±0.2	±0.1	±0.1		±0.1	±0.2	±0.2	±0.2	±0.2
SMPO-1-H-B	18	14.2	9	3.8	3.4	M4	2	18	16.7	14.5	12

	H6	H7	H8	H9	H10	L1	L2	L3	L5	L6
	±0.2	±0.1	±0.2	±0.1	±0.1		±0.3	±0.2	±0.2	±0.2
SMPO-1-H-B	8	4	9.3	2	1.6	~40.3	34	17	22	15

Ordering data		Product weight [g]	Part No.	Type
	Pneumatic connection			
	3/2-way valve, normally closed			
	Barbed connector for tubing I.D. 3 mm	14	31008	SMPO-1-H-B

Proximity sensors SMT-C1, block design, inductive

Technical data

Function

PNP, N/O contact, with cable

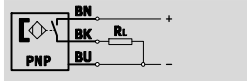

- Magneto-inductive measuring principle
- For ISO cylinders DSBF-C or CDN-...-R with sensor rail



Function

PNP, N/O contact, with plug connector

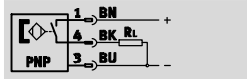

General technical data	
Design	Block design
Based on standard	EN 60947-5-2
Certification	RCM
CE marking (see declaration of conformity)	To EU EMC Directive ¹⁾
Note on materials	Free of copper and PTFE Free of halogen

1) For information about the applicability of the component see the manufacturer's EC declaration of conformity at: www.festo.com/sp → User documentation.
If the component is subject to restrictions on usage in residential, office or commercial environments or small businesses, further measures to reduce the emitted interference may be necessary.

Input signal/measuring element	
Measuring principle	Magneto-inductive
Measured variable	Position
Ambient temperature [°C]	-20 ... +70

Switching output	
Switching output	PNP
Switching element function	N/O contact
Switch-on time [ms]	0 ... 0.5
Switch-off time [ms]	0 ... 0.5
Max. output current [mA]	200
Max. switching capacity DC [W]	6
Voltage drop [V]	0 ... 1.8

Output, additional data	
Short circuit protection	Pulsed
Overload protection	Yes

Proximity sensors SMT-C1, block design, inductive

Technical data

Electronics		
Operating voltage range DC	[V]	10 ... 30
Residual ripple	[%]	10
Reverse polarity protection		For all electrical connections

Electromechanical components			
Type	SMT-C1-...-OE	SMT-C1-...-M8D	SMT-C1-...-M12
Electrical connection	Cable, 3-wire	Cable with plug connector M8x1, 3-pin, rotatable thread	Cable with plug connector M12x1, 3-pin
Outlet direction of connection	In-line		
Cable length	[m]	-	0.3
		5	-
		10	-
Information on materials: cable sheath	TPE-O		
Wire ends	Wire end sleeve		

Mechanical components	
Type of mounting	Clamped
Tightening torque	[Nm] 1.2
Mounting position	Any
Information on materials - housing	High-alloy stainless steel
	Wrought aluminium alloy
	Nickel-plated brass
	PP
	TPE-O
	TPE-U(PU)

Display/operation	
Switching status indication	Yellow LED

Immissions/emissions	
Ambient temperature with flexible cable installation	[°C] -20 ... +70
Degree of protection	To IEC 60529
	IP65
	IP68

Proximity sensors SMT-C1, block design, inductive

Technical data

Pin allocation to EN 60947-5-2				M12x1, 3-pin			
M8x1, 3-pin				N/O contact			
	Pin	Wire colour	Allocation		Pin	Wire colour	Allocation
	1	Brown	+		1	Brown	+
	3	Blue	-		3	Blue	-
	4	Black	Output		4	Black	Output

Dimensions Download CAD data → www.festo.com

- 1 Example: plug connector M8
- 2 Yellow LED
- 3 Theoretical switching point
- 4 Mounting rail on the drive

	B1	B2	B3	D1	H1	H2	H3	H4	H5	L1	L2	L3	L4	L5	L6	L7	⌀
SMT-C1	16	3.5	8.8	3	17	9.2	4	4	3.8	34	26	14.5	13	10	3.5	3	5.5

Ordering data								
	Switching output	Electrical connection			Cable length [m]	Weight [g]	Part No.	Type
		Cable	Cable with plug connector					
				M8x1, rotatable thread	M12x1 connection			
	N/O contact	3-wire	-	-	5	65.9	571339	SMT-C1-PS-24V-K-5,0-OE
	PNP		-	-	10	114.5	571340	SMT-C1-PS-24V-K-10,0-OE
		-	3-pin	-	0.3	24.4	571342	SMT-C1-PS-24V-K-0,3-M8D
		-	-	3-pin	0.3	32.6	571341	SMT-C1-PS-24V-K-0,3-M12

Proximity sensors, block design

Accessories

FESTO

Mounting kit SMB-1

Materials:
Die-cast zinc

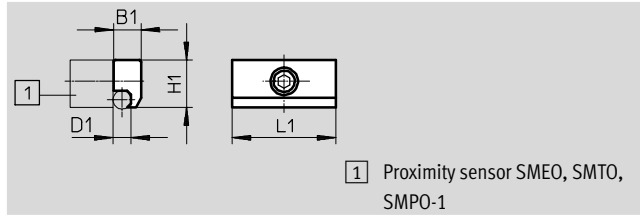

1) Proximity sensor SMEO, SMT0, SMPO-1

Dimensions and ordering data						
For piston \varnothing	B1	D1 \varnothing	H1	L1	Part No.	Type
32 ... 100	9	6	15.5	34	11886	SMB-1

Mounting kit SMB-2-B/SMB-3-B

Materials:
Die-cast aluminium

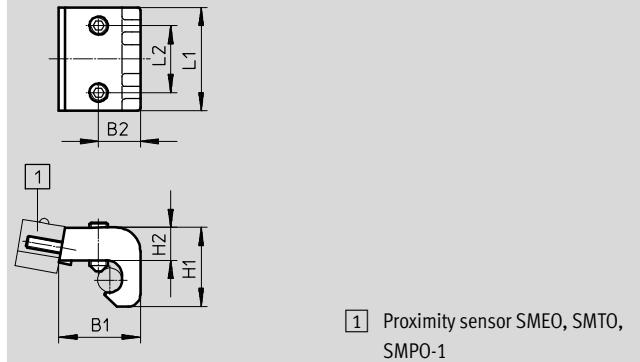

1) Proximity sensor SMEO, SMT0, SMPO-1

Dimensions and ordering data							
For piston \varnothing	B1	B2	H1	H2	L1	L2	Part No. Type
32 ... 50	18	11	23	11.6	34	22	36162 SMB-2-B
63 ... 100	26.8	13.7	26	10.8	34	22	36163 SMB-3-B

Mounting kit SMBU

Materials:
Die-cast aluminium

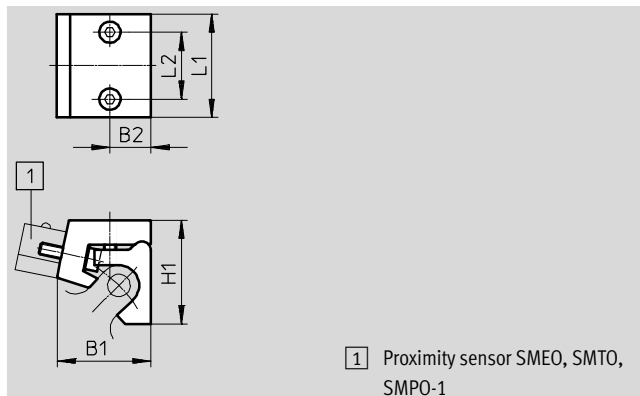

1) Proximity sensor SMEO, SMT0, SMPO-1

Dimensions and ordering data						
For piston \varnothing	B1	B2	H1	L1	L2	Part No. Type
32 ... 50	19	8.5	30	34	22	36173 SMBU-1-B ¹⁾
63 ... 100	31	13.5	34	34	22	36174 SMBU-2-B ¹⁾
125	31	13.5	37	34	22	152828 SMBU-3-B

1) Free of copper and PTFE

Proximity sensors, block design

Accessories

Mounting kit SMBS

Materials:
Brass, polymer

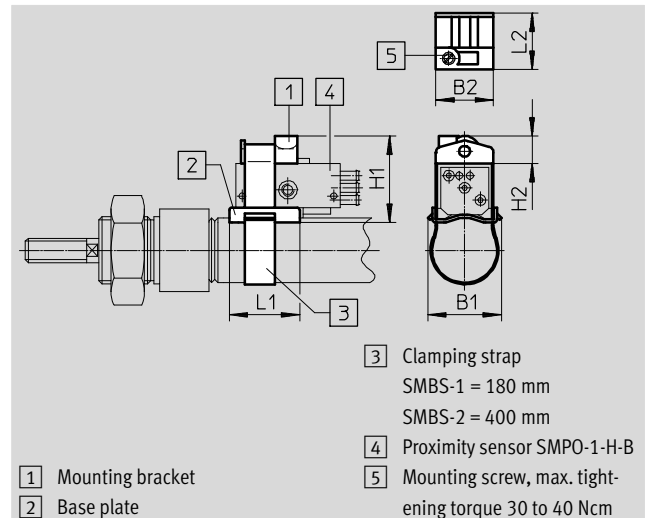

Dimensions and ordering data							
For piston \varnothing	B1	B2	H1	H2	L1	L2	Part No. Type
8 ... 25	24.2	19	~29	9	23	18.5	151225 SMBS-1
32 ... 100							151226 SMBS-2

Mounting kit SMBT-1

Materials:
Die-cast zinc

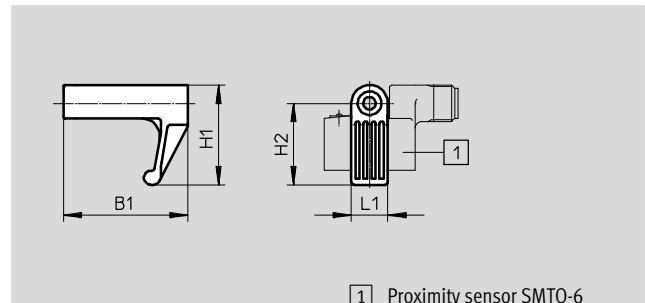





Dimensions and ordering data						
For piston \varnothing	B1	H1	H2	L1	Part No.	Type
	± 0.3		± 0.2	± 0.2		
32 ... 200	41	33	27	12	150002	SMBT-1

Proximity sensors, block design

Accessories

FESTO

Ordering data – Connecting cables				Technical data → Internet: nebu	
		Number of wires	Cable length [m]	Part No.	Type
Socket M8x1, 3-pin					
	For SMT-C1 and SMT0/SME0-1	3	2.5	541333	NEBU-M8G3-K-2.5-LE3
			5	541334	NEBU-M8G3-K-5-LE3
	For SMT-C1 and SMT0/SME0-1	3	2.5	541338	NEBU-M8W3-K-2.5-LE3
			5	541341	NEBU-M8W3-K-5-LE3
Socket M12x1, 5-pin					
	For SMT-C1 and SMT0-6, SMTSO-1	3	2.5	541363	NEBU-M12G5-K-2.5-LE3
			5	541364	NEBU-M12G5-K-5-LE3
	For SMT-C1 and SMT0-6, SMTSO-1	3	2.5	541367	NEBU-M12W5-K-2.5-LE3
			5	541370	NEBU-M12W5-K-5-LE3

Ordering data – Connecting cables					
	Switching output	Cable length [m]	Weight [g]	Part No.	Type
Resistant to welding spatter					
	3-wire, M12x1 socket, straight	3	–	30450	SIM-M12-RS-3GD-3
	3-wire, M12x1 socket, angled	3	–	30451	SIM-M12-RS-3WD-3

Festo - Your Partner in Automation



1 Festo Inc.
5300 Explorer Drive
Mississauga, ON L4W 5G4
Canada

Festo Customer Interaction Center
Tel: 1 877 463 3786
Fax: 1 877 393 3786
Email: customer.service.ca@festo.com

2 Festo Pneumatic
Av. Ceylán 3,
Col. Tequesquináhuac
54020 Tlalneantla,
Estado de México

Multinational Contact Center
01 800 337 8669
ventas.mexico@festo.com

3 Festo Corporation
1377 Motor Parkway
Suite 310
Islandia, NY 11749

Festo Customer Interaction Center
1 800 993 3786
1 800 963 3786
customer.service.us@festo.com

4 Regional Service Center
7777 Columbia Road
Mason, OH 45040

Connect with us



www.festo.com/socialmedia



www.festo.com

Subject to change