



Heat Shrink Tubing



Primary Product Color: **Black**

Wall Type: **Single Wall**

Expanded Inside Diameter (Min): **1.17 mm [.046 in]**

Recovered Inside Diameter (Max): **.58 mm [.023 in]**

Shrink Ratio: **2:1**

Features

Product Type Features

Product Family	RW-175
Wall Type	Single Wall

Electrical Characteristics

Voltage (Max)	.6 kV
---------------	-------

Body Features

Fluid Type	Anti-Icing Fluid, Aviation Fuel, Cleaning Solvents, Gasoline, Hydraulic Fluid, Lubricating Oil, Water
Primary Product Color	Black
Shrink Ratio	2:1
Primary Product Material	Crosslinked Fluoropolymer
Flexibility	Semi-Rigid

Dimensions

Recovered Wall Thickness (Tolerance)	.11 mm[.004 in]
--------------------------------------	-----------------



Cut Length	1220 mm[48.031 in]
------------	--------------------

Recovered Wall Thickness (Nominal)	.25 mm[.01 in]
------------------------------------	----------------

Expanded Inside Diameter (Min)	1.17 mm[.046 in]
--------------------------------	------------------

Recovered Inside Diameter (Max)	.58 mm[.023 in]
---------------------------------	-----------------

Usage Conditions

Shrink Temperature (Min)	155 °C
--------------------------	--------

Fluid Resistance	Splash Protection
------------------	-------------------

Heat Shrink Tubing Flammability	Highly Flame-Retardant
---------------------------------	------------------------

Operating Temperature Range	-55 – 175 °C
-----------------------------	--------------

Heat Shrink Tubing Resistance	Abrasion, Cut-Through, Fluids, Mechanical Damage, Strain Relief
-------------------------------	-----------------------------------------------------------------

Recovery Temperature	175 °C
----------------------	--------

Product Availability

Applicable Region	Global
-------------------	--------

Packaging Features

Packaging Method	Stick
------------------	-------

Other

Meets Low Outgassing Requirements	Yes
-----------------------------------	-----

Product Source	Czech Republic
----------------	----------------

Product Compliance

[For compliance documentation, visit the product page on TE.com>](#)

EU RoHS Directive 2011/65/EU	Compliant
------------------------------	-----------

EU ELV Directive 2000/53/EC	Compliant
-----------------------------	-----------

China RoHS 2 Directive MIIT Order No 32, 2016	No Restricted Materials Above Threshold
-----------------------------------------------	-----------------------------------------

EU REACH Regulation (EC) No. 1907/2006	Current ECHA Candidate List: JAN 2023 (233) Candidate List Declared Against: JAN 2022 (223) Does not contain REACH SVHC
----------------------------------------	-------------------------------------------------------------------------------------------------------------------------------















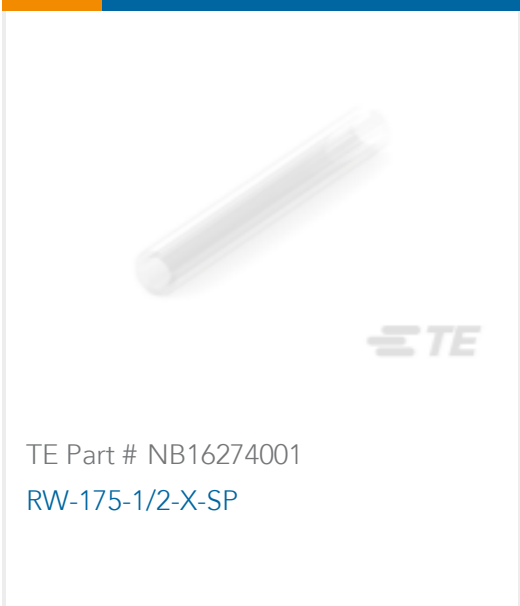

Halogen Content	Not Low Halogen - contains Br or Cl > 900 ppm.
-----------------	------------------------------------------------

Solder Process Capability	Not applicable for solder process capability
---------------------------	----------------------------------------------

Product Compliance Disclaimer

This information is provided based on reasonable inquiry of our suppliers and represents our current actual knowledge based on the information they provided. This information is subject to change. The part numbers that TE has identified as EU RoHS compliant have a maximum concentration of 0.1% by weight in homogenous materials for lead, hexavalent chromium, mercury, PBB, PBDE, DBP, BBP, DEHP, DIBP, and 0.01% for cadmium, or qualify for an exemption to these limits as defined in the Annexes of Directive 2011/65/EU (RoHS2). Finished electrical and electronic equipment products will be CE marked as required by Directive 2011/65/EU. Components may not be CE marked. Additionally, the part numbers that TE has identified as EU ELV compliant have a maximum concentration of 0.1% by weight in homogenous materials for lead, hexavalent chromium, and mercury, and 0.01% for cadmium, or qualify for an exemption to these limits as defined in the Annexes of Directive 2000/53/EC (ELV). Regarding the REACH Regulation, the information TE provides on SVHC in articles for this part number is based on the latest European Chemicals Agency (ECHA) 'Guidance on requirements for substances in articles' posted at this URL: <https://echa.europa.eu/guidance-documents/guidance-on-reach>

Compatible Parts

 <p>TE Part # NB16192001 RW-175-1/16-0-STK</p>	 <p>TE Part # NB16204001 RW-175-1/16-X-SP</p>	 <p>TE Part # NB16212001 RW-175-1/16-X-STK</p>	 <p>TE Part # NB16262001 RW-175-1/2-0-STK</p>
 <p>TE Part # NB16274001 RW-175-1/2-X-SP</p>	 <p>TE Part # NB16324001 RW-175-1/4-0-SP</p>	 <p>TE Part # NB16332001 RW-175-1/4-0-STK</p>	 <p>TE Part # NB16352001 RW-175-1/4-X-STK</p>
 <p>TE Part # NB16392001 RW-175-1/8-0-STK</p>	 <p>TE Part # NB16412001 RW-175-1/8-X-STK</p>	 <p>TE Part # NB16474001 RW-175-3/16-0-SP</p>	 <p>TE Part # NB16482001 RW-175-3/16-0-STK</p>
 <p>TE Part # NB16544001 RW-175-3/32-0-SP</p>	 <p>TE Part # NB16552001 RW-175-3/32-0-STK</p>	 <p>TE Part # NB16564001 RW-175-3/32-X-SP</p>	 <p>TE Part # NB16622001 RW-175-3/64-X-STK</p>



Also in the Series | RAYCHEM RW-175

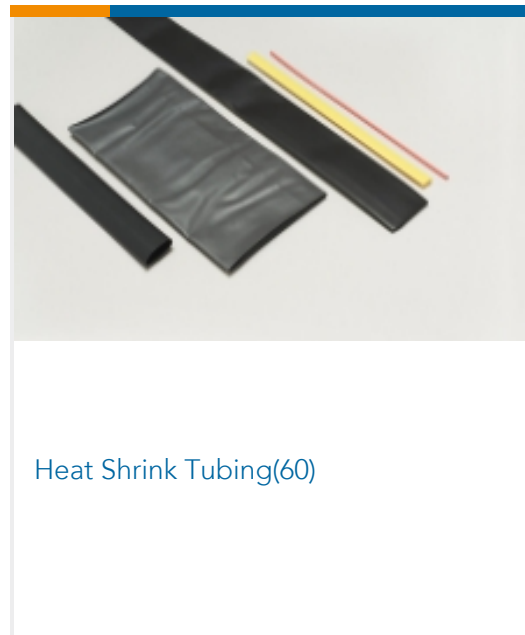

Customers Also Bought

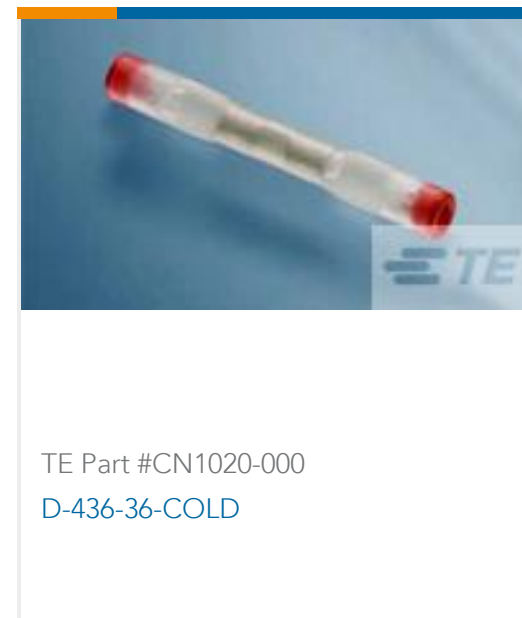
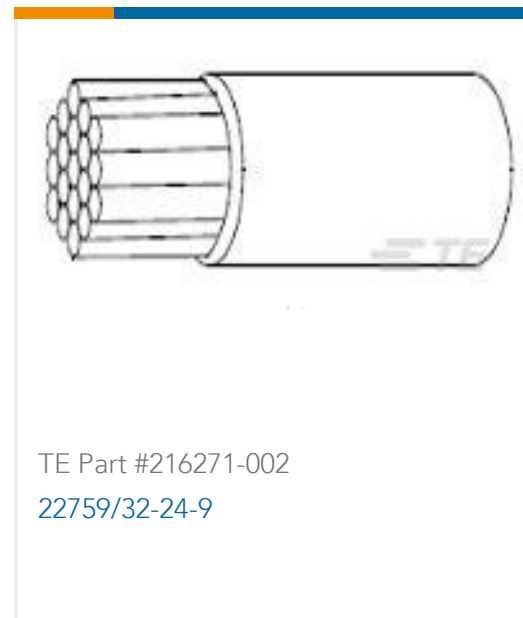

Documents

Product Drawings

RW-175-3/64-0-STK

English

Product Specifications

Product Specification

English