

# Converter - Brake - Inverter Module (CBI3) with Trench IGBT technology

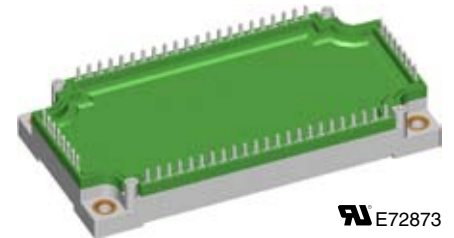
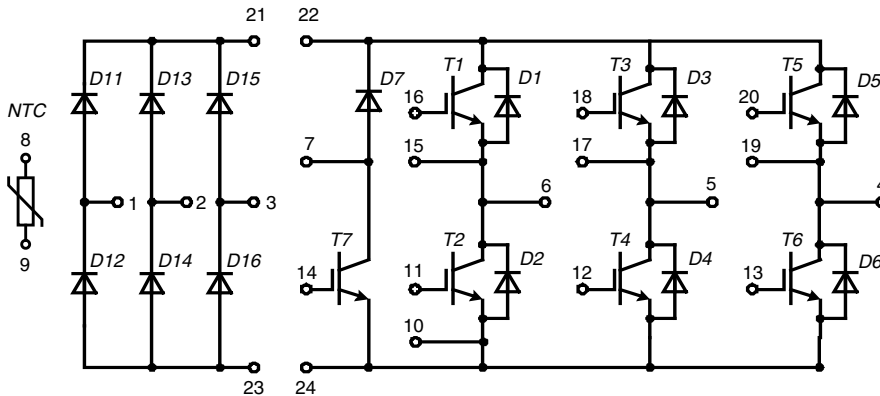

E72873

Three Phase Rectifier	Brake Chopper	Three Phase Inverter
$V_{RRM} = 2200 \text{ V}$	$V_{CES} = 1700 \text{ V}$	$V_{CES} = 1700 \text{ V}$
$I_{FAVM} = 70 \text{ A}$	$I_{C25} = 48 \text{ A}$	$I_{C25} = 113 \text{ A}$
$I_{FSM} = 700 \text{ A}$	$V_{CE(sat)} = 1.8 \text{ V}$	$V_{CE(sat)} = 2.0 \text{ V}$

Input Rectifier Bridge D11 - D16			
Symbol	Conditions	Maximum Ratings	
$V_{RRM}$		2200	V
$I_{FAV}$	$T_C = 80^\circ\text{C}$ ; sine $180^\circ$	50	A
$I_{DAVM}$	$T_C = 80^\circ\text{C}$ ; rectangular; $d = 1/3$ ; bridge	155	A
$I_{FSM}$	$T_C = 25^\circ\text{C}$ ; $t = 10 \text{ ms}$ ; sine 50 Hz	700	A
$P_{tot}$	$T_C = 25^\circ\text{C}$	130	W

Symbol	Conditions	Characteristic Values			
		(T <sub>VJ</sub> = 25°C, unless otherwise specified)			
		min.	typ.	max.	
$V_F$	$I_F = 75 \text{ A}$ ; $T_{VJ} = 25^\circ\text{C}$		1.4	1.5	V
		$T_{VJ} = 125^\circ\text{C}$		1.3	
$I_R$	$V_R = V_{RRM}$ ; $T_{VJ} = 25^\circ\text{C}$		1.5	0.05	mA
	$T_{VJ} = 125^\circ\text{C}$				mA
$R_{thJC}$	(per diode)			0.95	K/W

### Application: AC motor drives with

- Input from single or three phase grid
- Three phase synchronous or asynchronous motor
- Electric braking operation

### Features

- High level of integration - only one power semiconductor module required for the whole drive
- IGBT technology with low saturation voltage, low switching losses and tail current, high RBSOA and short circuit ruggedness
- Epitaxial free wheeling diodes with Hiperfast and soft reverse recovery
- Industry standard package with insulated copper base plate and soldering pins for PCB mounting
- Temperature sense included

Output Inverter T1 - T6			
Symbol	Conditions	Maximum Ratings	
$V_{CES}$	$T_{VJ} = 25^{\circ}\text{C}$ to $150^{\circ}\text{C}$	1700	V
$V_{GES}$	Continuous	$\pm 20$	V
$I_{C25}$	$T_C = 25^{\circ}\text{C}$	113	A
$I_{C80}$	$T_C = 80^{\circ}\text{C}$	80	A
$I_{CM}$	$T_C = 80^{\circ}\text{C}$ ; $t_p = 1$ ms	150	A
$P_{tot}$	$T_C = 25^{\circ}\text{C}$	450	W

Symbol	Conditions	Characteristic Values				
		(T <sub>VJ</sub> = 25°C, unless otherwise specified)				
		min.	typ.	max.		
$V_{CE(sat)}$	$I_C = 75$ A; $V_{GE} = 15$ V	$T_{VJ} = 25^{\circ}\text{C}$		2.0	2.4	V
		$T_{VJ} = 125^{\circ}\text{C}$		2.4		V
$V_{GE(th)}$	$I_C = 3$ mA; $V_{GE} = V_{CE}$	5		6.5	V	
$I_{CES}$	$V_{CE} = V_{CES}$ ; $V_{GE} = 0$ V		2.0	0.8	mA	
					mA	
$I_{GES}$	$V_{CE} = 0$ V; $V_{GE} = \pm 20$ V			400	nA	
$C_{iss}$	$V_{CE} = 25$ V; $V_{GE} = 0$ V; $f = 1$ MHz		6.6		nF	
$Q_{Gon}$	$V_{CE} = 900$ V; $V_{GE} = 15$ V; $I_C = 75$ A		850		nC	
$t_{d(on)}$ $t_r$ $t_{d(off)}$ $t_f$ $E_{on}$ $E_{off}$	Inductive load, $T_{VJ} = 125^{\circ}\text{C}$ $V_{CE} = 900$ V; $I_C = 75$ A $V_{GE} = \pm 15$ V; $R_G = 18$ $\Omega$		300		ns	
			60		ns	
			850		ns	
			500		ns	
			30		mJ	
			25		mJ	
<b>RBSOA</b>	$I_C = I_{CM}$ ; $V_{GE} = 15$ V $R_G = 18$ $\Omega$ ; $T_{VJ} = 125^{\circ}\text{C}$	$V_{CEK} \leq V_{CES} - L_S di/dt$			V	
<b>t<sub>SC</sub></b> <b>(SCSOA)</b>	$V_{CE} = 1000$ V; $V_{GE} = \pm 15$ V; $R_G = 18$ $\Omega$ $t_p \leq 10$ $\mu\text{s}$ ; non-repetitive; $T_{VJ} = 125^{\circ}\text{C}$		10		$\mu\text{s}$	
$R_{thJC}$				0.28	K/W	

Output Inverter D1 - D6						
Symbol	Conditions	Maximum Ratings				
$I_{F25}$	$T_C = 25^{\circ}\text{C}$	92	A			
$I_{F80}$	$T_C = 80^{\circ}\text{C}$	63	A			
Symbol	Conditions	Characteristic Values				
		min.	typ.	max.		
$V_F$	$I_F = 75$ A;	$T_{VJ} = 25^{\circ}\text{C}$		2.2	2.9	V
		$T_{VJ} = 125^{\circ}\text{C}$		2.3		V
$I_{RM}$	$I_F = 75$ A; $di_F/dt = -1400$ A/ $\mu\text{s}$ ; $T_{VJ} = 125^{\circ}\text{C}$ ; $V_R = 900$ V; $V_{GE} = 0$ V		95		A	
$Q_{rr}$			20		$\mu\text{C}$	
$t_{rr}$			800		ns	
$E_{rec}$			10		mJ	
$R_{thJC}$	(per diode)			0.4	K/W	

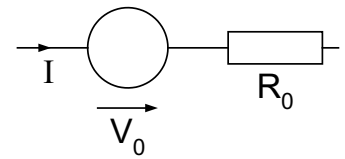
**Equivalent Circuits for Simulation**
**Conduction**

**IGBT** (typ. at  $V_{GE} = 15$  V;  $T_J = 125^{\circ}\text{C}$ )

*T1-T6*

$$V_0 = 1.0 \text{ V}; R_0 = 17 \text{ m}\Omega$$

*T7*

$$V_0 = 1.0 \text{ V}; R_0 = 28 \text{ m}\Omega$$

**Diode** (typ. at  $T_J = 125^{\circ}\text{C}$ )

*D1-D6*

$$V_0 = 1.4 \text{ V}; R_0 = 11 \text{ m}\Omega$$

*D7*

$$V_0 = 1.65 \text{ V}; R_0 = 37 \text{ m}\Omega$$

*D11-D16*

$$V_0 = 0.85 \text{ V}; R_0 = 2.8 \text{ m}\Omega$$

<b>Brake Chopper T7</b>			
<b>Symbol</b>	<b>Conditions</b>	<b>Maximum Ratings</b>	
$V_{CES}$	$T_{VJ} = 25^{\circ}\text{C}$ to $150^{\circ}\text{C}$	1700	V
$V_{GES}$	Continuous	$\pm 20$	V
$I_{C25}$	$T_C = 25^{\circ}\text{C}$	48	A
$I_{C80}$	$T_C = 80^{\circ}\text{C}$	34	A
$I_{CM}$	$T_C = 80^{\circ}\text{C}$ ; $t_p = 1$ ms	60	A
$P_{tot}$	$T_C = 25^{\circ}\text{C}$	200	W

<b>Symbol</b>	<b>Conditions</b>	<b>Characteristic Values</b>			
( $T_{VJ} = 25^{\circ}\text{C}$ , unless otherwise specified)					
		<b>min.</b>	<b>typ.</b>	<b>max.</b>	
$V_{CE(sat)}$	$I_C = 30$ A; $V_{GE} = 15$ V				$T_{VJ} = 25^{\circ}\text{C}$
					$T_{VJ} = 125^{\circ}\text{C}$
$V_{GE(th)}$	$I_C = 2$ mA; $V_{GE} = V_{CE}$	5		6.5	V
$I_{CES}$	$V_{CE} = V_{CES}$ ; $V_{GE} = 0$ V				$T_{VJ} = 25^{\circ}\text{C}$
					$T_{VJ} = 125^{\circ}\text{C}$
$I_{GES}$	$V_{CE} = 0$ V; $V_{GE} = \pm 20$ V			400	nA
$C_{ies}$	$V_{CE} = 25$ V; $V_{GE} = 0$ V; $f = 1$ MHz		4.4		nF
$Q_{Gon}$	$V_{CE} = 900$ V; $V_{GE} = 15$ V; $I_C = 30$ A		600		nC
$t_{d(on)}$ $t_r$ $t_{d(off)}$ $t_f$ $E_{off}$ $E_{on}$	Inductive load, $T_{VJ} = 125^{\circ}\text{C}$ $V_{CE} = 900$ V; $I_C = 30$ A $V_{GE} = \pm 15$ V; $R_G = 45$ $\Omega$				190
					45
					970
					340
					7.5
8.5					
<b>RBSOA</b>	$I_C = I_{CM}$ ; $V_{GE} = 15$ V $R_G = 27$ $\Omega$ ; $T_{VJ} = 125^{\circ}\text{C}$				$V_{CEK} \leq V_{CES} - L_S di/dt$
<b><math>t_{SC}</math> (SCSOA)</b>	$V_{CE} = 900$ V; $V_{GE} = \pm 15$ V; $R_G = 45$ $\Omega$ $t_p \leq 10$ $\mu\text{s}$ ; non-repetitive; $T_{VJ} = 125^{\circ}\text{C}$		10		$\mu\text{s}$
$R_{thJC}$				0.62	K/W

<b>Brake Chopper D7</b>			
<b>Symbol</b>	<b>Conditions</b>	<b>Maximum Ratings</b>	
$V_{RRM}$	$T_{VJ} = 25^{\circ}\text{C}$ to $150^{\circ}\text{C}$	1700	V
$I_{F25}$	$T_C = 25^{\circ}\text{C}$	30	A
$I_{F80}$	$T_C = 80^{\circ}\text{C}$	21	A

<b>Symbol</b>	<b>Conditions</b>	<b>Characteristic Values</b>			
		<b>min.</b>	<b>typ.</b>	<b>max.</b>	
$V_F$	$I_F = 30$ A;				$T_{VJ} = 25^{\circ}\text{C}$
					$T_{VJ} = 125^{\circ}\text{C}$
$I_R$	$V_R = V_{RRM}$ ;				$T_{VJ} = 25^{\circ}\text{C}$
					$T_{VJ} = 125^{\circ}\text{C}$
$I_{RM}$ $t_{rr}$	$I_F = 30$ A; $di_F/dt = -700$ A/ $\mu\text{s}$ ; $T_{VJ} = 125^{\circ}\text{C}$ $V_R = 900$ V				38
					670
$R_{thJC}$	(per diode)			0.9	K/W

Temperature Sensor NTC					
Symbol	Conditions	Characteristic Values			
		min.	typ.	max.	
$R_{25}$	$T = 25^{\circ}\text{C}$	4.75	5.0	5.25	k $\Omega$
$B_{25/50}$			3375		K

Module			
Symbol	Conditions	Maximum Ratings	
$T_{VJ}$	operating	-40...+125	$^{\circ}\text{C}$
$T_{JM}$		+150	$^{\circ}\text{C}$
$T_{stg}$		-40...+125	$^{\circ}\text{C}$
$V_{ISO}$	$I_{ISOL} \leq 1 \text{ mA}; 50/60 \text{ Hz}; 1 \text{ min.}$	3400	V~
$M_d$	Mounting torque (M5)	3 - 6	Nm

Symbol	Conditions	Characteristic Values		
		min.	typ.	max.
$R_{\text{therm-chip}}$	Resistance terminal to chip		7	m $\Omega$
$d_s$	Creepage distance on surface	12.7		mm
$d_A$	Strike distance in air	9.6		mm
$R_{thCH}$	with heatsink compound		0.01	K/W
<b>Weight</b>			300	g

Dimensions in mm (1 mm = 0.0394")

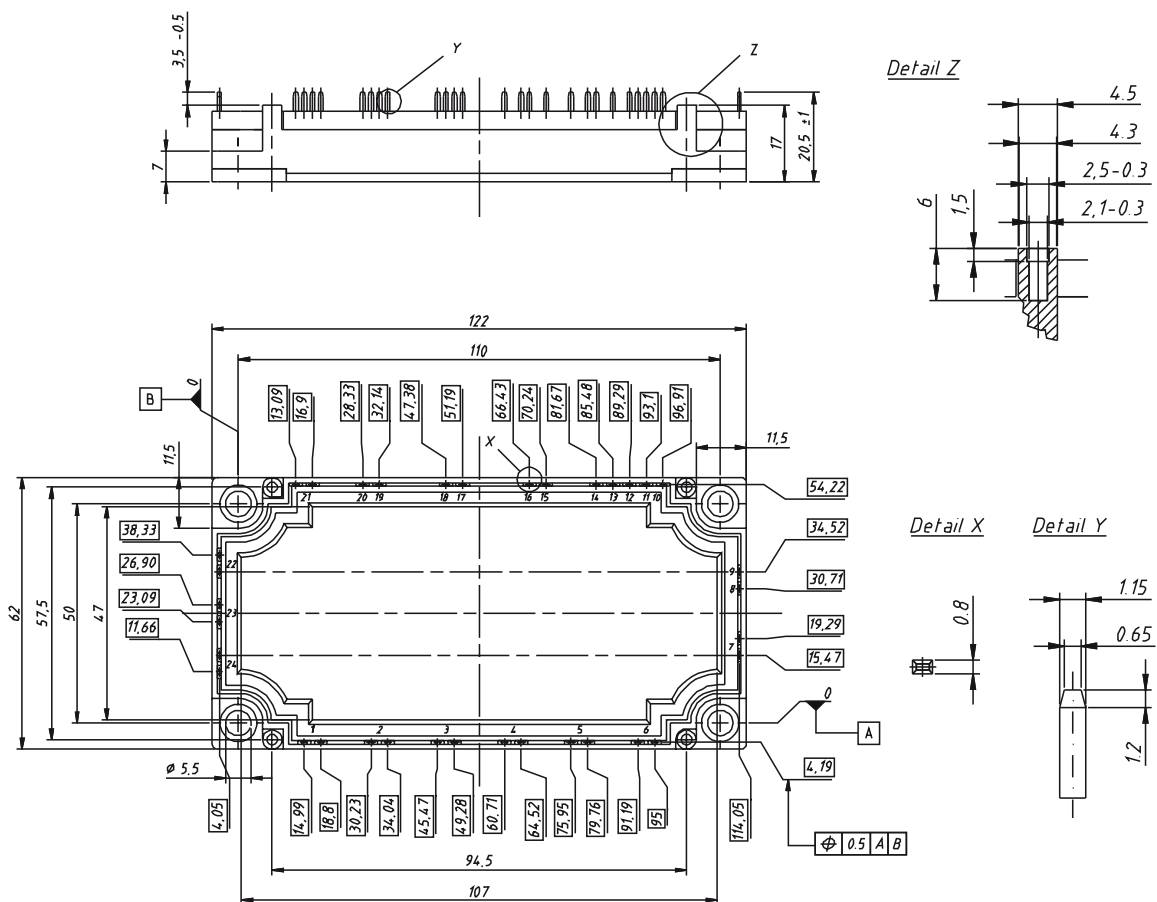

IXYS reserves the right to change limits, test conditions and dimensions.

20090826a

© 2009 IXYS All rights reserved

4 - 8

## Input Rectifier Bridge D11 - D16

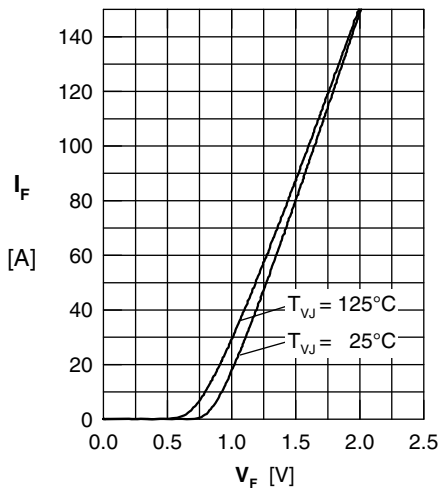

Fig. 1 Typ. forward current vs. voltage drop per diode

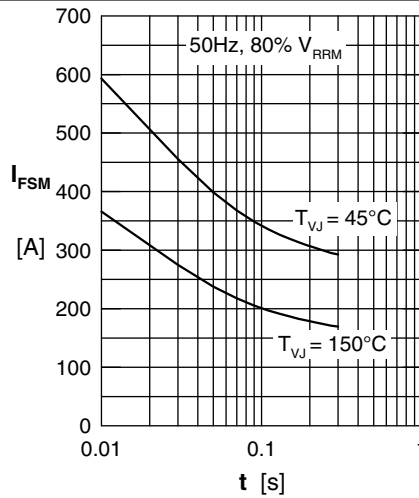

Fig. 2 Surge overload current

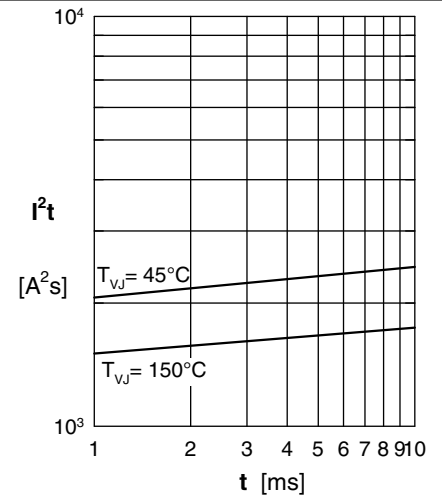

Fig. 3  $I^2t$  versus time per diode

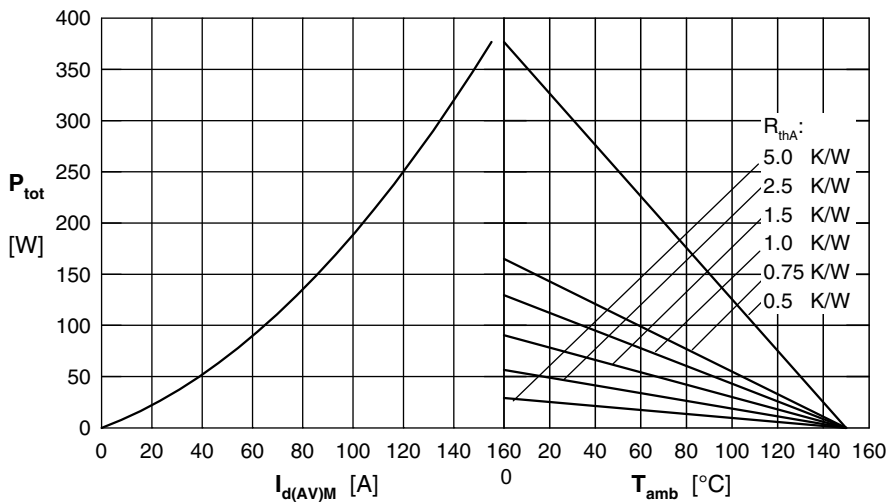

Fig. 4 Power dissipation vs. direct output current & amb. temperature, sin 180°

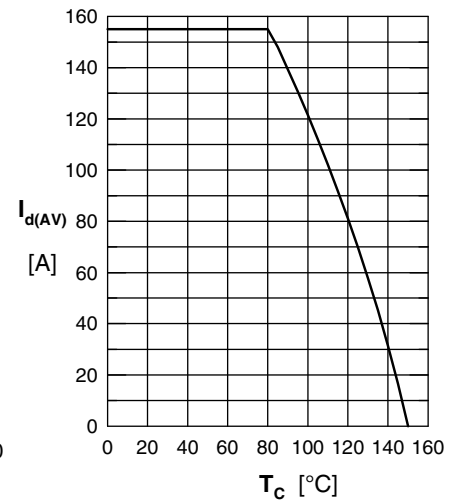

Fig. 5 Max. forward current vs. case temperature

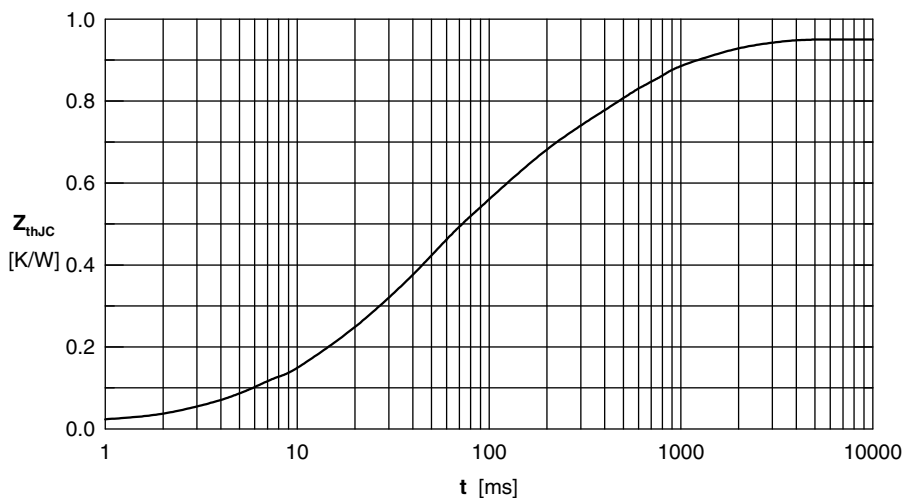
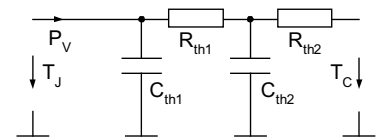

Fig. 6 Transient thermal impedance junction to case



	$R_i$	$\tau_i$
1	0.049	0.0085
2	0.012	0.0017
3	0.465	0.045
4	0.105	0.85
5	0.32	0.33

**Output Inverter T1 - T6 / D1 - D6**

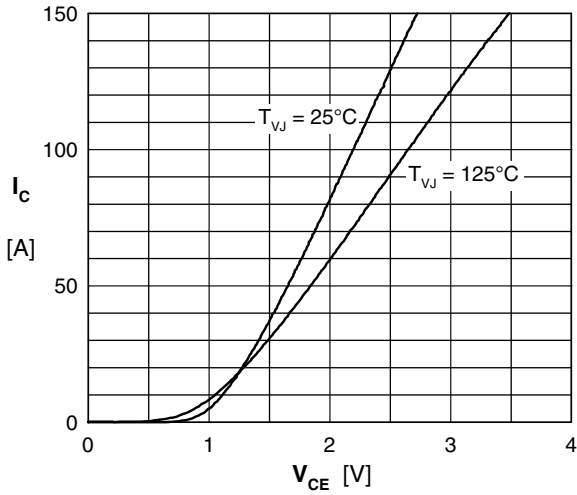

Fig. 7 Typical output characteristic

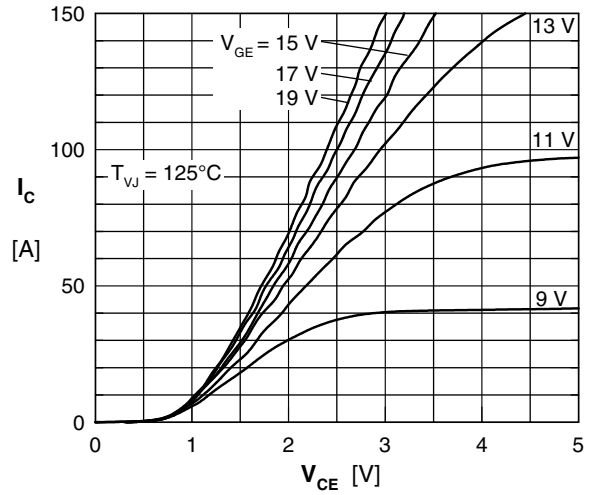

Fig. 8 Typical output characteristic

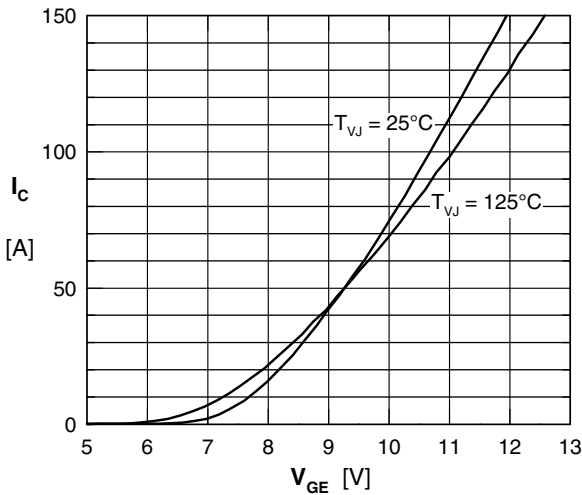

Fig. 9 Typical transfer characteristic

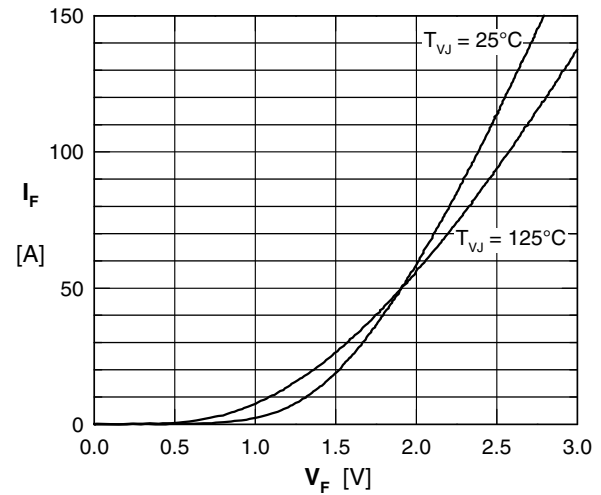

Fig. 10 Typical forward characteristic of free wheeling diode

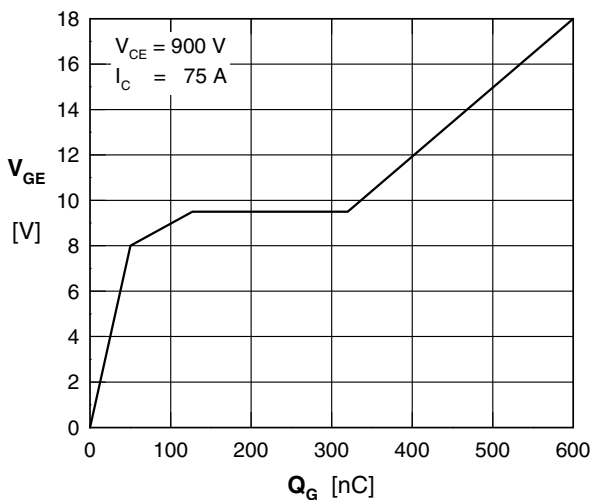

Fig. 11 Typical turn on gate charge

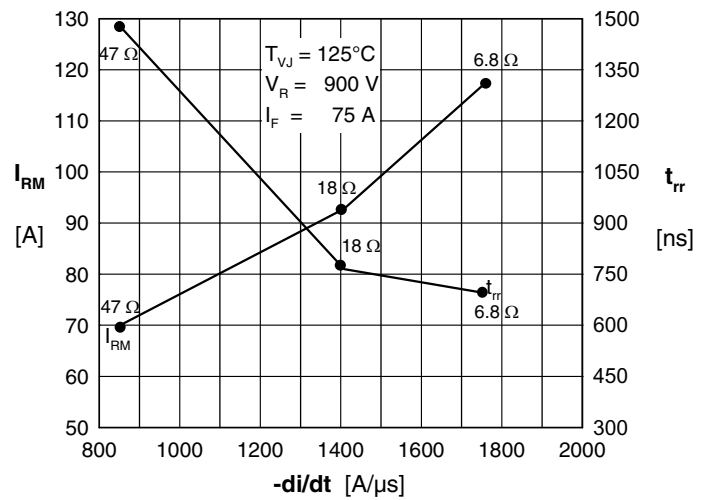

Fig. 12 Typ. turn-off characteristics of free wheeling diode

## Output Inverter T1 - T6 / D1 - D6

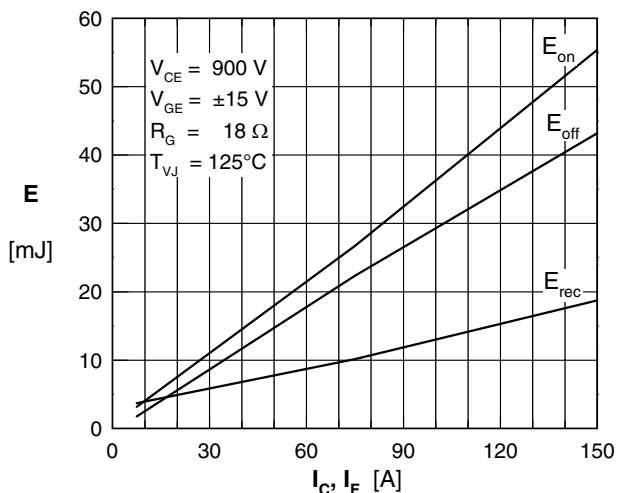

Fig. 13 Typ. turn on energy & switching times versus collector current

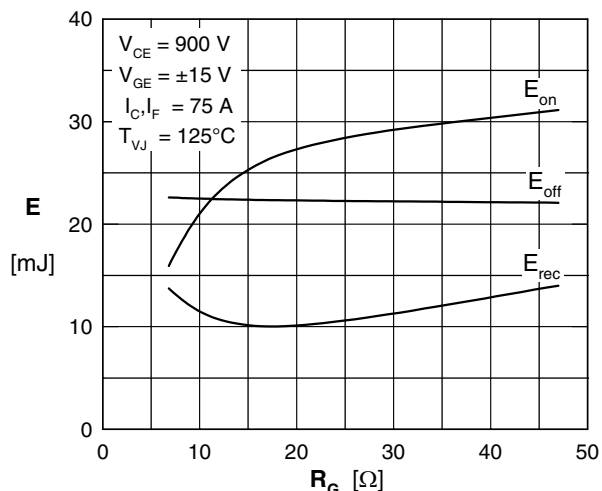

Fig. 14 Typ. turn off energy and switching times versus collector current

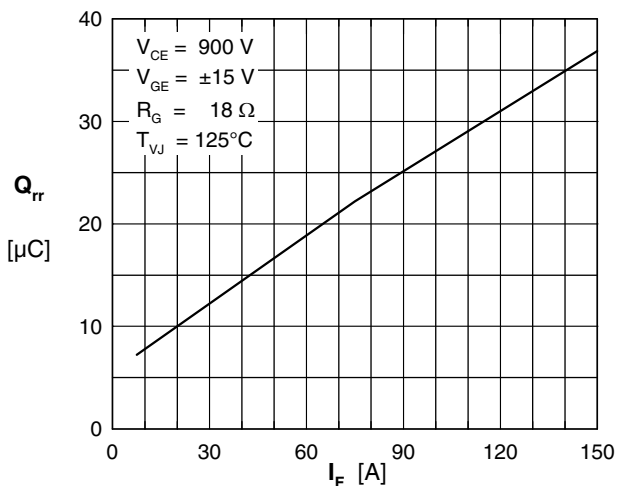

Fig. 15 Typical turn-off characteristics of free wheeling diode

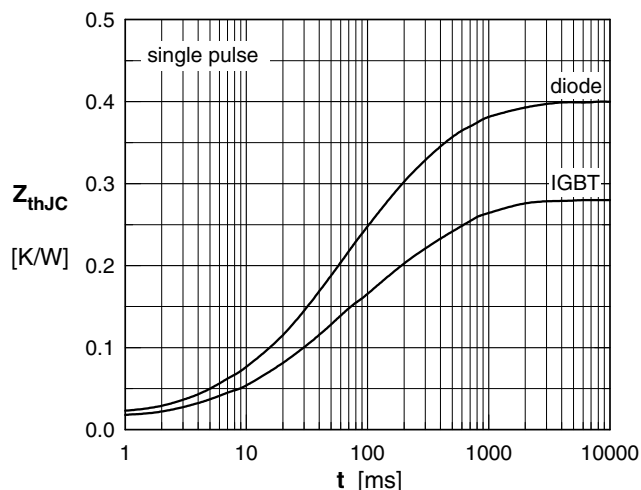

Fig. 16 Transient thermal impedance junction to case

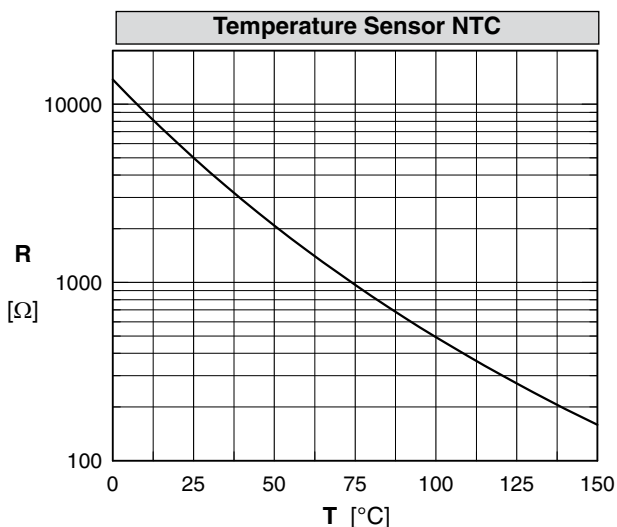
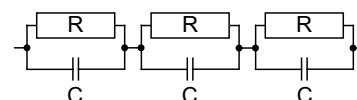

Fig. 17 Typ. transient thermal impedance

	IGBT		Diode	
	R <sub>i</sub>	τ <sub>i</sub>	R <sub>i</sub>	τ <sub>i</sub>
1	0.0175	0.0015	0.0265	0.0020
2	0.0860	0.0276	0.1443	0.0318
3	0.0920	0.1311	0.1655	0.1618
4	0.0832	0.6329	0.0636	0.8218



**Brake Chopper T7 / D7**

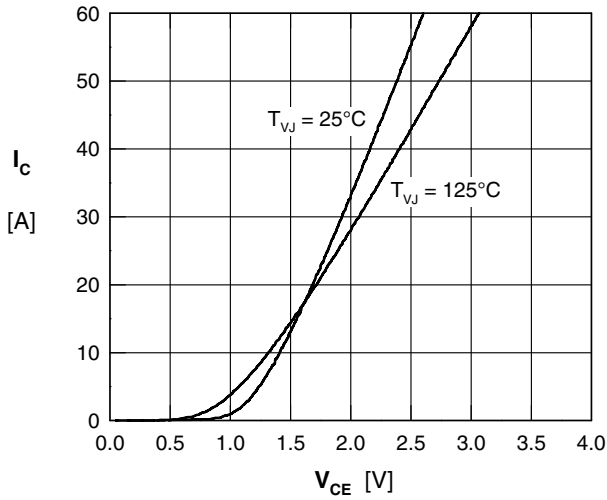

Fig. 18 Typical output characteristic

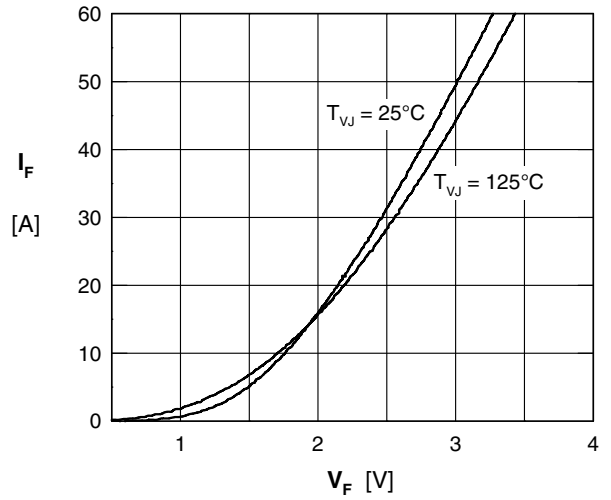

Fig. 19 Typ. forward characteristics of brake diode

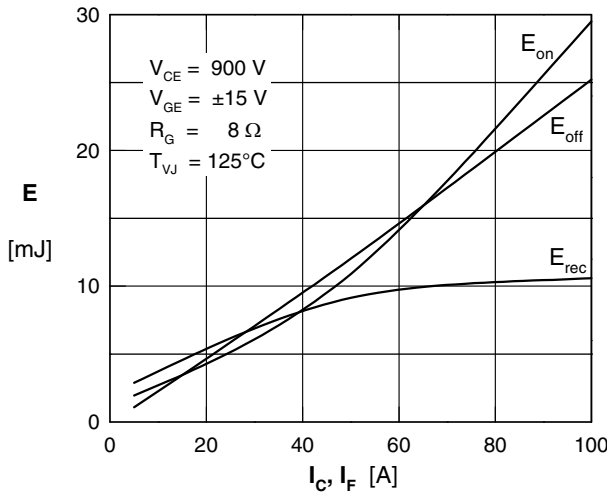

Fig. 20 Typ. turn on energy & switching times versus collector current

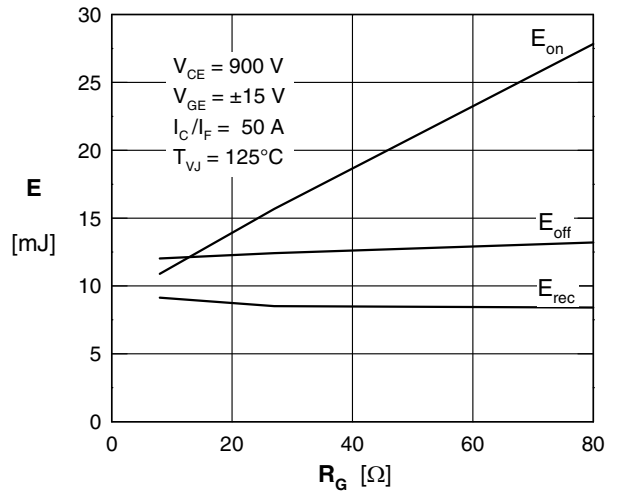

Fig. 21 Typ. turn off energy and switching times versus collector current

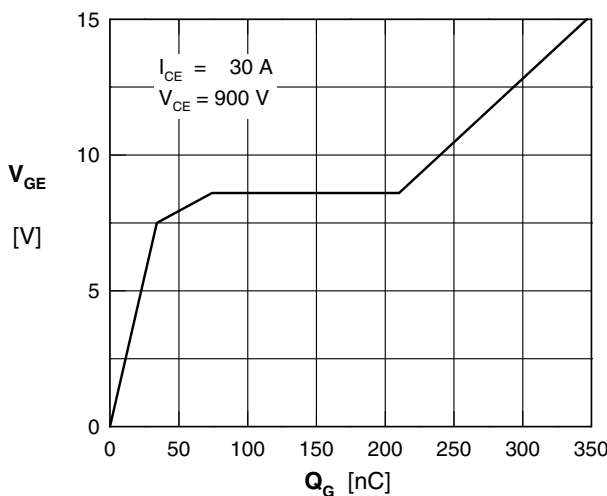

Fig. 22 Typ. turn on gate charge

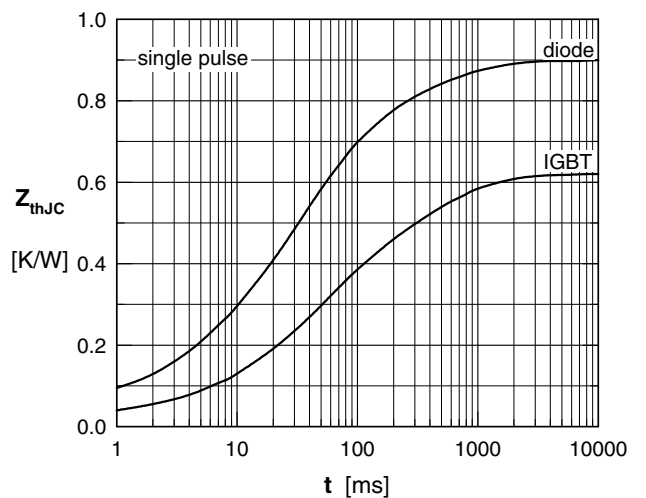

Fig. 23 Typ. NTC resistance versus temperature