

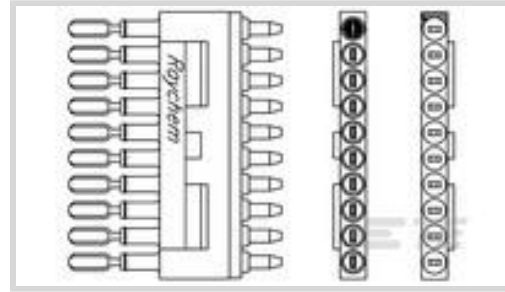

Connectors > Rectangular Connectors > Rectangular Contact Inserts



Rectangular Connector Insert Type: **Contact Insert**

Contact Type: **Socket**

Connector System: **Wire-to-Wire**

Number of Positions: **20**

Sealable: **Yes**

Features

Product Type Features

Connector & Contact Terminates To	Wire & Cable
Rectangular Connector Insert Type	Contact Insert
Connector System	Wire-to-Wire
Sealable	Yes

Configuration Features

Number of Positions	20
---------------------	----

Body Features

Seal Type	Interfacial Seal
Primary Product Material	High Grade Polyarylene Thermoplastic
Primary Product Color	Black

Contact Features

Contact Type	Socket
Contact Current Rating (Max)	1.5 A

Mechanical Attachment

Polarization Code	B
Connector Mounting Type	Panel Mount

Housing Features

Centerline (Pitch)	1.27 mm[.05 in]
--------------------	-----------------



Usage Conditions

Operating Temperature Range	-65 – 125 °C[-85 – 257 °F]
-----------------------------	----------------------------

Operation/Application

Compatible With Connector Shell Size	50.8 [2.0]
--------------------------------------	------------

Product Compliance

[For compliance documentation, visit the product page on TE.com>](#)

EU RoHS Directive 2011/65/EU	Compliant
EU ELV Directive 2000/53/EC	Compliant
China RoHS 2 Directive MIIT Order No 32, 2016	No Restricted Materials Above Threshold
EU REACH Regulation (EC) No. 1907/2006	Current ECHA Candidate List: JUNE 2024 (241) Candidate List Declared Against: JAN 2024 (240) Does not contain REACH SVHC
Halogen Content	Not Yet Reviewed for halogen content
Solder Process Capability	Not applicable for solder process capability

Product Compliance Disclaimer

This information is provided based on reasonable inquiry of our suppliers and represents our current actual knowledge based on the information they provided. This information is subject to change. The part numbers that TE has identified as EU RoHS compliant have a maximum concentration of 0.1% by weight in homogenous materials for lead, hexavalent chromium, mercury, PBB, PBDE, DBP, BBP, DEHP, DIBP, and 0.01% for cadmium, or qualify for an exemption to these limits as defined in the Annexes of Directive 2011/65/EU (RoHS2). Finished electrical and electronic equipment products will be CE marked as required by Directive 2011/65/EU. Components may not be CE marked. Additionally, the part numbers that TE has identified as EU ELV compliant have a maximum concentration of 0.1% by weight in homogenous materials for lead, hexavalent chromium, and mercury, and 0.01% for cadmium, or qualify for an exemption to these limits as defined in the Annexes of Directive 2000/53/EC (ELV). Regarding the REACH Regulation, the information TE provides on SVHC in articles for this part number is based on the latest European Chemicals Agency (ECHA) 'Guidance on requirements for substances in articles' posted at this URL: <https://echa.europa.eu/guidance-documents/guidance-on-reach>

Customers Also Bought

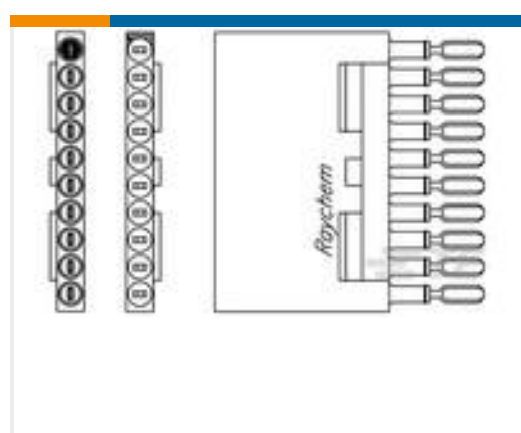

TE Part #699232-000
MTCB1X-XXX-106

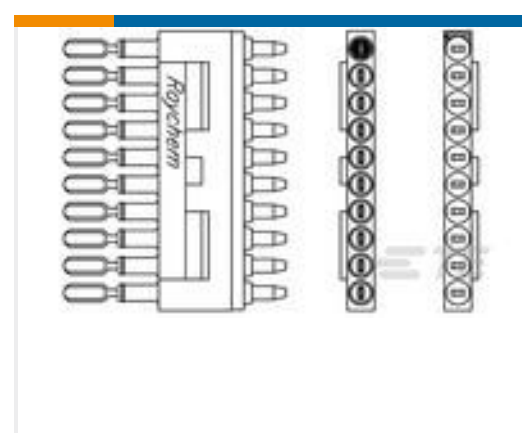

TE Part #699226-000
MTCB1X-106-XXX

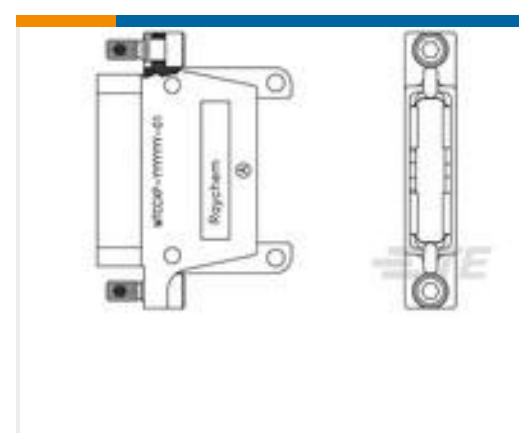

TE Part #364283-000
MTCC1P-010-010-01



TE Part #981759-000
MTCC1P-COAX-01P-01

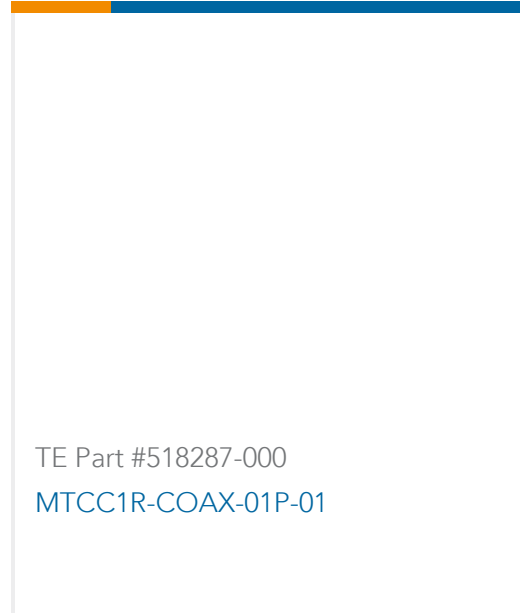
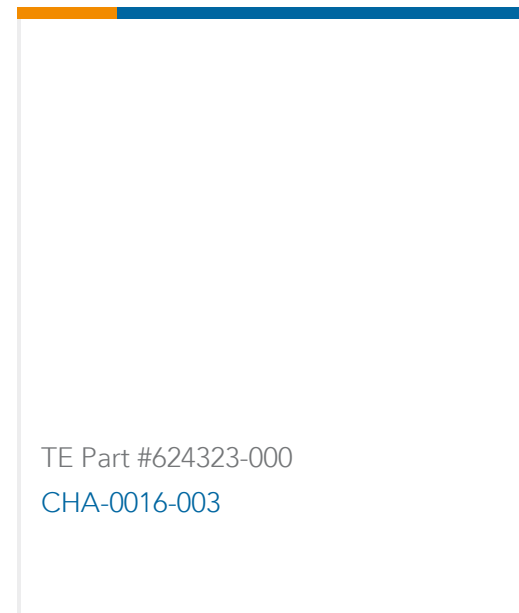
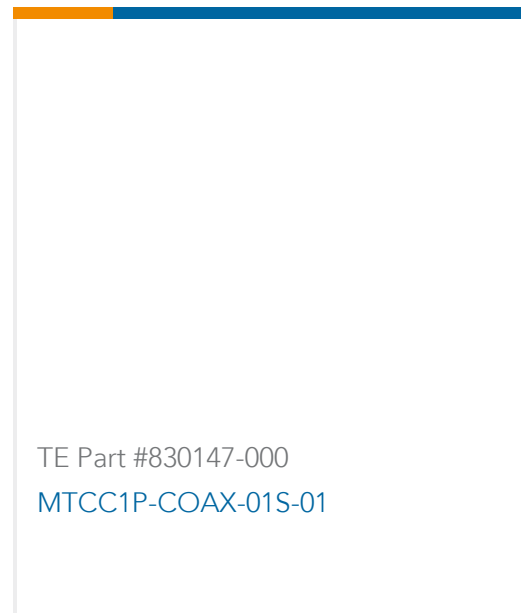
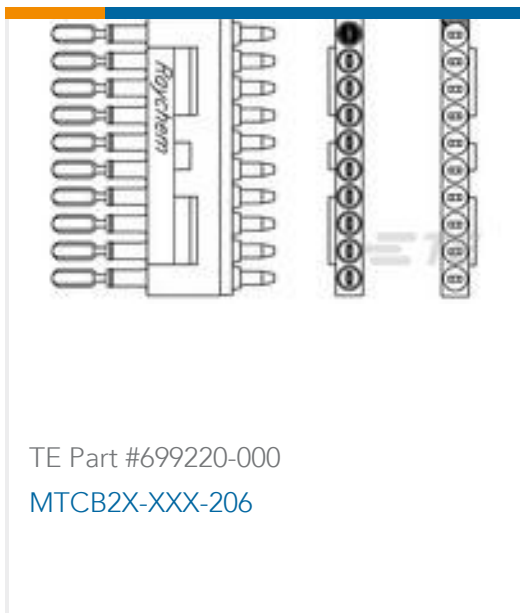

Documents

Product Drawings

[MTCB2X-206-XXX](#)

English

CAD Files

[3D PDF](#)

3D

Customer View Model

[ENG_CVM_CVM_699214-000_B.2d_dxf.zip](#)

English

Customer View Model

[ENG_CVM_CVM_699214-000_B.3d_igs.zip](#)

English

Customer View Model

[ENG_CVM_CVM_699214-000_B.3d_stp.zip](#)

English

By downloading the CAD file I accept and agree to the [Terms and Conditions](#) of use.

Product Specifications

[MTC Connectors with Fixed Contacts](#)

English