

PIN Diode Shunt Switch Element

Rev. V2

Features

- Supports up to 20 W Power when Cold Switched
- Low Insertion Loss: 0.25 dB to 2.7 GHz
- High Isolation: 31 dB to 2.7 GHz
- RoHS* Compliant

Description

A broadband, high linearity, medium power shunt switch element in a 1.9 x 1.1 mm DFN package.

This device is designed for WiMax, Wibro, WLAN, TD-SCDMA and other wireless infrastructure applications. It is also suited for 0.1 ~ 6 GHz applications with up to 20 watts of power.

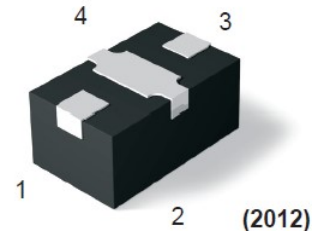

Pin Out / Schematic

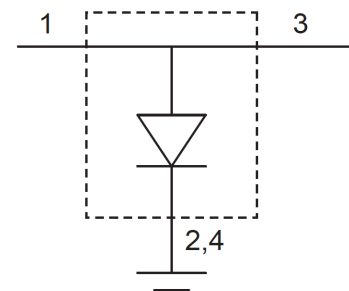

Ordering Information

Part Number	Package
MSWSH-020-30	500 piece reel

Electrical Specifications: $T_A = +25^\circ\text{C}$

Parameter	Test Conditions	Units	Min.	Typ.	Max.
Breakdown Voltage (V_B)	$I_R = 10 \mu\text{A}$	V	100	—	—
Junction Capacitance (C_J)	$V_R = 10 \text{ V}$, 1 MHz	pF	—	0.13	—
Series Resistance (R_S)	$I_F = 50 \text{ mA}$, 500 MHz	Ω	—	0.6	0.9
I-Region (W)	I-Layer	μm	—	15	—
Insertion Loss (I_L)	$V_R = 10 \text{ V}$, 2.3 - 2.7 GHz $V_R = 10 \text{ V}$, 6.0 GHz	dB	—	0.25 0.35	0.35 0.45
Isolation (I_{SO})	$I_F = 50 \text{ mA}$, 2.3 - 2.7 GHz $I_F = 50 \text{ mA}$, 6.0 GHz	dB	26 25	31 27	—
Input Return Loss (R_L)	$V_R = 10 \text{ V}$, 2.3 - 2.7 GHz $V_R = 10 \text{ V}$, 6.0 GHz	dB	15 10	19 14	—
Minority Carrier Lifetime (T_L)	$I_F = 10 \text{ mA}$, $I_R = 10 \text{ mA}$, @ 50%	ns	—	600	—

* Restrictions on Hazardous Substances, compliant to current RoHS EU directive.

Absolute Maximum Ratings

Parameter	Absolute Maximum
Breakdown Voltage	100 V
Forward Current	100 mA
Thermal Resistance	30°C/W
Junction Temperature	+175°C
Storage Temperature	-65°C to +150°C
Assembly Temperature	+260°C Per JEDEC STD-J-20C

Typical Performance Curves

Insertion Loss

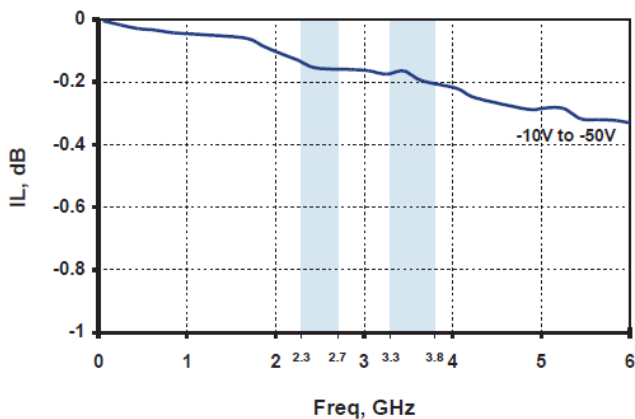

Input Return Loss

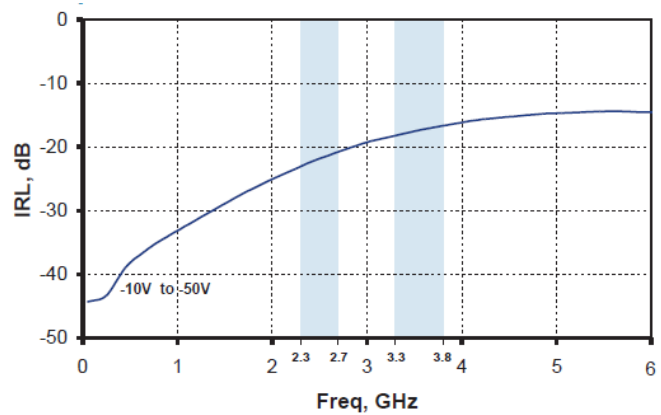

Isolation

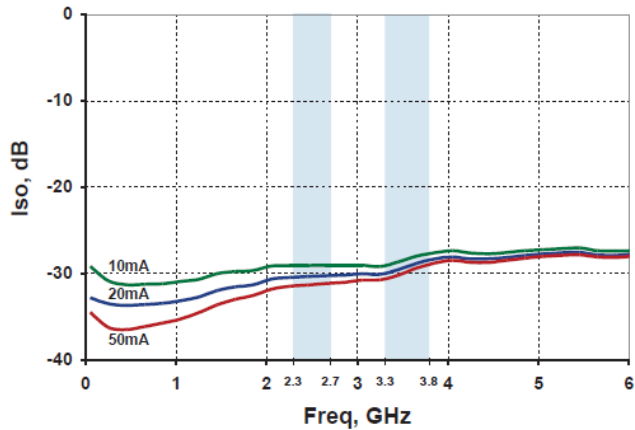

Series Resistance vs. Current, 500 MHz

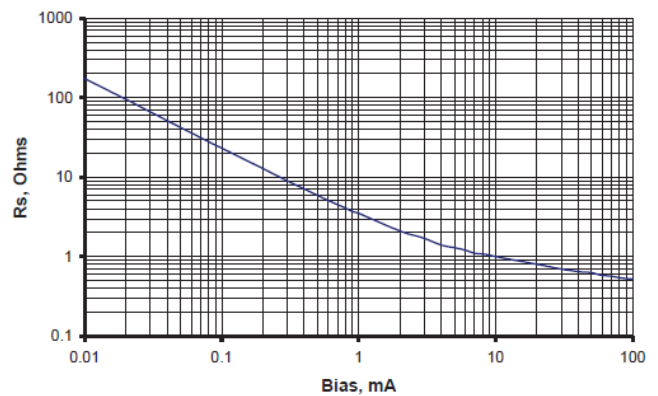

PIN Diode Shunt Switch Element

Rev. V2

Bias Schematic (0.1 - 6 GHz)

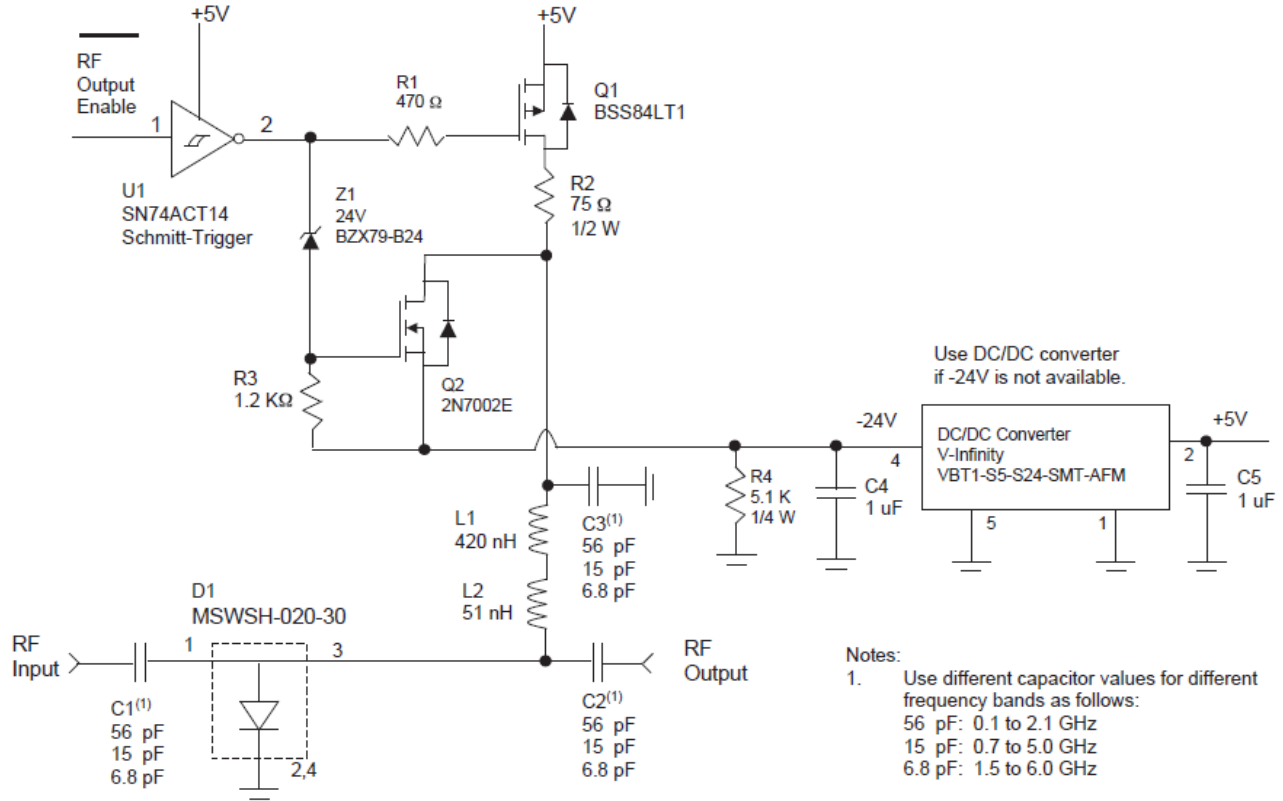

Parts List

Component	Description	Manufacture	Manufacture Part #
R1	470 Ω, 1/10 W, 0603 chip resistor	KOA Speer	RK73B1JTDD471J
R2	75 Ω, 1/2 W, 1210 chip resistor	KOA Speer	RK73B2ETTD750J
R3	1.2 KΩ, 1/10 W, 0603 chip resistor	KOA Speer	RK73B1JTDD122J
R4	5.1 KΩ, 1/4 W, 1206 chip resistor	KOA Speer	RK73B2BTDD512J
C1,C2,C3 ¹	56 pF, 250 VDC Capacitor, 0603 pkg	ATC	ATC600S560JT250XT
C1,C2,C3 ¹	15 pF, 250 VDC Capacitor, 0603 pkg	ATC	ATC600S150JT250XT
C1,C2,C3 ¹	6.8 pF, 250 VDC Capacitor, 0603 pkg	ATC	ATC600S6R8JT250XT
C4,C5	1 μF, 50 WVDC Capacitor, 1206 pkg	ATC	ATC1206Z5U105MT2AT
L1	420 nH, 340 mA, 700 MHz SRF Inductor	Coilcraft	0402AF-421XJLW
L2	51 nH, 330 mA, 2.3 GHz SRF, Inductor	Coilcraft	0402HP-51NXJLW
Q1	50 V, 130 mA, P-Channel MOSFET	ON SEMI	BSS84LT1
Q2	60 V, 310 mA, N-Channel MOSFET	ON SEMI	2N7002E
U1	Hex Schmitt-Trigger TTL Inverter	Texas Instruments	SN74ACT14
Z1	24 V, 2%, 500 mW Zener Diode	Philips	BZX79-B24
DC1	1 W, 5 V to 24 V DC/DC Converter	V-Infinity	VBT1-S5-S24-SMT-AFM

- Use different capacitor values for different frequency bands as follows:
 56 pF: 0.1 to 2.1 GHz
 15 pF: 0.7 to 5.0 GHz
 6.8 pF: 1.5 to 6.0 GHz

PIN Diode Shunt Switch Element

Rev. V2

Printed Circuit Board Layout

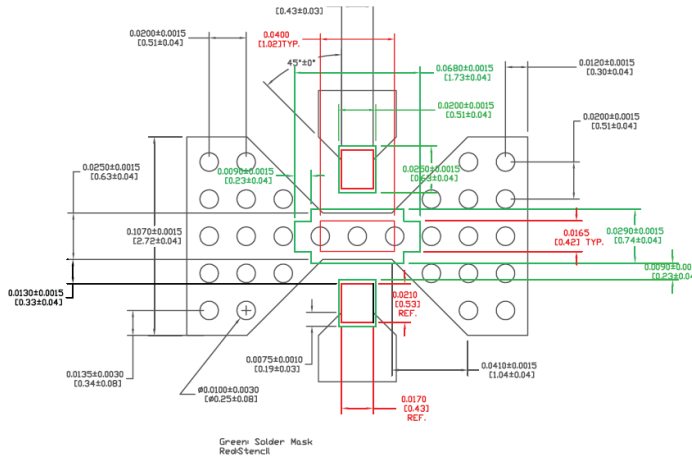

NOTE: If possible, use copper filled vias underneath pin 2 and 4 for better thermals; otherwise, use vias that are plated through, filled and plated over.

Solder mask should provide a 60 um clearance between copper pad and soldermask. Rounded pkg pads should have matching rounded solder mask openings.

Use circles or squares for the thermal land stencil such that only get 50% to 80% solder paste coverage.

Outline (2012)

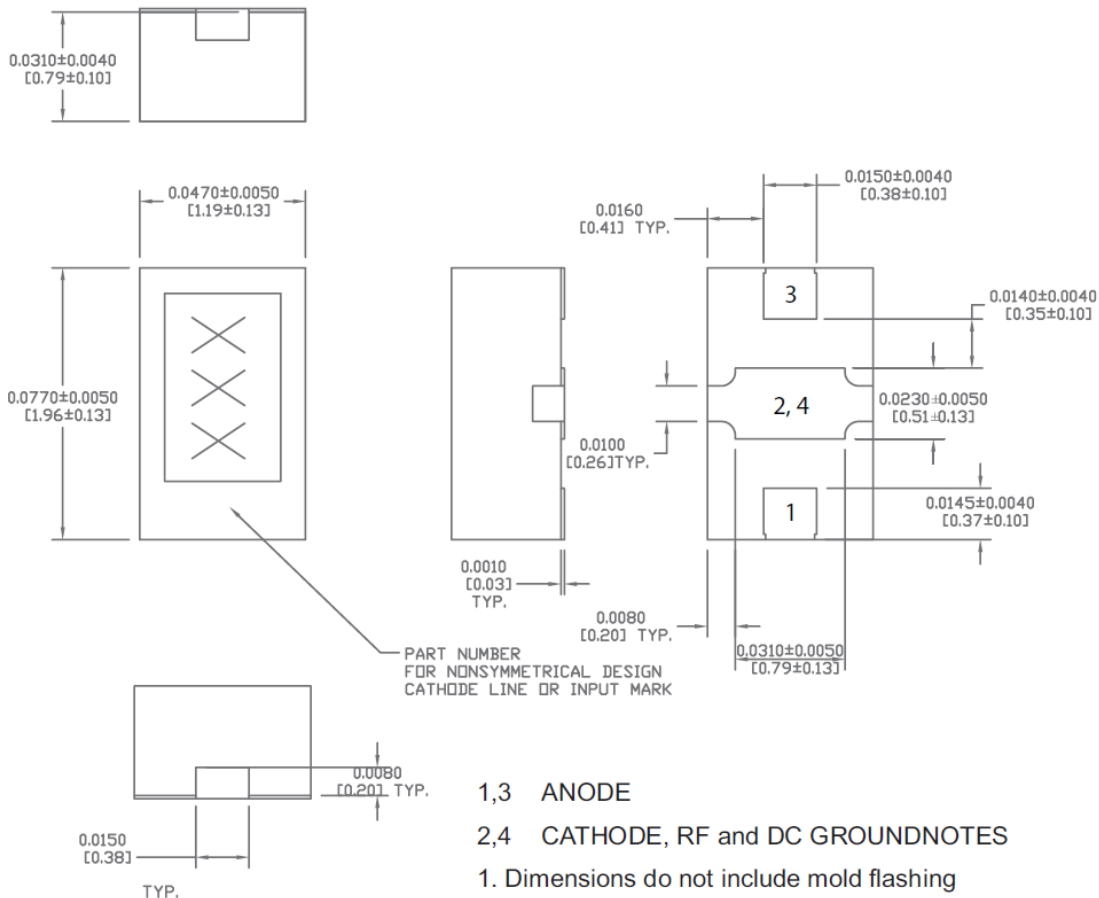

- 1,3 ANODE
- 2,4 CATHODE, RF and DC GROUNDNOTES
- 1. Dimensions do not include mold flashing
- 2. Burrs and dumber shall not exceed 0.002" per surface.
- 3. Lead co-planarity is 0.003" max

4 Dimensions: inches [mm]

MACOM Technology Solutions Inc. (MACOM) and its affiliates reserve the right to make changes to the product(s) or information contained herein without notice. Visit www.macom.com for additional data sheets and product information.

MACOM Technology Solutions Inc. All rights reserved.

Information in this document is provided in connection with MACOM Technology Solutions Inc ("MACOM") products. These materials are provided by MACOM as a service to its customers and may be used for informational purposes only. Except as provided in MACOM's Terms and Conditions of Sale for such products or in any separate agreement related to this document, MACOM assumes no liability whatsoever. MACOM assumes no responsibility for errors or omissions in these materials. MACOM may make changes to specifications and product descriptions at any time, without notice. MACOM makes no commitment to update the information and shall have no responsibility whatsoever for conflicts or incompatibilities arising from future changes to its specifications and product descriptions. No license, express or implied, by estoppel or otherwise, to any intellectual property rights is granted by this document.

THESE MATERIALS ARE PROVIDED "AS IS" WITHOUT WARRANTY OF ANY KIND, EITHER EXPRESS OR IMPLIED, RELATING TO SALE AND/OR USE OF MACOM PRODUCTS INCLUDING LIABILITY OR WARRANTIES RELATING TO FITNESS FOR A PARTICULAR PURPOSE, CONSEQUENTIAL OR INCIDENTAL DAMAGES, MERCHANTABILITY, OR INFRINGEMENT OF ANY PATENT, COPYRIGHT OR OTHER INTELLECTUAL PROPERTY RIGHT. MACOM FURTHER DOES NOT WARRANT THE ACCURACY OR COMPLETENESS OF THE INFORMATION, TEXT, GRAPHICS OR OTHER ITEMS CONTAINED WITHIN THESE MATERIALS. MACOM SHALL NOT BE LIABLE FOR ANY SPECIAL, INDIRECT, INCIDENTAL, OR CONSEQUENTIAL DAMAGES, INCLUDING WITHOUT LIMITATION, LOST REVENUES OR LOST PROFITS, WHICH MAY RESULT FROM THE USE OF THESE MATERIALS.

MACOM products are not intended for use in medical, lifesaving or life sustaining applications. MACOM customers using or selling MACOM products for use in such applications do so at their own risk and agree to fully indemnify MACOM for any damages resulting from such improper use or sale.