



Alcoswitch | Alcoswitch MSS

TE Internal #: 1825266-1

Slide Switches, Four Pole - Double Throw Configuration (Pole-Throw), Vertical, Copper Alloy, Single Actuator, 2 Position, On On, Alcoswitch MSS

[View on TE.com >](#)

Switches > Slide Switches

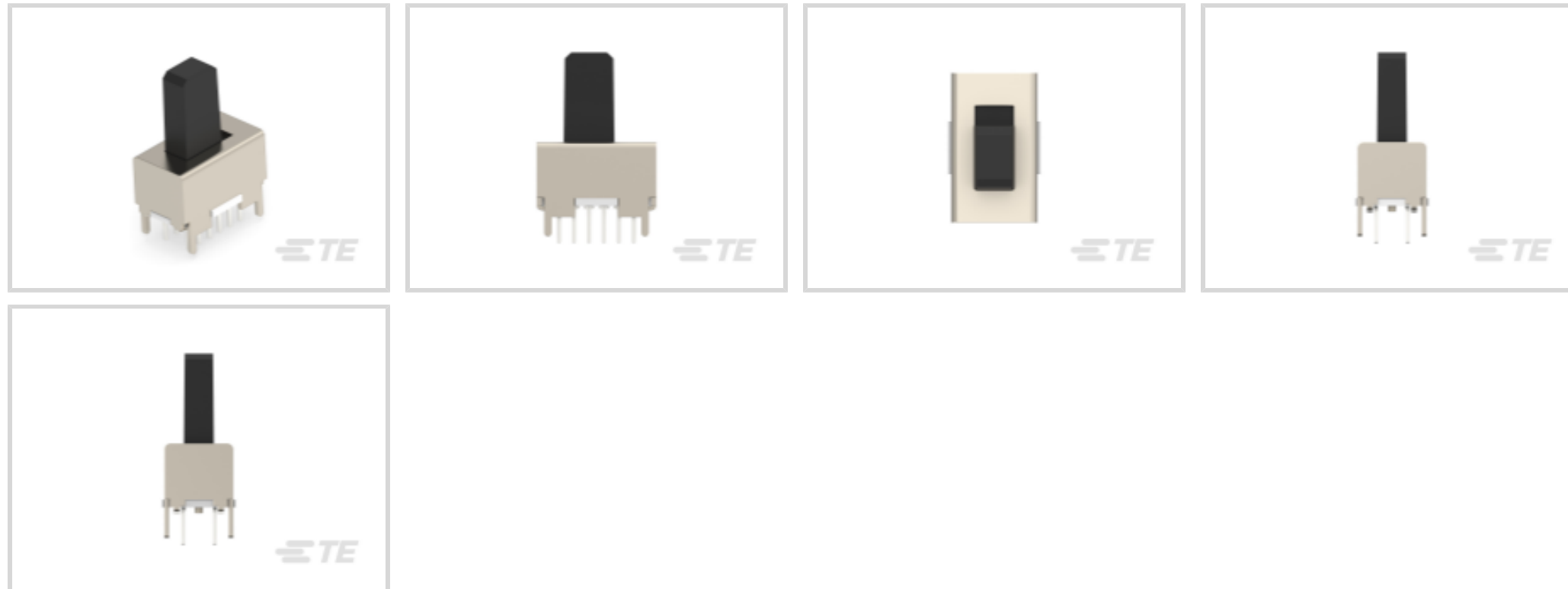

Configuration (Pole-Throw): **Four Pole - Double Throw**

Product Orientation: **Vertical**

Contact Base Material: **Copper Alloy**

Number of Actuators: **Single**

Number of Positions: **2**

Features

Configuration Features

Terminals Connected	1-2, 4-5, 7-8, 10-11
Configuration (Pole-Throw)	Four Pole - Double Throw
Number of Actuators	Single
Number of Positions	2
Operating Function	On On

Electrical Characteristics

Contact Current Rating	.3 A
Operating Voltage	125 VAC

Body Features

Actuator Orientation	Top
Actuator Travel	2 mm [.079 in]
Product Orientation	Vertical
Actuator Profile	Extended
Actuator Material	POM



Actuator Color	Black
----------------	-------

Contact Features

Contact Base Material	Copper Alloy
Switch Contact Plating Material	Silver

Termination Features

Termination Post & Tail Length	3.4 mm[.134 in]
Termination Method to Printed Circuit Board	Through Hole - Solder

Dimensions

Actuator Length	12 mm[.472 in]
Product Width	9.2 mm[.362 in]
Product Length	16 mm[.63 in]

Industry Standards

UL Flammability Rating	UL 94HB
------------------------	---------

Packaging Features

Packaging Method	Tray
------------------	------

Other

Grade	Instrumentation
-------	-----------------

Product Compliance

[For compliance documentation, visit the product page on TE.com>](#)

EU RoHS Directive 2011/65/EU	Compliant
EU ELV Directive 2000/53/EC	Compliant
China RoHS 2 Directive MIIT Order No 32, 2016	No Restricted Materials Above Threshold
EU REACH Regulation (EC) No. 1907/2006	Current ECHA Candidate List: JUNE 2024 (241) Candidate List Declared Against: JAN 2024 (240) Does not contain REACH SVHC
Halogen Content	Low Halogen - Br, Cl, F, I < 900 ppm per homogenous material. Also BFR/CFR/PVC Free
Solder Process Capability	Wave solder capable to 265°C

Product Compliance Disclaimer



This information is provided based on reasonable inquiry of our suppliers and represents our current actual knowledge based on the information they provided. This information is subject to change. The part numbers that TE has identified as EU RoHS compliant have a maximum concentration of 0.1% by weight in homogenous materials for lead, hexavalent chromium, mercury, PBB, PBDE, DBP, BBP, DEHP, DIBP, and 0.01% for cadmium, or qualify for an exemption to these limits as defined in the Annexes of Directive 2011/65/EU (RoHS2). Finished electrical and electronic equipment products will be CE marked as required by Directive 2011/65/EU. Components may not be CE marked. Additionally, the part numbers that TE has identified as EU ELV compliant have a maximum concentration of 0.1% by weight in homogenous materials for lead, hexavalent chromium, and mercury, and 0.01% for cadmium, or qualify for an exemption to these limits as defined in the Annexes of Directive 2000/53/EC (ELV). Regarding the REACH Regulation, the information TE provides on SVHC in articles for this part number is based on the latest European Chemicals Agency (ECHA) 'Guidance on requirements for substances in articles' posted at this URL: <https://echa.europa.eu/guidance-documents/guidance-on-reach>

Compatible Parts

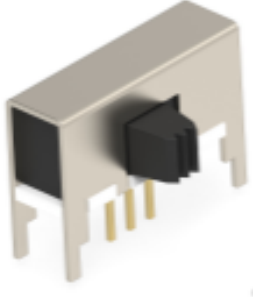

TE Part # 1825258-2
SPDT SL SW R/A AU



TE Part # 1825255-5
MHS12304=SPDT SL SW VERT AG



TE Part # 1825255-7
MHS13304=SP3T SL SW VERT AG



TE Part # 1825257-1
MSS120004=SPDT SL SW VERT AG



TE Part # 1825255-8
MHS133G04=SP3T SL SW VERT AU

Also in the Series | Alcoswitch MSS



Slide Switches(15)

Customers Also Bought

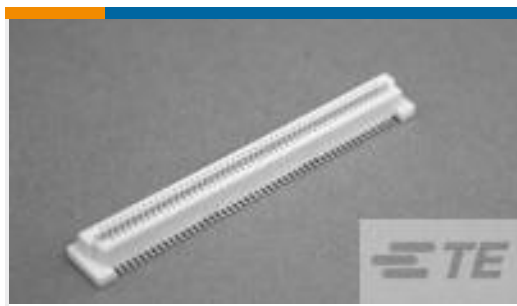

TE Part #5177983-8
0.8FH,R05H.5,160,08/Sn,TU



TE Part #414026-2
JACK ASSY,SMB,RT ANG



TE Part #5179029-8
0.8FH,P06H.5,160,08/Sn,TU



TE Part #5352069-1
Z-PACK/B25 RAF 125P

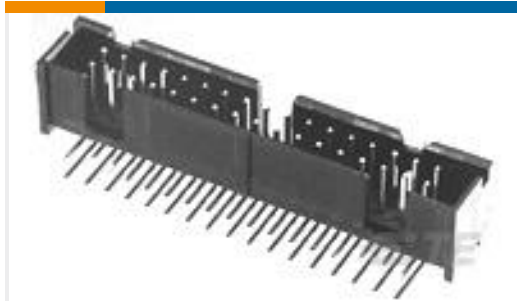

TE Part #5103310-6
A/L LOW PRO HDR 26P RA BLACK

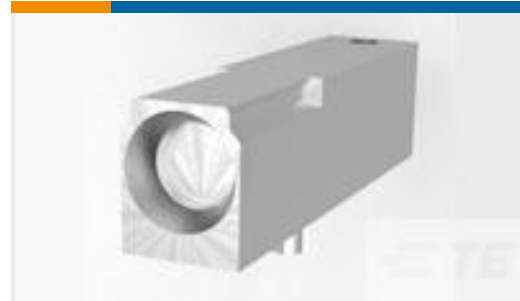

TE Part #5223957-1
UPM GUIDE MODULE



TE Part #61188-1
250 FASTON FLAG REC 16-12 AWG
TPBZ

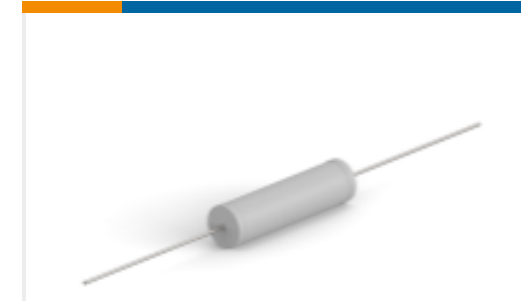

TE Part #7-2176414-2
7W STD M/OX 5% 18K

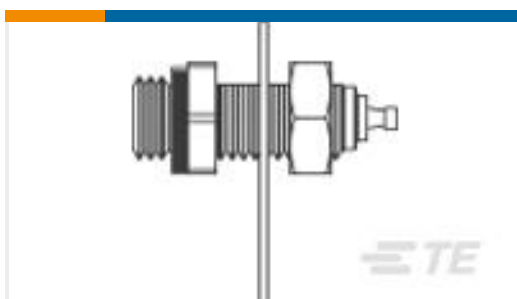

TE Part #1466288-1
031-0050-0001

Documents

Product Drawings

[MSS425004=4PDT SL SW AG](#)

English

CAD Files

[3D PDF](#)

3D

Customer View Model

[ENG_CVM_CVM_1825266-1_A.2d_dxf.zip](#)

English

Customer View Model

[ENG_CVM_CVM_1825266-1_A.3d_igs.zip](#)

English

Customer View Model

[ENG_CVM_CVM_1825266-1_A.3d_stp.zip](#)

English

By downloading the CAD file I accept and agree to the [Terms and Conditions](#) of use.

Datasheets & Catalog Pages

1825266-1

Slide Switches, Four Pole - Double Throw Configuration (Pole-Throw), Vertical,
Copper Alloy, Single Actuator, 2 Position, On On, Alcoswitch MSS



SWITCHES_CORE_PROGRAM_CATALOG

English