

30 MICA VP3

Micromodul™ connectors, pitch 1.27 mm



Micromodul™ connector for indirect mating, insulation displacement technology (IDT), with lock MICA: loose, on reel

Approvals:



30 MICA VP3

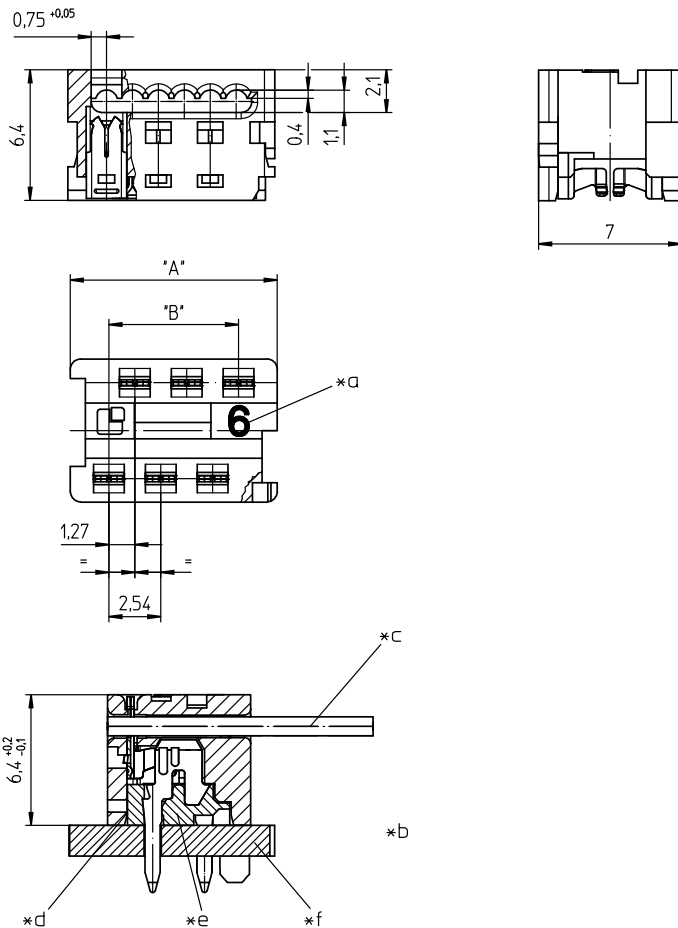

MICA A VP3

MICA C VP3

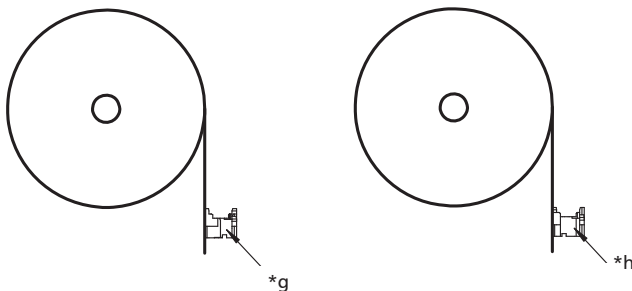

Environmental conditions

Temperature range -40 °C/+120 °C¹

¹ upper limit temperature (insulating body) RTI (electrical) of the UL Yellow Card

Materials

Insulating body PBT GF, V-0 according to UL94
Contact spring CuSn, tin-plated – MICA
CuSn, gold-plated in contact area, tin-plated in insulation displacement area – MICA SEL 0,8 AU

Mechanical data

Insertion force/contact ≤ 1.5 N
Withdrawal force/contact > 0.4 N





Connectable conductors for IDT area

Construction flat cable 1.27 mm LiYV
Section min. AWG 28 (0.09 mm²)
Section max. AWG 26 (0.14 mm²)
Insulation diameter 1.0 mm
Approved cables at www.lumberg.com 

Electrical data (at T_{amb} 20 °C)

Contact resistance ≤ 10 mΩ
Rated current 1.2 A
Rated voltage 32 V AC
(250 V AC not considering clearances and creepage distances of IEC 60664/DIN EN 60664)
Material group IIIa (IEC)/3 (UL) (CTI ≥ 175)
Creepage distance 0.54 mm
Clearance 0.54 mm
Insulation resistance > 1 GΩ

Associated products

Accessories
 AZ30
Harnessing equipment
 HA3...e  HA30e-R  VARICON 1000
 VARICON 1000-Eco

-
- *a marking: number of poles
 - *b connector mated with tab header
 - *c flat cable
 - *d locking
 - *e tab header MICS...
 - *f printed circuit board
 - *g narrow keying groove
 - *h wide keying groove

30 MICA VP3

Designation	Pole Number	PU (Pieces)	MDQ (Pieces)	Dimensions	
				A (mm)	B (mm)
MICA 04 A VP3	4	4000	4000	7.59	3.81
MICA 06 A VP3	6	4000	4000	10.13	6.35
MICA 08 A VP3	8	4000	4000	12.67	8.89
MICA 10 A VP3	10	4000	4000	15.21	11.43
MICA 12 A VP3	12	4000	4000	17.75	13.97
MICA 14 A VP3	14	4000	4000	20.29	16.51
MICA 16 A VP3	16	4000	4000	22.83	19.05
MICA 18 A VP3	18	4000	4000	25.37	21.59
MICA 20 A VP3	20	4000	4000	27.91	24.13
MICA 26 A VP3	26	4000	4000	35.53	31.75
MICA 04 C VP3	4	4000	4000	7.59	3.81
MICA 06 C VP3	6	4000	4000	10.13	6.35
MICA 08 C VP3	8	4000	4000	12.67	8.89
MICA 10 C VP3	10	4000	4000	15.21	11.43
MICA 12 C VP3	12	4000	4000	17.75	13.97
MICA 14 C VP3	14	4000	4000	20.29	16.51
MICA 16 C VP3	16	4000	4000	22.83	19.05
MICA 18 C VP3	18	4000	4000	25.37	21.59
MICA 20 C VP3	20	4000	4000	27.91	24.13
MICA 26 C VP3	26	4000	4000	35.53	31.75

Packaging:

on reel

for other packaging options see separate item MICA