

# MDS Medical AC-DC Adapter

## 24Volt, 60Watt / MDS-060AAS24 B



# 060AAS24 B

### Highlights & Features

- Meet DOE Level VI and ErP Lot 7
- Safety Approvals to IEC 60601-1 3.1rd ed. & IEC 60950-1
- Compliant with IEC 60601-1-2 4th Ed. Requirements
- Low touch current (<0.1mA Normal & <0.3mA single fault)
- Over-Voltage/Load/Temperature & Short Circuit protections
- 1 Million Hours MTBF
- 2 × MOPP isolation
- 3 years warranty

### Safety Standards



CB Certified for worldwide use

|                                |                                      |
|--------------------------------|--------------------------------------|
| <b>Model Number:</b>           | MDS-060AAS24 B                       |
| <b>Unit Weight:</b>            | 360 grams (12.7 ounces)              |
| <b>Dimensions (W x L x H):</b> | 62.0x135.0x34.1 mm<br>2.4x5.3x1.3 in |

### General Description

The MDS series of external power supply come with universal AC input at 90Vac to 275Vac. Other features include low earth leakage, risk management report available and the electric shock protection comply with 2 x MOPP. The MDS series is certified for EMC standards according to EN 55011 for industrial, scientific and medical (ISM) radio-frequency equipment and EN 55032 for Information Technology Equipment (ITE) radio-frequency equipment. In addition, only recognized Japanese capacitors are used.

The MDS series come with both medical and ITE safety approvals including UL/cUL/CCC/CE and CB certification and are fully compliant with RoHS Directive 2011/65/EU for environmental protection.

### Model Information

#### Medical AC-DC Adapter

| Model Number   | Input Voltage Range | Output Voltage | Output Current |
|----------------|---------------------|----------------|----------------|
| MDS-060AAS24 B | 90-275Vac           | 24Vdc          | 2.5A           |

### Model Numbering

|                                                         |   |                                                                                                            |                                          |                                                                              |          |
|---------------------------------------------------------|---|------------------------------------------------------------------------------------------------------------|------------------------------------------|------------------------------------------------------------------------------|----------|
| <b>MDS</b><br><small>Delta Medical power Supply</small> | - | <b>060</b><br><small>Max wattage in the product series. Maybe lower at some voltage.<br/>060 → 60W</small> | <b>AAS</b><br><small>Family Code</small> | <b>24</b><br><small>Output Voltage<br/>Single Output:<br/>24 for 24V</small> | <b>B</b> |
|---------------------------------------------------------|---|------------------------------------------------------------------------------------------------------------|------------------------------------------|------------------------------------------------------------------------------|----------|

# MDS Medical AC-DC Adapter

## 24Volt, 60Watt / MDS-060AAS24 B

### Specifications

#### Input Ratings / Characteristics

|                             |                                                                    |
|-----------------------------|--------------------------------------------------------------------|
| Nominal Input Voltage       | 100-250Vac                                                         |
| Input Voltage Range         | 90-275Vac                                                          |
| Nominal Input Frequency     | 50-60Hz                                                            |
| Input Frequency Range       | 47-63Hz                                                            |
| Input Current (max)         | 1.5A @ 115Vac, 0.75A @ 230Vac                                      |
| Efficiency (typ.)           | 88.3%, Reference Fig.1                                             |
| Average Efficiency (min)    | 88% @ 115Vac and 87% @ 230Vac                                      |
| Standby Power (max)         | 0.21W @ 115Vac and 0.5W @ 230Vac                                   |
| Inrush Current (typ.)       | 50A @ 115Vac, 100A @ 230Vac                                        |
| Touch Current (max)         | 0.1mA @ 275Vac NC <sup>1)</sup> , 0.3mA @ 275Vac SFC <sup>2)</sup> |
| Earth Leakage Current (max) | 0.1mA @ 275Vac NC <sup>1)</sup> , 0.3mA @ 275Vac SFC <sup>2)</sup> |

1) NC: normal condition

2) SFC: single fault condition

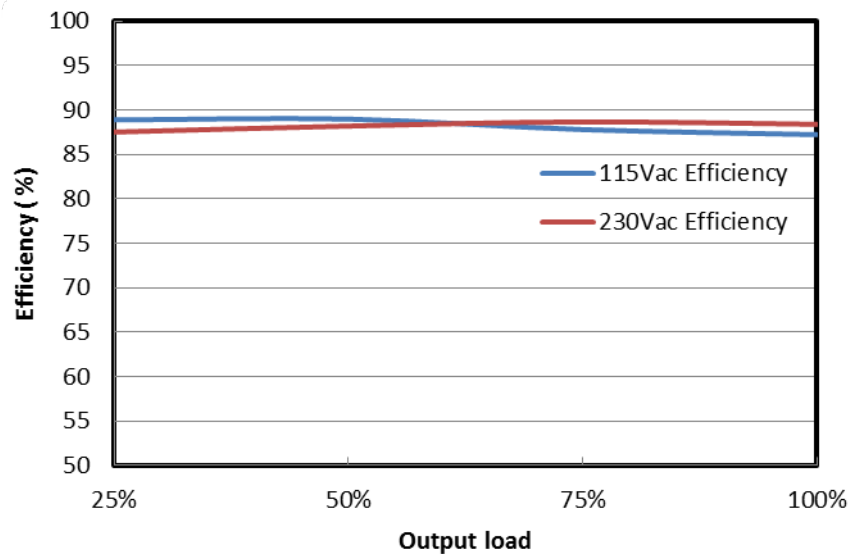

Fig.1 Efficiency versus output load

#### Output Ratings / Characteristics

|                                                       |                                          |
|-------------------------------------------------------|------------------------------------------|
| Nominal Output Voltage                                | 24Vdc                                    |
| Total regulation                                      | ± 5%                                     |
| Output Current                                        | 2.5A                                     |
| Output Power                                          | 60W                                      |
| Line Regulation (max)                                 | ± 0.5%                                   |
| Load Regulation (max)                                 | ± 4.5%                                   |
| Ripple & Noise (typ.)                                 | 43mV pk-pk @ Full load, Reference Fig. 2 |
| Start-up Time (max)                                   | 3000ms @ 115Vac                          |
| Hold-up Time (min)                                    | 10ms @ 115Vac                            |
| Dynamic Response (Overshoot & Undershoot O/P Voltage) | ± 5% @ 50-100% load                      |
| Capacitive load (max)                                 | 3300uF                                   |

\*Periodic and Random Deviation

# MDS Medical AC-DC Adapter

## 24Volt, 60Watt / MDS-060AAS24 B

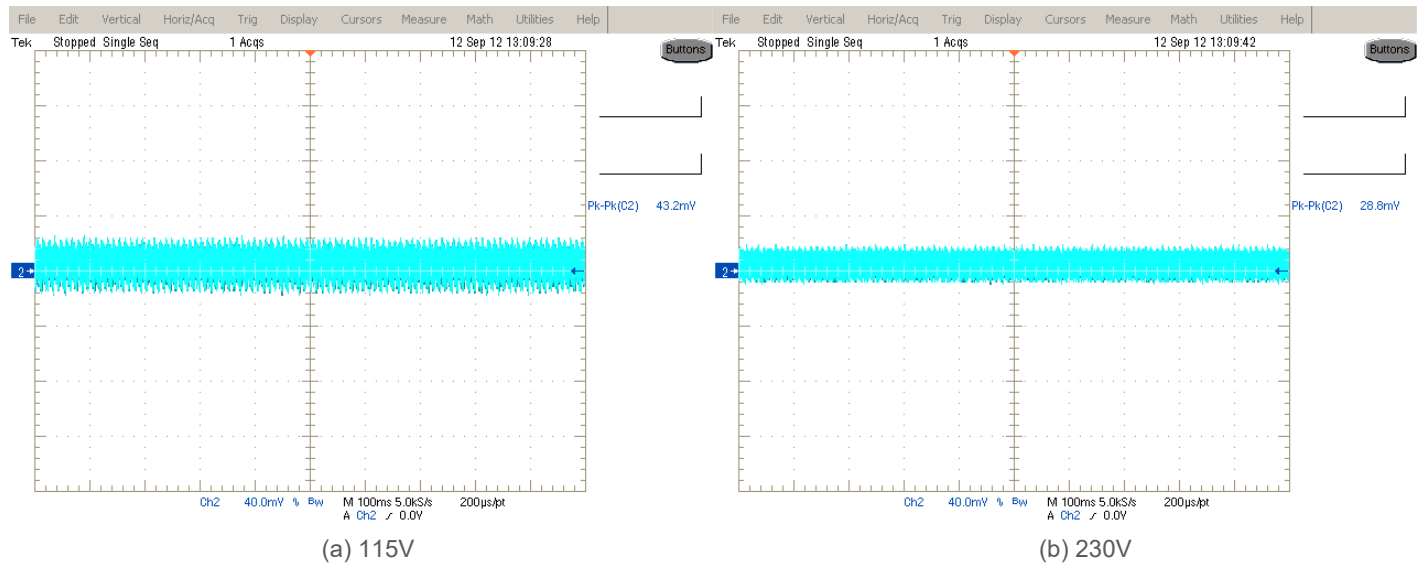
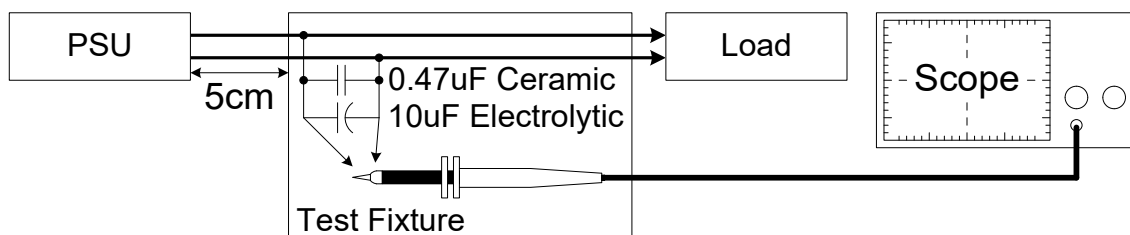

Fig. 2 Ripple & Noise example, 20MHz BW

### Ripple & Noise measurement circuit



### Mechanical

|                       |                                                                        |
|-----------------------|------------------------------------------------------------------------|
| Case Chassis          | PC                                                                     |
| Case Cover            | PC                                                                     |
| Dimensions(W x L x H) | 62.0 x 135.0 x 34.1 mm (2.4x5.3x1.3 in)                                |
| Unit Weight           | 360 grams (12.7 ounces)                                                |
| Indicator             | LED                                                                    |
| Terminal              | Input: C14 socket<br>Output: 4pin Din / Barrel type / Tuning fork type |

### Environment

|                             |           |                                                  |
|-----------------------------|-----------|--------------------------------------------------|
| Surrounding Air Temperature | Operating | 0°C to +40°C                                     |
|                             | Storage   | -40°C to +85°C                                   |
| Operating Humidity          |           | 10-95% RH (Non-Condensing)                       |
| Operating Altitude          |           | 3,000 meters (9,840 feet)                        |
| Shock Test (Non-Operating)  |           | 50G, 11ms, 3 shocks for each direction           |
| Vibration (Non-Operating)   |           | 5-500Hz, 2.09Grms, 20 minute for each three axis |

# MDS Medical AC-DC Adapter

## 24Volt, 60Watt / MDS-060AAS24 B

### Protections

|                                |                                                                        |
|--------------------------------|------------------------------------------------------------------------|
| Overvoltage (max)              | 150%, Latch Mode                                                       |
| Over load / Over current (max) | 180% of rated load current, Hiccup Mode, (Non-Latching, Auto-Recovery) |
| Over Temperature               | Hiccup Mode, (Non-Latching, Auto-Recovery)                             |
| Short Circuit                  | Hiccup Mode, (Non-Latching, Auto-Recovery)                             |
| Protection Against Shock       | Class I                                                                |

### Reliability Data

|             |                                            |
|-------------|--------------------------------------------|
| MTBF (typ.) | 1 million Hours based on Telecordia SR-332 |
|-------------|--------------------------------------------|

### Safety Standards / Directives

|                    |                                                                                                                                                                                                                      |          |
|--------------------|----------------------------------------------------------------------------------------------------------------------------------------------------------------------------------------------------------------------|----------|
| Medical Safety     | IEC60601-1 3 <sup>rd</sup> and 3.1 <sup>rd</sup> edition CB report<br>IEC60601-1 edition 3.1 <sup>rd</sup> (2012), EN60601-1 (2006) + A11 + A1 + A12, CAN/CSA-C22.2 NO. 60601-1:14, ANSI/AAMI ES60601-1:2005/(R)2012 |          |
| ITE Safety         | IEC60950-1 (Ed.2,2005), GB4943.1-2011, GB9254-2008, GB17625.1-2003                                                                                                                                                   |          |
| CE                 | MDD Directive 93/42/EEC                                                                                                                                                                                              |          |
| Material and Parts | RoHS Directive 2011/65/EU Compliant                                                                                                                                                                                  |          |
| Galvanic Isolation | Input to Output                                                                                                                                                                                                      | 4000 Vac |
|                    | Input to Ground                                                                                                                                                                                                      | 1500 Vac |
|                    | Output to Ground                                                                                                                                                                                                     | 500 Vac  |

# MDS Medical AC-DC Adapter

## 24Volt, 60Watt / MDS-060AAS24 B

### EMC (Compliant with IEC 60601-1-2 4th Ed. Requirements)

|                                   |               |                                                                                                                                                                                                                                                                                                                                                     |
|-----------------------------------|---------------|-----------------------------------------------------------------------------------------------------------------------------------------------------------------------------------------------------------------------------------------------------------------------------------------------------------------------------------------------------|
| EMC / Emissions                   |               | EN55011/EN55032,FCC Title 47:Class B                                                                                                                                                                                                                                                                                                                |
| Harmonic Current Emissions        | IEC61000-3-2  | Meet Class A limit                                                                                                                                                                                                                                                                                                                                  |
| Immunity to                       |               |                                                                                                                                                                                                                                                                                                                                                     |
| Voltage Flicker                   | IEC61000-3-3  |                                                                                                                                                                                                                                                                                                                                                     |
| Electrostatic Discharge           | IEC61000-4-2  | Level 4 Criteria A <sup>1)</sup><br>Air Discharge: 15kV<br>Contact Discharge: 8kV                                                                                                                                                                                                                                                                   |
| Radiated Field                    | IEC61000-4-3  | Criteria A <sup>1)</sup><br>80MHz-2700MHz, 10V/m AM modulation<br>385MHz-5785MHz, 28V/m Pulse mode and other modulation                                                                                                                                                                                                                             |
| Electrical Fast Transient / Burst | IEC61000-4-4  | Level 3 Criteria A <sup>1)</sup> :2kV                                                                                                                                                                                                                                                                                                               |
| Surge                             | IEC61000-4-5  | Level 3 Criteria A <sup>1)</sup><br>Common Mode <sup>3)</sup> : 2kV<br>Differential Mode <sup>4)</sup> : 1kV                                                                                                                                                                                                                                        |
| Conducted                         | IEC61000-4-6  | Level 2 Criteria A <sup>1)</sup><br>150kHz-80MHz, 3Vrms, 6Vrms at ISM bands and Amateur radio bands                                                                                                                                                                                                                                                 |
| Power Frequency Magnetic Fields   | IEC61000-4-8  | Criteria A <sup>1)</sup><br>Magnetic field strength 30A/m                                                                                                                                                                                                                                                                                           |
| Voltage Dips                      | IEC61000-4-11 | Criteria A <sup>1)</sup><br>0% U <sub>r</sub> , 0.5 cycle (10ms)<br>, 0°/45°/90°/135°/180°/225°/270°/315°/360°<br><br>Criteria B <sup>2)</sup><br>0% U <sub>r</sub> , 1 cycle (20ms), 0°<br><br>Criteria A <sup>1)</sup><br>70% U <sub>r</sub> , 25 cycle (500ms), 0°<br><br>Criteria B <sup>2)</sup><br>0% U <sub>r</sub> , 250 cycle (5000ms), 0° |

1) Criteria A: Normal performance within the specification limits

2) Criteria B: Output out of regulation, or shuts down during test. Automatically restore to normal operation after test.

3) Asymmetrical: Common mode (Line to earth)

4) Symmetrical: Differential mode (Line to line)

# MDS Medical AC-DC Adapter

## 24Volt, 60Watt / MDS-060AAS24 B

### Block Diagram

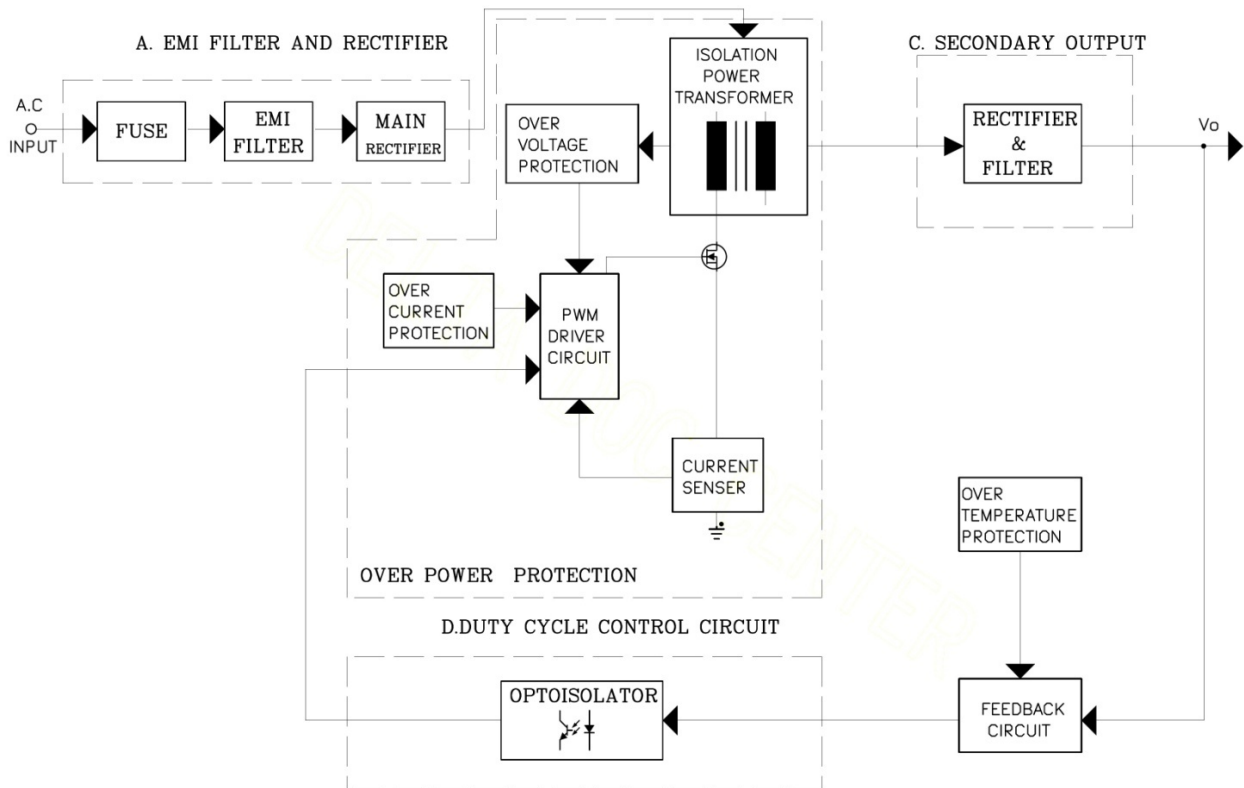

# MDS Medical AC-DC Adapter

## 24Volt, 60Watt / MDS-060AAS24 B

### Dimensions

W x L x H: 62.0 x 135 x 34.1 mm

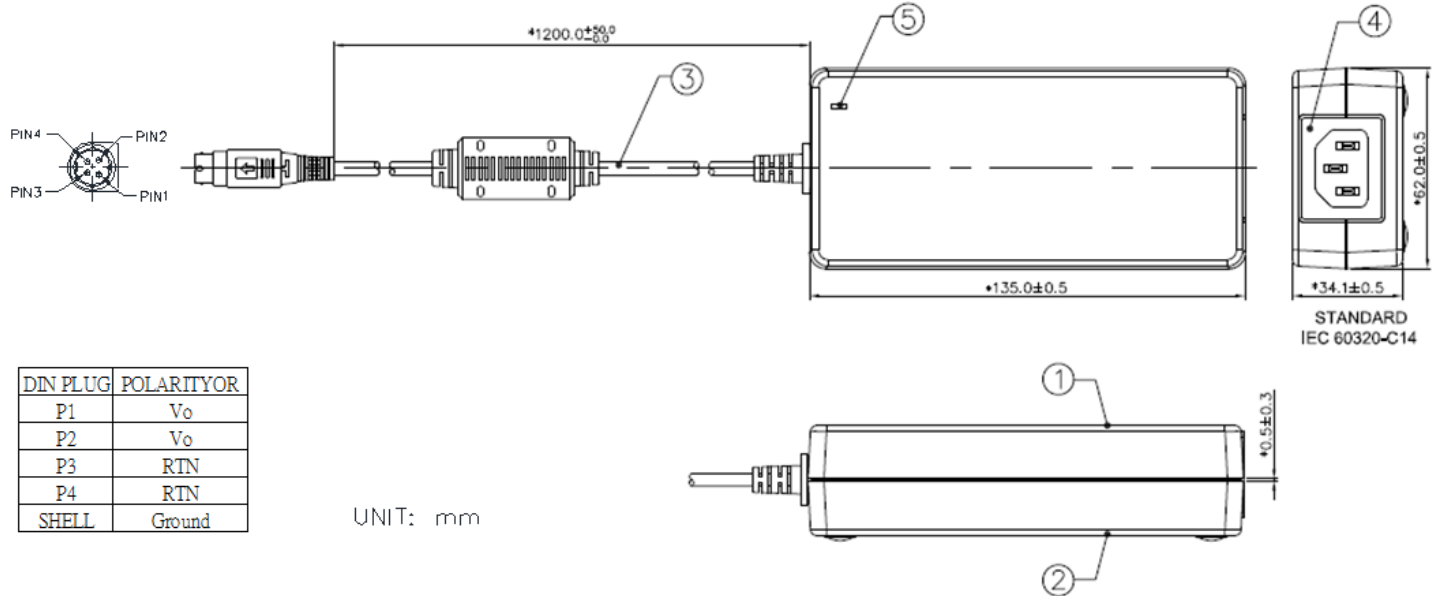

| Item | Device Description     |
|------|------------------------|
| 1    | Cover                  |
| 2    | Chassis                |
| 3    | Power Cord             |
| 4    | Socket (IEC60320, C14) |
| 5    | Lens                   |

# MDS Medical AC-DC Adapter

## 24Volt, 60Watt / MDS-060AAS24 B

### Functions

#### Start-up Time

The time required for the output voltage ( $V_o$ ) to reach 90% of its set value, after the input AC voltage is applied.

#### Rise Time

The time required for the output voltage ( $V_o$ ) to change from 10% to 90% of its steady state value.

#### Hold-up Time

Hold up time is the time when the AC input collapses and output voltage retains regulation for a certain period of time. The time required for the output to reach 95% of its set value, after the input voltage is removed.

#### ■ Graph illustrating the Start-up Time, Rise Time, and Hold-up Time

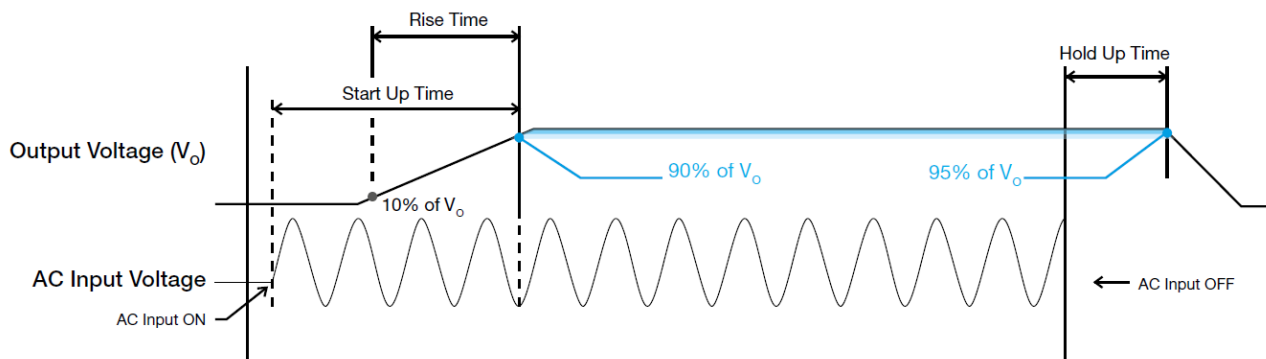

# MDS Medical AC-DC Adapter

## 24Volt, 60Watt / MDS-060AAS24 B

### Dynamic Response

The power supply output voltage will remain within  $\pm 3\%$  of its steady state value, when subjected to a dynamic load change from 50 to 100% of its rated current.

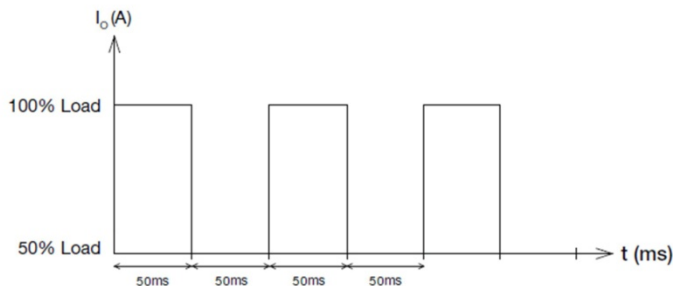

### Inrush Current

Inrush current is the input current that occurs when the input voltage is first applied. For AC input voltages, the maximum peak value of inrush current will occur during the first half cycle of the applied AC voltage. This peak value decreases exponentially during subsequent cycles of AC voltage.

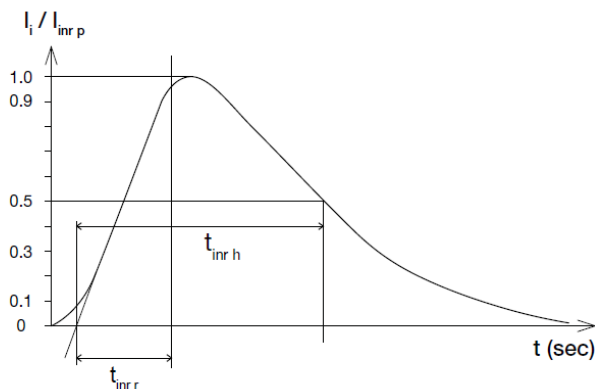

### Overvoltage Protection

The power supply's overvoltage circuit will be activated when its internal feedback circuit fails. The output voltage shall not exceed its specifications defined on Page 4 under "Protections". Power supply will latch off, and require removal/re-application of input AC voltage in order to restart.

### Short Circuit Protection

The power supply's output OLP/OCP function also provides protection against short circuits. When a short circuit is applied, the output current will operate in "Hiccup mode", as shown in the illustration in the OLP/OCP section on this page. The power supply will return to normal operation after the short circuit is removed.

### Overload & Over current Protections

The power supply's Overload (OLP) and Over current (OCP) Protections will be activated when output current is between 110% and 130% of  $I_o$  (Max load). Upon such an occurrence,  $V_o$  will start to drop. Once the power supply has reached its maximum power limit, the protection will be activated, and the power supply will go into "Hiccup mode" (Auto-Recovery). The power supply will recover once the fault condition causing the OLP and OCP is removed and  $I_o$  is back within the specified limit.

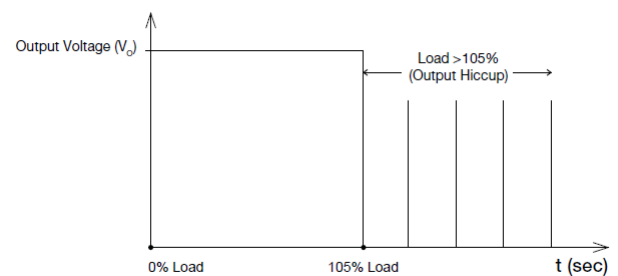

Additionally, if the  $I_o$  is  $< 130\%$  but  $> 110\%$  for a prolonged period of time (depending on the load), the Over Temperature Protection (OTP) will be activated due to high temperature on critical components. The power supply will then go into hiccup mode until the fault is removed; and, the input voltage is removed, then reapplied.

### Over Temperature Protection

As mentioned above, the power supply also has Over Temperature Protection (OTP). This is activated when the overload condition persists for an extended duration and the output current is below the overload trigger point but  $> 100\%$  load. In the event of a higher operating condition at 100% load, the power supply will run into OTP when the surrounding air temperature is higher than the operating temperature. When activated, the output voltage will go into hiccup mode until the input voltage is removed; then, reapplied, and the surrounding air temperature drops to its normal operating temperature.

# MDS Medical AC-DC Adapter

## 24Volt, 60Watt / MDS-060AAS24 B

### Certificate



All Delta Medical Power products conform to the European directive 2011/65/EU. RoHS is the abbreviation for "Restriction of the use of certain hazardous substances."



Delta has been certified as meeting the requirement of ISO 13485: 2003 and EN ISO 13485:2012 for the design and manufacture of switching power supply and adaptor for medical device.



Delta is approved for the UL Total Certification Program (TCP) approved client laboratory for IEC60950 and IEC60065. Delta also has participated UL Client Test Data Program (CTDP) for IEC 60601.



Meet DOE Level VI and ErP Lot 7 Efficiency Requirement

### Attention

Delta provides all information in the datasheets on an "AS IS" basis and does not offer any kind of warranty through the information for using the product. In the event of any discrepancy between the information in the catalog and datasheets, the datasheets shall prevail (please refer to [www.DeltaPSU.com](http://www.DeltaPSU.com) for the latest datasheets information). Delta shall have no liability of indemnification for any claim or action arising from any error for the provided information in the datasheets. Customer shall take its responsibility for evaluation of using the product before placing an order with Delta.

Delta reserves the right to make changes to the information described in the datasheets without notice.