

## DATA SHEET

Side Mount, Stainless Steel

### M5900 Series



## Custom Configurations

Contact us directly for custom solutions.

Email: [info@madisonco.com](mailto:info@madisonco.com)

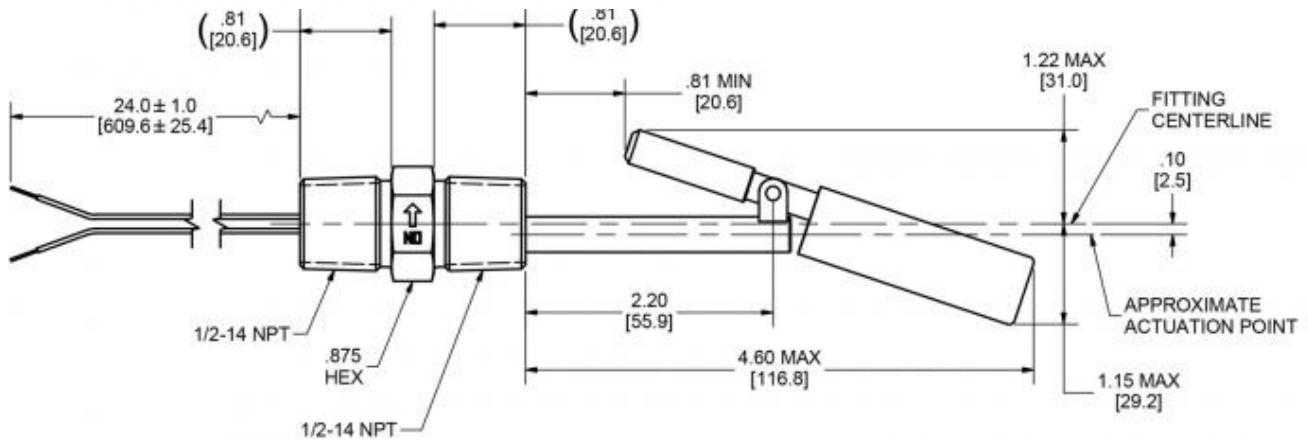

Well-suited for corrosive environments, as well as food processing, medical, heating, and cooling applications. This series of stainless steel side-mounted float switches are among the most durable float switches in the industry.

### Applicable Industries

- Food-grade fluid level control
- Hot water boilers and steam generator tanks
- Chemical tanks, fuel tanks and other hazardous locations

### Features

- High-pressure and high-temperature industrial tank level control
- Available with extended stem lengths

### Material



- Stem and Float: 316 Stainless Steel

### Specifications

- Max. temperature: 392°F / 200°C
- Max. pressure: 300 psi
- Switch rating: 30 watt, SPST

### Electrical Ratings

- 240V AC, 0.14A; 120V AC, 0.28A;  
120V DC, 0.07A; 24V DC, 0.28A

| Part Numbers  | Mounting        | Minimum Media SG | Lead Wires                               | Approvals                            |
|---|-----------------|------------------|--|--------------------------------------|
| M5900  | 1" x 1/2" NPT   | 0.75             | 24", 22 AWG, Teflon Insulated (standard) | CE, UL Haz. Loc., CSA Haz. Loc., NSF |
| M5910  | 1/2" x 1/4" NPT | 0.75             | 24", 22 AWG, Teflon Insulated (standard) | CE, UL Haz. Loc., CSA Haz. Loc., NSF |
| M5920  | 1/2" x 1/2" NPT | 0.75             | 24", 22 AWG, Teflon Insulated (standard) | CE, UL Haz. Loc., CSA Haz. Loc., NSF |

NOTE: Other fittings and voltages are available. [Contact us](#) to discuss your application.

### Level Switch Electrical Considerations and Reed Switch Protection

When using Madison level switches, it is important to consider the application’s electrical parameters. Our level switches utilize reed switch technology, which are glass encapsulated, magnetically actuated switches. Madison generally provides electrical ratings for resistive loads; however, where the maximum current of the load permits, the switches are capable of controlling devices such as motors, solenoids or coils that produce capacitive or inductive electrical loads. Where possible, Madison recommends the use of general-purpose/isolation relays or controllers to protect the switch.

### Protect your level switch: Protection Techniques and Common Failure Modes

Reed Switch protection is the most successful method of increasing the performance and life of your level sensor. Since every application varies, it is important to understand your protection options. The life of the reed switch is typically 1 million cycles, within rated load conditions. The table below is a guide to suggested protection techniques and common failure modes associated with each load type.

| Load   | Load Example  | Protection                   | Diagram | Common Failure Modes        | Failure Mode Description  |
|--|---|------------------------------|---------|-----------------------------|---|
| Resistive (DC)                               | Indicator Lamp, Heaters                               | Current Limiting Resistor    | A       | In-rush Current (Switching) | In-rush current exceeds rating and welds switch closed                    |
|  |   |                              |         | Over-Current (Carry)        | Carry-current exceeds rating and switch welds or burns open like a fuse   |
| Inductive & Capacitive (DC)                  | Relay Coil, Solenoids, Motor                          | Reversing Diode              | B       | Over-Voltage (Arcing)       | Voltage arcing during switching welds contacts closed                     |
| Inductive & Capacitive (AC or DC)            |   | Resistor & Capacitor Network | C       |                             |   |
| Resistive, Inductive & Capacitive (AC or DC) | Indicator Lamp, Heaters, Relay Coil, Solenoids, Motor | Varistor or MOV              | D       | Over-Voltage (Arcing)       | Transients voltage spikes exceed breakdown voltage and weld switch closed |

#### Capacitive Load

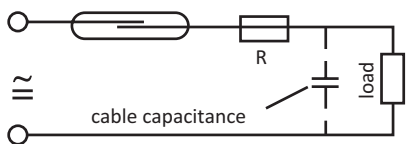

Diagram A: Current Limiting Resistor

#### Inductive Load

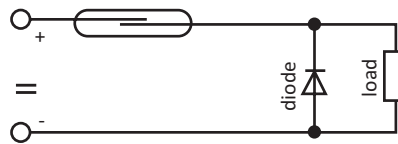

Diagram B: Reversing Diode

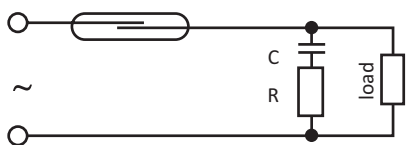

Diagram C: RC Network

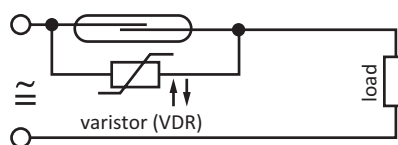

Diagram D: Varistor or MOV

For DC circuits: Insert a 1N4004 diode across the load (i.e.: relay coil) with the cathode end (marked with circular line) connected toward the positive side. This way the diode conducts only when the field collapses. General rule is to use a diode with a voltage rating at least three times the circuit voltage. A 1N4004 has a rating of 1 amp continuous, 30 amp surge, 400V max. Refer to diagram B.

For typical 120V AC circuits: Insert a 50 to 100 ohm, 1/2 watt Resistor in series with a .1 micro farad 400 to 600 volt capacitor across the switch. The capacitor is a high impedance to 60 hertz, but is essentially a short circuit to high frequencies of generated voltages. Alternately, a varistor V130LA10A by itself across the switch will also work for 120V AC. Refer to diagram D.



Madison Company | Sensing Solutions since 1959

27 Business Park Drive  
Branford, CT 06405 USA

Toll-Free: 800.466.5383  
Outside the USA: +1.203.488.4477

www.madisonsensors.com

