

KEMET Part Number: M39014/02-1360
(C062T474K5X5CS, CKR06BX474KS)

LDD Mil X7R PRF39014, Ceramic, Military/High Reliability, 0.47 uF, 10%, 50 VDC, BX, S (0.001%/1000 Hrs), Lead Spacing = 5.08mm

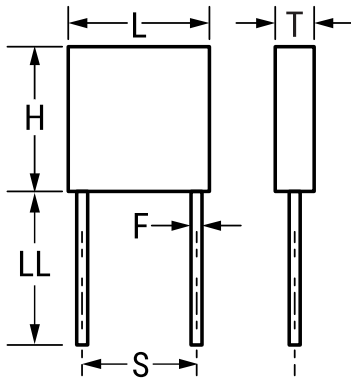

Dimensions	
L	7.37mm +/-0.25mm
H	7.37mm +/-0.25mm
T	2.29mm +/-0.25mm
S	5.08mm +/-0.38mm
LL	31.75mm MIN
F	0.635mm +/-0.051mm

Packaging Specifications	
Packaging:	Bulk, Bag
Packaging Quantity:	100

General Information	
Supplier:	KEMET
Series:	LDD Mil X7R PRF39014
Style:	Radial
RoHS:	No
Prop 65:	⚠ WARNING: Cancer and reproductive harm - www.p65warnings.ca.gov .
REACH:	SVHC (Pb - CAS 7439-92-1)
Termination:	Lead (SnPb)
Failure Rate:	S (0.001%/1000 Hrs)
Testing and Reliability:	MIL-PRF-39014
Qualifications:	MIL-PRF-39014
Notes:	Lead Length Shown Is For Parts Supplied In Bulk, See Packaging Specifications For Lead Lengths When Not Provided In Bulk

Specifications	
Capacitance:	0.47 uF
Capacitance Tolerance:	10%
Voltage DC:	50 VDC
Dielectric Withstanding Voltage:	125 V
Temperature Range:	-55/+125C
Temperature Coefficient:	BX
Dissipation Factor:	2.50%
Insulation Resistance:	2.1 GOhms