



# Photocoupler

## Product Data Sheet

### LTV354TA-V-36

Spec No.: DS70-2014-0077

Effective Date: 10/24/2014

Revision: -

**LITE-ON DCC**

**RELEASE**

BNS-OD-FC001/A4

## Photocouplers LTV354TA-V-36 series

### 1. DESCRIPTION

#### 1.1 Features

- AC input response
- Current transfer ratio ( CTR : MIN. 50% at  $I_F = \pm 1\text{mA}$ ,  $V_{CE} = 5\text{V}$  )
- Current transfer ratio ( CTR : 50% ~ 150% at  $I_F = \pm 1\text{mA}$ ,  $V_{CE} = 5\text{V}$  )
- High input-output isolation voltage (  $V_{iso} = 3,750\text{Vrms}$  )
- Subminiature type (The volume is smaller than that of conventional DIP type by as far as 30%)
- Mini-flat package : 2.0mm profile : LTV-354T series
- Safety approval
  - UL 1577 & cUL
  - VDE DIN EN60747-5-5 (VDE 0884-5) ,
  - CSA CA5A
  - FIMKO/DEMKO/SEMKO/NEMKO
- RoHS Compliance
  - All materials be used in device are followed EU RoHS directive (No.2002/95/EC).
- ESD pass HBM 8000V/ MM2000V /CDM2000V
- MSL class1

#### 1.2 Applications

- Hybrid substrates that require high density mounting.
- Programmable controllers
- System appliance, measuring instruments

# Photocouplers LTV354TA-V-36 series

## 2. PACKAGE DIMENSIONS

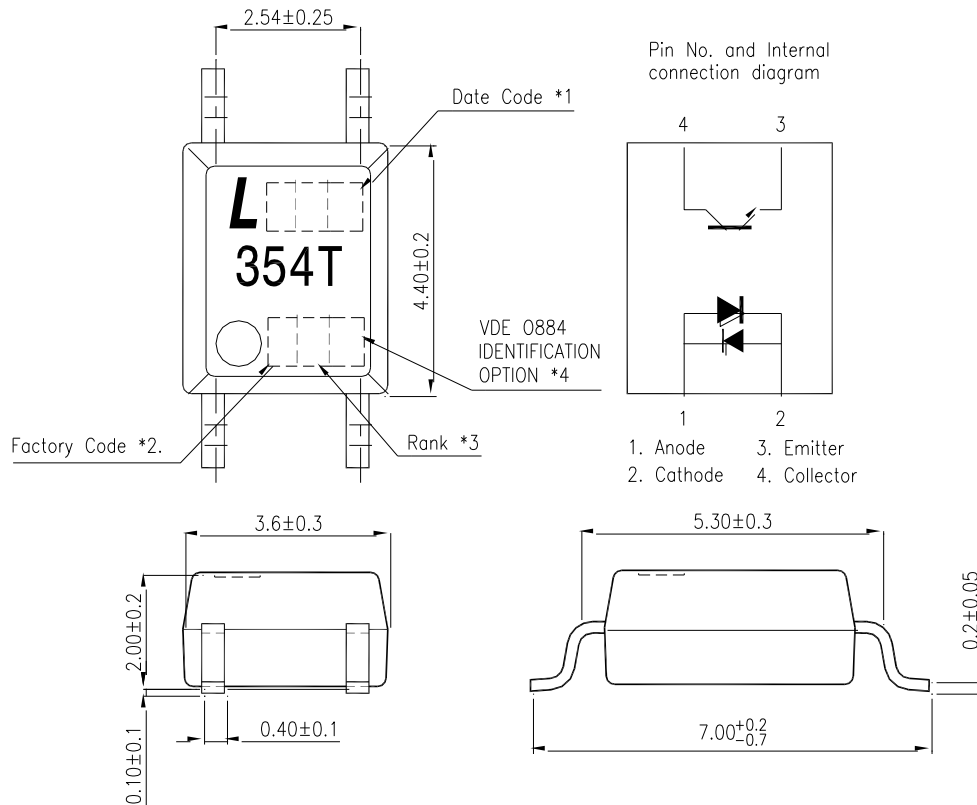

Part No : LTV354TA-V-36

### Notes :

1. 3-digit date code.
2. Factory identification mark shall be marked (W: China-CZ, X: China-TJ, Y: Thailand)
3. Rank shall be or shall not be marked.
4. "●" for halogen free option.
5. "4" or "V" for VDE option.

# Photocouplers LTV354TA-V-36 series

## 3. TAPING DIMENSIONS

P/N : LTV354TA-V-36

**TP1 MINI FLAT (3000pcs/reel): No Suffix & Suffix "TP1"**

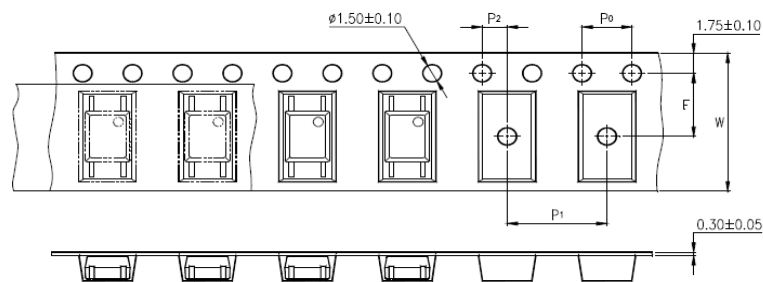

**TP MINI FLAT (3000pcs/reel) : Suffix "-TP"**

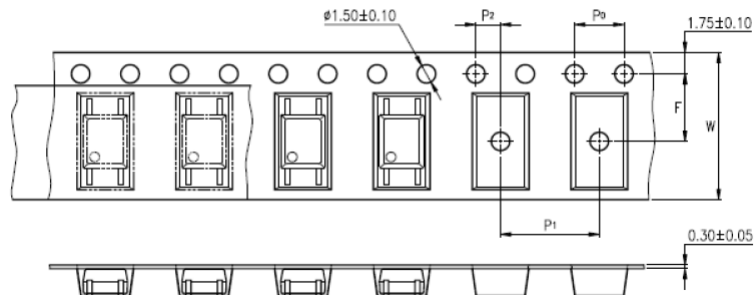

| Description                            | Symbol         | Dimension in mm (inch) |
|--|----------------|------------------------|
| Tape wide                              | W              | 12±0.3 (0.47)          |
| Pitch of sprocket holes                | P <sub>0</sub> | 4±0.1 (0.15)           |
| Distance of compartment                | F              | 5.5±0.1 (0.217)        |
|  | P <sub>2</sub> | 2±0.1 (0.079)          |
| Distance of compartment to compartment | P <sub>1</sub> | 8±0.1 (0.315)          |

## Photocouplers LTV354TA-V-36 series

### 4. RATING AND CHARACTERISTICS

#### 4.1 Absolute Maximum Ratings at Ta=25°C

|        | Parameter                   | Symbol    | Rating     | Unit      |
|--------|-----------------------------|-----------|------------|-----------|
| Input  | Forward Current             | $I_F$     | ±50        | mA        |
|        | Power Dissipation           | P         | 70         | mW        |
| Output | Collector - Emitter Voltage | $V_{CEO}$ | 35         | V         |
|        | Emitter - Collector Voltage | $V_{ECO}$ | 6          | V         |
|        | Collector Current           | $I_C$     | 50         | mA        |
|        | Collector Power Dissipation | $P_C$     | 150        | mW        |
|        | Total Power Dissipation     | $P_{tot}$ | 170        | mW        |
| 1.     | Isolation Voltage           | $V_{iso}$ | 3750       | $V_{rms}$ |
|        | Operating Temperature       | $T_{opr}$ | -55 ~ +110 | °C        |
|        | Storage Temperature         | $T_{stg}$ | -55 ~ +150 | °C        |
| 2.     | Soldering Temperature       | $T_{sol}$ | 260        | °C        |
|        | Junction Temperature        | $T_j$     | 125        | °C        |

1. AC For 1 Minute, R.H. = 40 ~ 60%

Isolation voltage shall be measured using the following method.

- (1) Short between anode and cathode on the primary side and between collector and emitter on the secondary side.
- (2) The isolation voltage tester with zero-cross circuit shall be used.
- (3) The waveform of applied voltage shall be a sine wave.

2. For 10 Seconds

## Photocouplers LTV354TA-V-36 series

### 4.2 ELECTRICAL OPTICAL CHARACTERISTICS at Ta=25°C

|        | Parameter                            | Symbol        | Min.               | Typ.               | Max. | Unit          | Test Condition   |
|--------|--------------------------------------|---------------|--------------------|--------------------|------|---------------|--|
| Input  | Forward Voltage                      | $V_F$         | —                  | 1.2                | 1.4  | V             | $I_F=\pm 20\text{mA}$                                  |
|        | Terminal Capacitance                 | $C_t$         | —                  | 30                 | 250  | pF            | $V=0, f=1\text{KHz}$                                   |
| Output | Collector Dark Current               | $I_{CEO}$     | —                  | —                  | 100  | nA            | $V_{CE}=20\text{V}, I_F=0$                             |
|        | Collector-Emitter Breakdown Voltage  | $BV_{CEO}$    | 35                 | —                  | —    | V             | $I_C=0.1\text{mA}, I_F=0$                              |
|        | Emitter-Collector Breakdown Voltage  | $BV_{ECO}$    | 6                  | —                  | —    | V             | $I_E=10\mu\text{A}, I_F=0$                             |
|        | Collector-Emitter Saturation Voltage | $V_{CE(sat)}$ | —                  | 0.1                | 0.2  | V             | $I_F=\pm 20\text{mA}$<br>$I_C=1\text{mA}$              |
|        | Isolation Resistance                 | $R_{iso}$     | $5 \times 10^{10}$ | $1 \times 10^{11}$ | —    | $\Omega$      | DC500V,<br>40 ~ 60% R.H.                               |
|        | Floating Capacitance                 | $C_f$         | —                  | 0.6                | 1    | pF            | $V=0, f=1\text{MHz}$                                   |
|        | Response Time (Rise)                 | $t_r$         | —                  | 4                  | 18   | $\mu\text{s}$ | $V_{CE}=2\text{V}, I_C=2\text{mA}$<br>$R_L=100\Omega,$ |
|        | Response Time (Fall)                 | $t_f$         | —                  | 3                  | 18   | $\mu\text{s}$ |  |

Photocouplers  
LTV354TA-V-36 series

5. RANK TABLE OF CURRENT TRANSFER RATIO CTR

| CTR Rank | Min | Max | Condition  |
|----------|-----|-----|--|
| A        | 50  | 150 | $I_F = \pm 1\text{mA}$ , $V_{CE} = 5\text{V}$ , $T_a = 25^\circ\text{C}$ |

$$\text{CTR} = \frac{I_C}{I_F} \times 100\%$$

# Photocouplers LTV354TA-V-36 series

## 6. CHARACTERISTICS CURVES

Fig.1 Forward Current vs. Ambient Temperature

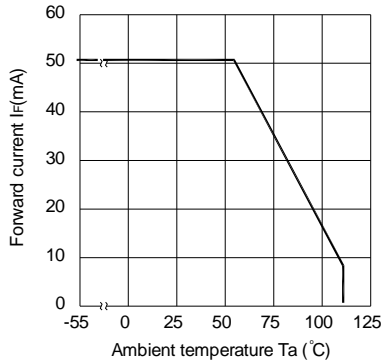

Fig.2 Collector Power Dissipation vs. Ambient Temperature

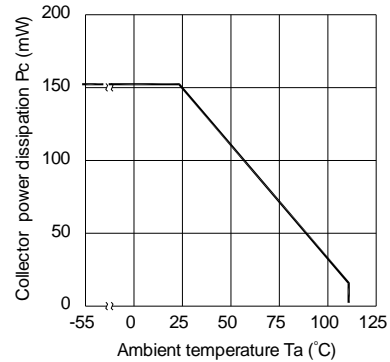

Fig.3 Collector-emitter Saturation Voltage vs. Forward Current

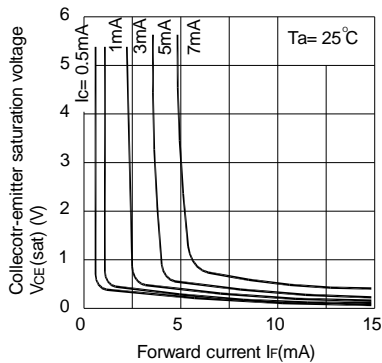

Fig.4 Forward Current vs. Forward Voltage

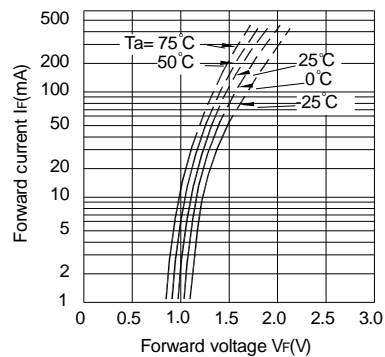

Fig.5 Current Transfer Ratio vs. Forward Current

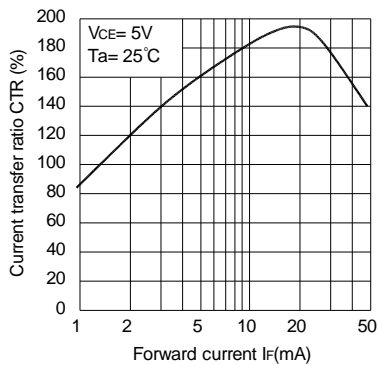
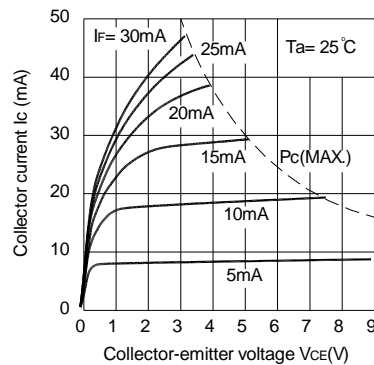

Fig.6 Collector Current vs. Collector-emitter Voltage



# Photocouplers LTV354TA-V-36 series

Fig.7 Relative Current Transfer Ratio vs. Ambient Temperature

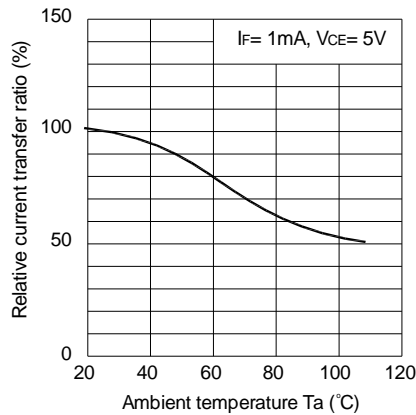

Fig.8 Collector-emitter Saturation Voltage vs. Ambient Temperature

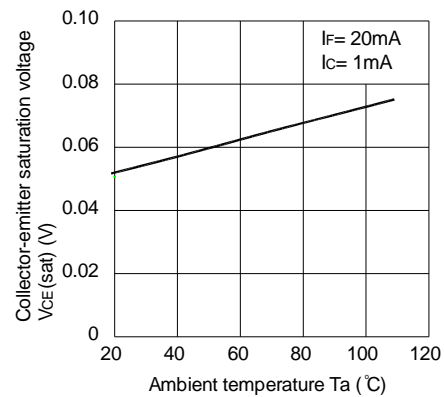

Fig.9 Collector Dark Current vs. Ambient Temperature

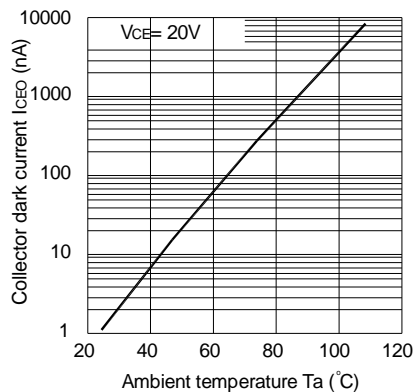

Fig.10 Response Time vs. Load Resistance

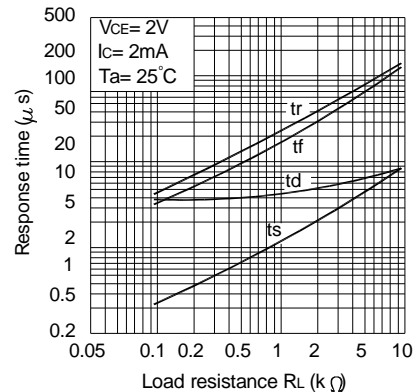
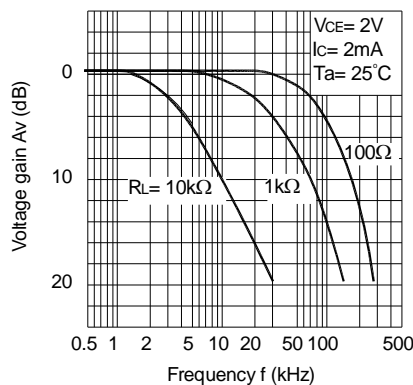
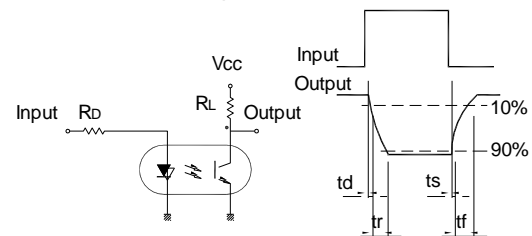

Fig.11 Frequency Response



Test Circuit for Response Time



Test Circuit for Frequency Response

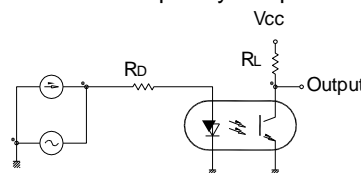

# Photocouplers LTV354TA-V-36 series

## 7. TEMPERATURE PROFILE OF SOLDERING

### 7.1 IR Reflow soldering (JEDEC-STD-020C compliant)

One time soldering reflow is recommended within the condition of temperature and time profile shown below. Do not solder more than three times.

| Profile item                     | Conditions     |
|----------------------------------|----------------|
| Preheat                          |                |
| - Temperature Min ( $T_{Smin}$ ) | 150°C          |
| - Temperature Max ( $T_{Smax}$ ) | 200°C          |
| - Time (min to max) (ts)         | 90±30 sec      |
| Soldering zone                   |                |
| - Temperature ( $T_L$ )          | 217°C          |
| - Time ( $t_L$ )                 | 60 ~ 100 sec   |
| Peak Temperature ( $T_P$ )       | 260°C          |
| Ramp-up rate                     | 3°C / sec max. |
| Ramp-down rate                   | 3~6°C / sec    |

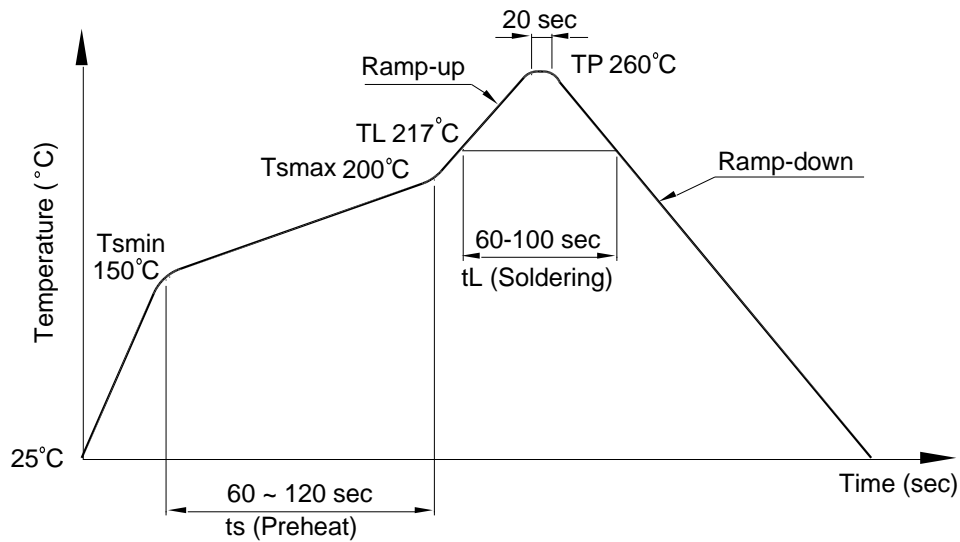

# Photocouplers LTV354TA-V-36 series

## 7.2 Wave soldering (JEDEC22A111 compliant)

One time soldering is recommended within the condition of temperature.

Temperature:  $260 \pm 0 / -5^{\circ}\text{C}$

Time: 10 sec.

Preheat temperature: 25 to  $140^{\circ}\text{C}$

Preheat time: 30 to 80 sec.

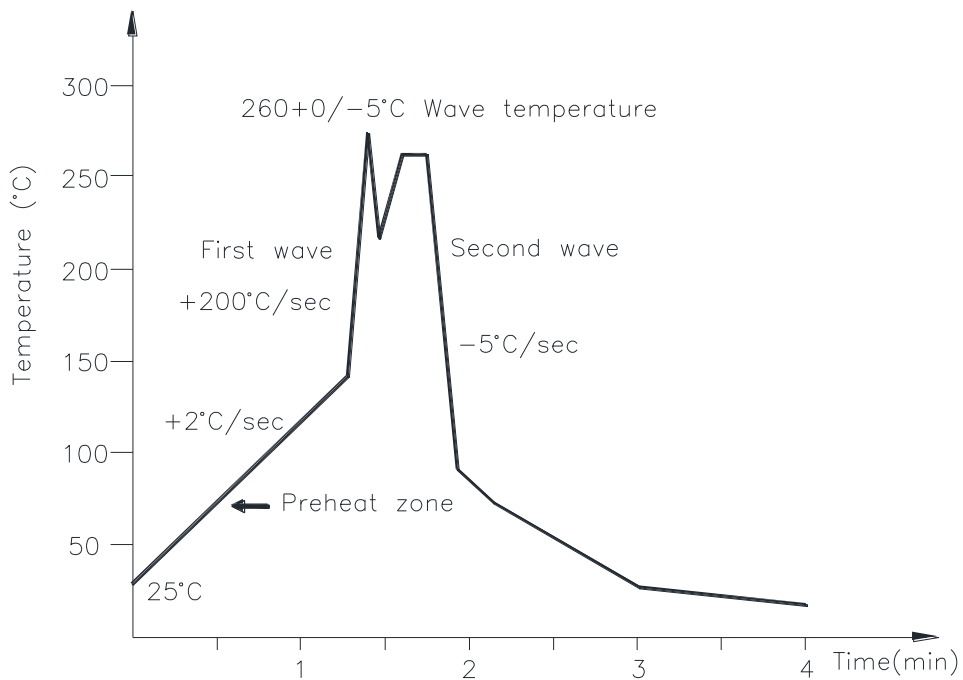

## 7.3 Hand soldering by soldering iron

Allow single lead soldering in every single process. One time soldering is recommended.

Temperature:  $380 \pm 0 / -5^{\circ}\text{C}$

Time: 3 sec max.

## Photocouplers LTV354TA-V-36 series

### 8. RRECOMMENDED FOOT PRINT PATTERNS (MOUNT PAD)

Unit: mm

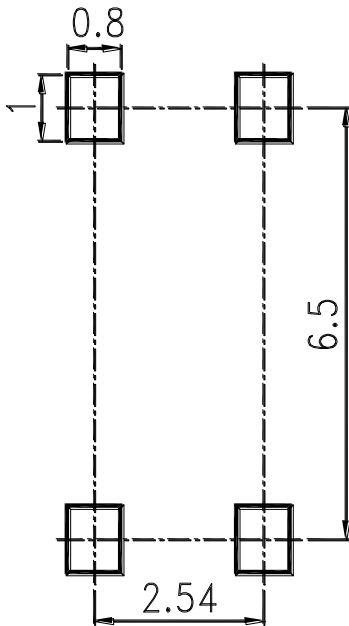

### 9. Notes:

- LiteOn is continually improving the quality, reliability, function or design and LiteOn reserves the right to make changes without further notices.
- The products shown in this publication are designed for the general use in electronic applications such as office automation equipment, communications devices, audio/visual equipment, electrical application and instrumentation.
- For equipment/devices where high reliability or safety is required, such as space applications, nuclear power control equipment, medical equipment, etc, please contact our sales representatives.
- When requiring a device for any "specific" application, please contact our sales in advice.
- If there are any questions about the contents of this publication, please contact us at your convenience.
- The contents described herein are subject to change without prior notice.
- Immerse unit's body in solder paste is not recommended.