

Distributed by:

JAMECO[®]
ELECTRONICS

www.Jameco.com ♦ 1-800-831-4242

The content and copyrights of the attached
material are the property of its owner.

Jameco Part Number 697581

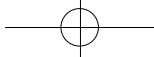

T-1(3mm) Solid State LED Lamps

- LTL-4201/4202 Red
- LTL-4211/4212 Bright Red
- LTL-4221/4222 High Efficiency Red
- LTL-4231/4232 Green
- LTL-4251/4252 Yellow
- LTL-4291/4292 Red Orange

Features

- High intensity.
- Popular T-1 Diameter package.
- Selected minimum intensities.
- Wide viewing angle.
- General purpose leads.
- Reliable and rugged.

Description

The Red source color devices are made with Gallium Arsenide Phosphide Red Light Emitting Diode.

The Bright Red source color devices are made with Gallium Phosphide on Gallium Phosphide Red Light Emitting Diode.

The High Efficiency Red and Red Orange source color devices are made with Gallium Arsenide Phosphide on Gallium Phosphide Orange Light Emitting Diode. The Green source color devices are made with Gallium Phosphide on Gallium Phosphide Green Light Emitting Diode.

The Yellow source color devices are made with Gallium Arsenide Phosphide on Gallium Phosphide Yellow Light Emitting Diode.

Package Dimensions

LTL-42x1/42x2 Series

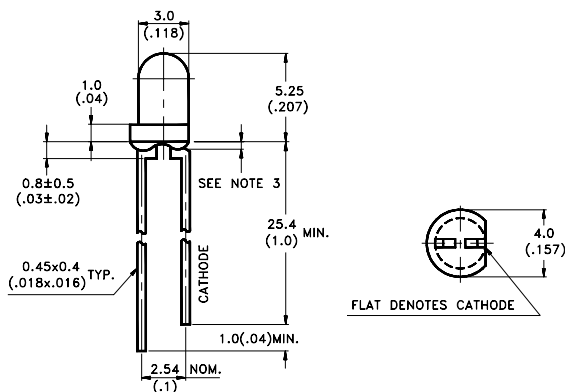

Notes:

1. All dimensions are in millimeters (inches).
2. Tolerance is ± 0.25mm (.010") unless otherwise noted.
3. Protruded resin under flange is 1.5mm (.059") max.
4. Lead spacing is measured where the leads emerge from the package.
5. Specifications are subject to change without notice.

Devices

Part No. LTL-	Lens	Source Color
4201	Red Diffused	Red
4202	Red Transparent	
4211	Red Diffused	Bright Red
4212	Red Transparent	
4221	Red Diffused	Hi. Eff. Red
4222	Red Transparent	
4231	Green Diffused	Green
4232	Green Transparent	
4251	Yellow Diffused	Yellow
4252	Yellow Transparent	
4291	Orange Diffused	Red Orange
4292	Orange Transparent	

Absolute Maximum Ratings at Ta=25°C

Parameter	Red	Bright Red	Green	Yellow	Hi. Eff. Red Red Orange	Unit
Power Dissipation	80	40	100	60	100	mW
Peak Forward Current (1/10 Duty Cycle, 0.1ms Pulse Width)	200	60	120	80	120	mA
Continuous Forward Current	40	15	30	20	30	mA
Derating Linear From 50°C	0.5	0.2	0.4	0.25	0.4	mA/°C
Reverse Voltage	5	5	5	5	5	V
Operating Temperature Range	-55°C to +100°C					
Storage Temperature Range	-55°C to +100°C					
Lead Soldering Temperature [1.6mm (.063 in.) from body]	260°C for 5 Seconds					

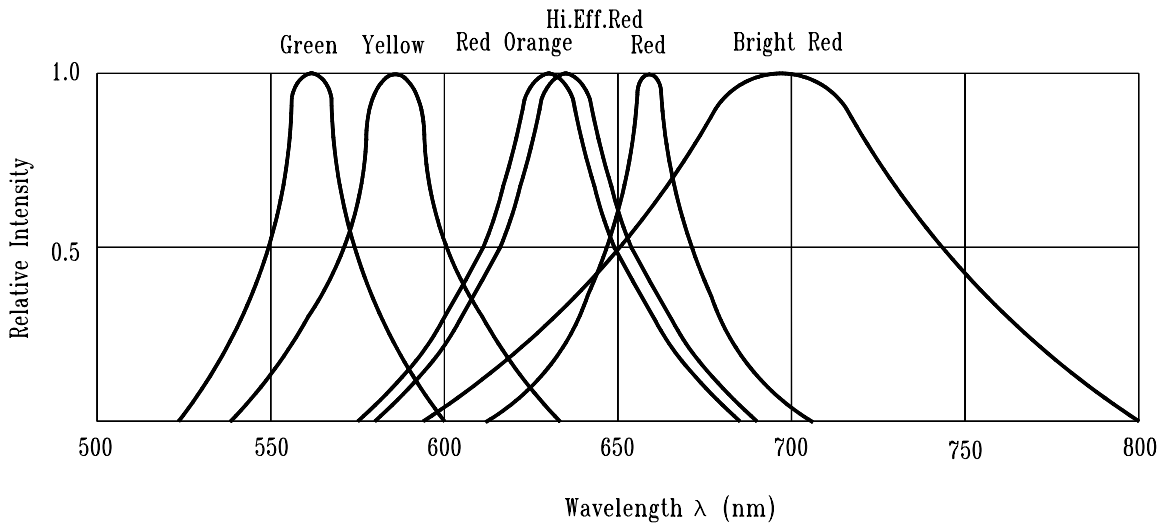

Fig.1 Relative Intensity vs. Wavelength

Electrical/Optical Characteristics at Ta=25°C

Parameter	Symbol	Part No. LTL-	Min.	Typ.	Max.	Unit.	Test Condition.
Luminous Intensity	I _v	4201	0.3	0.8		mcd	I _F =10 mA Note 1,4
		4211	0.7	2.5			
		4221	2.5	8.7			
		4231	3.7	12.6			
		4251	2.5	8.7			
		4291	3.7	12.6			
Viewing Angle	2 θ _{1/2}	42x1		40		deg	Note 2 (Fig.7)
Peak Emission Wavelength	λ _P	4201		655		nm	Measurement @Peak (Fig.1)
		4211		697			
		4221		635			
		4231		565			
		4251		585			
		4291		630			
Dominant Wavelength	λ _d	4201		651		nm	Note 3
		4211		657			
		4221		623			
		4231		569			
		4251		588			
		4291		621			
Spectral Line Half Width	Δλ	4201		24		nm	
		4211		90			
		4221		40			
		4231		30			
		4251		35			
		4291		40			
Forward Voltage	V _F	4201		1.7	2.0	V	I _F =20mA
		4211		2.1	2.6		
		4221		2.0	2.6		
		4231		2.1	2.6		
		4251		2.1	2.6		
		4291		2.0	2.6		
Reverse Current	I _R	42x1			100	μA	V _R =5V
Capacitance	C	4201		30		pF	V _F =0 , f=1MHz
		4211		55			
		4221		20			
		4231		35			
		4251		15			
		4291		20			

Notes:1.Luminous intensity is measured with a light sensor and filter combination that approximates the CIE eye-response curve.

2. θ_{1/2} is the off-axis angle at which the luminous intensity is half the axial luminous intensity.

3.The dominant wavelength, λ_d is derived from the CIE chromaticity diagram and represents the single wavelength which defines the color of the device.

4.I_v needs ± 15% additionaly for guaranteed limits.

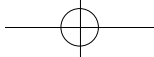

Electrical/Optical Characteristics at Ta=25°C

Parameter	Symbol	Part No. LTL-	Min.	Typ.	Max.	Unit.	Test Condition.
Luminous Intensity	I _v	4202	1.7	5.6		mcd	I _F =10 mA Note 1,4
		4212	2.5	8.7			
		4222	8.7	29			
		4232	12.6	40			
		4252	5.6	19			
		4292	8.7	29			
Viewing Angle	2 θ _{1/2}	42x2		20		deg	Note 2 (Fig.15)
Peak Emission Wavelength	λ _P	4202		655		nm	Measurement @ Peak (Fig.1)
		4212		697			
		4222		635			
		4232		565			
		4252		585			
		4292		630			
Dominant Wavelength	λ _d	4202		651		nm	Note 3
		4212		657			
		4222		623			
		4232		569			
		4252		588			
		4292		621			
Spectral Line Half Width	Δλ	4202		24		nm	
		4212		90			
		4222		40			
		4232		30			
		4252		35			
		4292		40			
Forward Voltage	V _F	4202		1.7	2.0	V	I _F =20mA
		4212		2.1	2.6		
		4222		2.0	2.6		
		4232		2.1	2.6		
		4252		2.1	2.6		
		4292		2.0	2.6		
Reverse Current	I _R	42x2			100	μA	V _R =5V
Capacitance	C	4202		30		pF	V _F =0, f=1MHz
		4212		55			
		4222		20			
		4232		35			
		4252		15			
		4292		20			

Notes:1.Luminous intensity is measured with a light sensor and filter combination that approximates the CIE eye-response curve.

2. θ_{1/2} is the off-axis angle at which the luminous intensity is half the axial luminous intensity.

3.The dominant wavelength, λ_d is derived from the CIE chromaticity diagram and represents the single wavelength which defines the color of the device.

4.I_v needs ± 15% additionaly for guaranteed limits.

THROUGH HOLE LAMPS

Typical Electrical/Optical Characteristic Curves (25°C Ambient Temperature Unless Otherwise Noted)

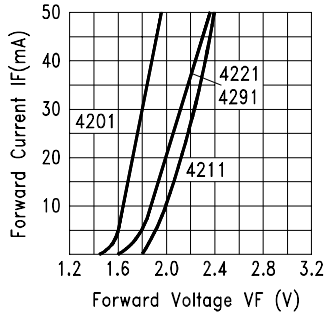

Fig.2 FORWARD CURRENT VS. FORWARD VOLTAGE

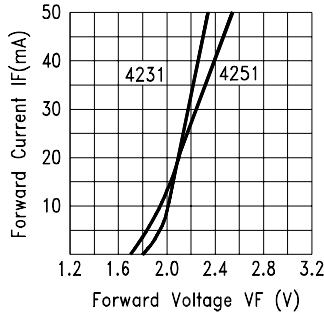

Fig.3 FORWARD CURRENT VS. FORWARD VOLTAGE

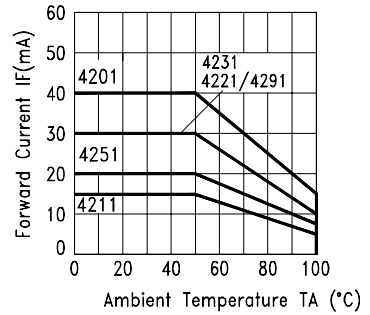

Fig.4 FORWARD CURRENT DERATING CURVE

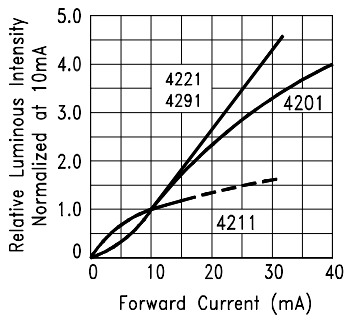

Fig.5 RELATIVE LUMINOUS INTENSITY VS. FORWARD CURRENT

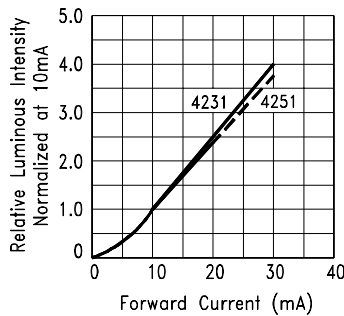

Fig.6 RELATIVE LUMINOUS INTENSITY VS. FORWARD CURRENT

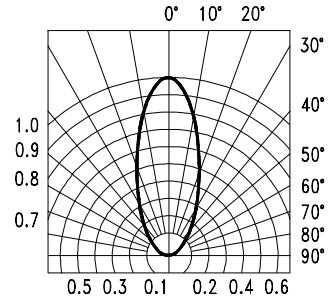

Fig.7 SPATIAL DISTRIBUTION

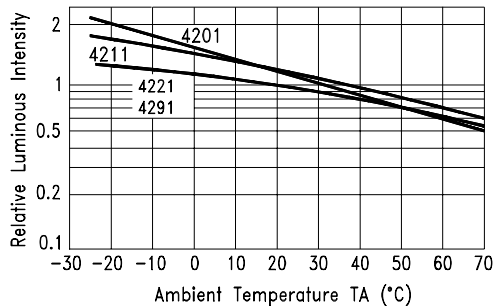

Fig.8 LUMINOUS INTENSITY VS. AMBIENT TEMPERATURE

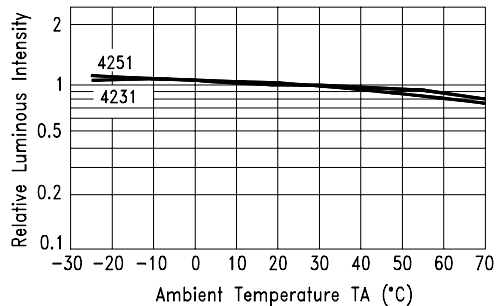
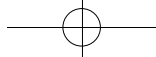

Fig.9 LUMINOUS INTENSITY VS. AMBIENT TEMPERATURE



Typical Electrical/Optical Characteristic Curves (25°C Ambient Temperature Unless Otherwise Noted)

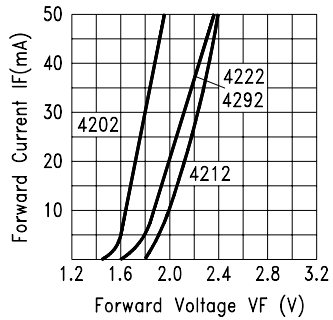

Fig.10 FORWARD CURRENT VS. FORWARD VOLTAGE

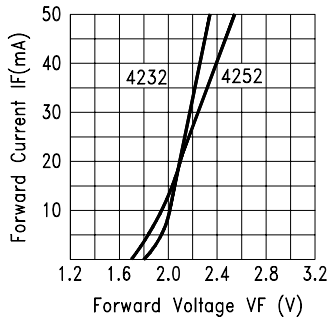

Fig.11 FORWARD CURRENT VS. FORWARD VOLTAGE

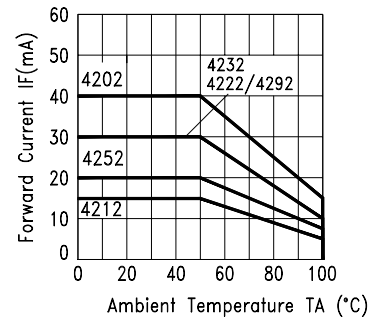

Fig.12 FORWARD CURRENT DERATING CURVE

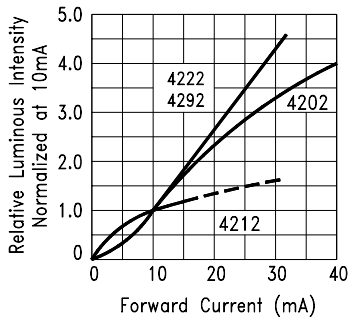

Fig.13 RELATIVE LUMINOUS INTENSITY VS. FORWARD CURRENT

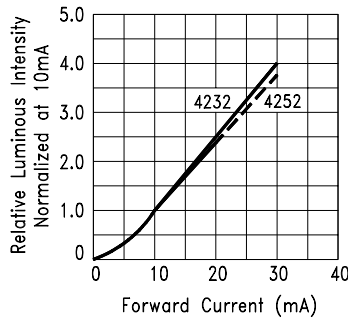

Fig.14 RELATIVE LUMINOUS INTENSITY VS. FORWARD CURRENT

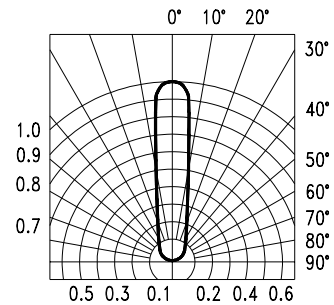

Fig.15 SPATIAL DISTRIBUTION

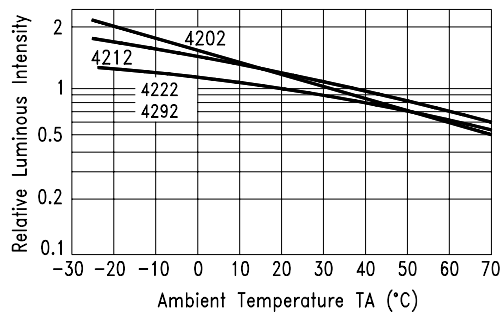

Fig.16 LUMINOUS INTENSITY VS. AMBIENT TEMPERATURE

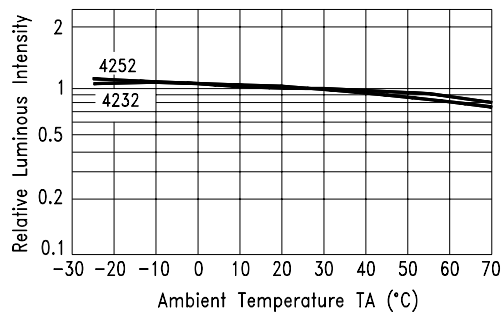

Fig.17 LUMINOUS INTENSITY VS. AMBIENT TEMPERATURE

THROUGH HOLE LAMPS