

LQH55DN220M03#

“#” at the end indicates the package specification code.

Large Current



< List of part numbers with package codes >

LQH55DN220M03K LQH55DN220M03L

Applications

Unsuitable Applications	Please be sure to read and comply with these "Precautions for use."
Specific Applications	Consumer equipment, Medical equipment [GHTF A/B/C] except for implant & surgery & auto injector, Industrial equipment except for transportation & facility & energy equipment Please refer to Our Website and specifications, etc. for information about the performance, functions, quality, management, and safety required for the above applications, and use Products after confirming the performance and reliability of the actual Product.
Recommended Applications	Consumer equipment

Appearance & Shape

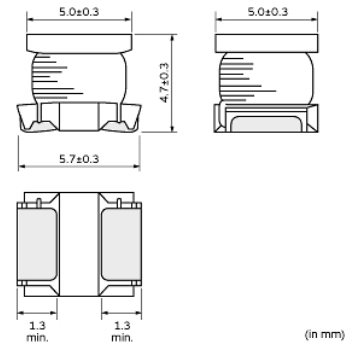
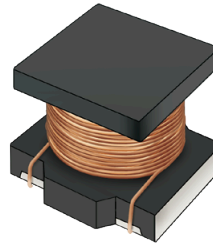

Notices

When rated current is applied to the products, inductance will be within $\pm 40\%$ of initial inductance value. When rated current is applied to the products, the temperature rise caused by self-generated heat shall be limited to 40°C max.

Attention

- 1.This datasheet is downloaded from the website of Murata Manufacturing Co., Ltd. Therefore, it's specifications are subject to change or our products in it may be discontinued without advance notice. Please check with our sales representatives or product engineers before ordering.
- 2.This datasheet has only typical specifications because there is no space for detailed specifications.
Therefore, please review our product specifications or consult the approval sheet for product specifications before ordering.

LQH55DN220M03#

“#” at the end indicates the package specification code.

References

Packaging	Specifications	Standard Packing Quantity
K	330Embossed Tape	1500
L	180Embossed Tape	350

Mass (typ.)	
1 piece	0.48g

Attention

1.This datasheet is downloaded from the website of Murata Manufacturing Co., Ltd. Therefore, it's specifications are subject to change or our products in it may be discontinued without advance notice. Please check with our sales representatives or product engineers before ordering.

2.This datasheet has only typical specifications because there is no space for detailed specifications.

Therefore, please review our product specifications or consult the approval sheet for product specifications before ordering.

LQH55DN220M03#

“#” at the end indicates the package specification code.



Specifications

L size	5.7±0.3mm
W size	5.0±0.3mm
T size	4.7±0.3mm
Size code inch (mm)	2220 (5750)
Inductance	22μH±20%
Inductance Test Frequency	1MHz
Rated current (Itemp) (Based on Temperature rise)	1.2A
Max. of DC resistance	0.266Ω
DC resistance	0.19Ω±40%
Operating Temperature Range(Self-temperature rise is not included)	-40°C to 80°C
Class of magnetic shield	Non-Shielded
Self resonance frequency (min.)	15MHz
Brand	Murata
Series	LQH55DN_03

Attention

1.This datasheet is downloaded from the website of Murata Manufacturing Co., Ltd. Therefore, it's specifications are subject to change or our products in it may be discontinued without advance notice. Please check with our sales representatives or product engineers before ordering.

2.This datasheet has only typical specifications because there is no space for detailed specifications.

Therefore, please review our product specifications or consult the approval sheet for product specifications before ordering.

LQH55DN220M03#

“#” at the end indicates the package specification code.



Characteristic Data

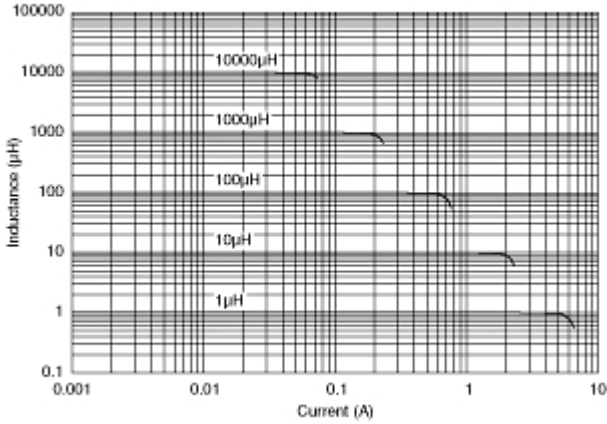

Impedance - Current Characteristics

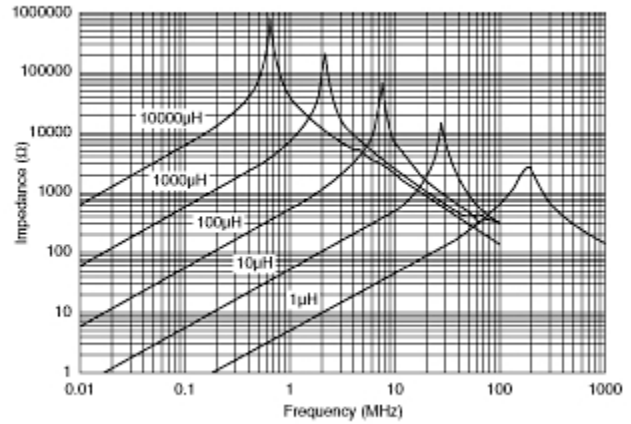

Impedance - Frequency Characteristics

Attention

1. This datasheet is downloaded from the website of Murata Manufacturing Co., Ltd. Therefore, its specifications are subject to change or our products in it may be discontinued without advance notice. Please check with our sales representatives or product engineers before ordering.
2. This datasheet has only typical specifications because there is no space for detailed specifications.
Therefore, please review our product specifications or consult the approval sheet for product specifications before ordering.