

LQH3NPN100MME#

“#” indicates a package specification code.

Size Code 3030 (1212) in mm (in inch), 1.5mm max.Thickness. high performance type.



< List of part numbers with package codes >

LQH3NPN100MMEB LQH3NPN100MMEL LQH3NPN100MMEK

Appearance & Shape

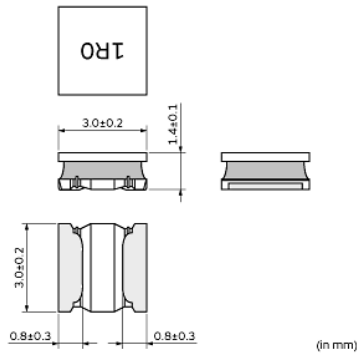
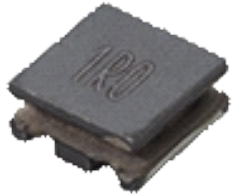

Notices

When rated current is applied to the products, inductance will be within ±30% of initial inductance value range. Keep the temperature (ambient temperature plus self-generation of heat) under 125°C. When rated current is applied to the products, the self-temperature rise shall be limited to 40°C max. (ambient temperature 85°C). When rated current is applied to the products, the self-temperature rise shall be limited to 20°C max. (ambient temperature 85°C to 105°C).

Attention

- 1.This datasheet is downloaded from the website of Murata Manufacturing Co., Ltd. Therefore, it's specifications are subject to change or our products in it may be discontinued without advance notice. Please check with our sales representatives or product engineers before ordering.
 - 2.This datasheet has only typical specifications because there is no space for detailed specifications.
- Therefore, please review our product specifications or consult the approval sheet for product specifications before ordering.

LQH3NPN100MME#

“#” indicates a package specification code.

References

Packaging	Specifications	Minimum Order Quantity
B	Bulk(Bag)	100
L	180Embossed Tape	2000
K	330Embossed Tape	8000

Mass (typ.)	
1 piece	0.051g

Attention

- 1.This datasheet is downloaded from the website of Murata Manufacturing Co., Ltd. Therefore, it's specifications are subject to change or our products in it may be discontinued without advance notice. Please check with our sales representatives or product engineers before ordering.
 - 2.This datasheet has only typical specifications because there is no space for detailed specifications.
- Therefore, please review our product specifications or consult the approval sheet for product specifications before ordering.

LQH3NPN100MME#

“#” indicates a package specification code.

Specifications

L size	3.0±0.2mm
W size	3.0±0.2mm
T size	1.4±0.1mm
Size code inch (mm)	1212 (3030)
Inductance	10μH±20%
Inductance Test Frequency	1MHz
Rated current (I _{sat}) (Based on Inductance change)	810mA
Rated current (I _{temp}) (Based on Temperature rise)	1280mA(Ambient temp.85°C)800mA(Ambient temp.105°C)
Max. of DC resistance	0.228Ω
Operating Temperature Range (Self-temperature rise is included)	-40°C to 125°C
Class of magnetic shield	Magnetic Resin
Self resonance frequency (min.)	20MHz
Operating Temperature Range(Self-temperature rise is not included)	-40°C to 105°C
DC Resistance Intermediate Values	0.19Ω±20%
Series	LQH3NPN_ME

Attention

1.This datasheet is downloaded from the website of Murata Manufacturing Co., Ltd. Therefore, it's specifications are subject to change or our products in it may be discontinued without advance notice. Please check with our sales representatives or product engineers before ordering.

2.This datasheet has only typical specifications because there is no space for detailed specifications.

Therefore, please review our product specifications or consult the approval sheet for product specifications before ordering.

LQH3NPN100MME#

“#” indicates a package specification code.

Characteristic Data

The charts below may show another part number which shares its characteristics.

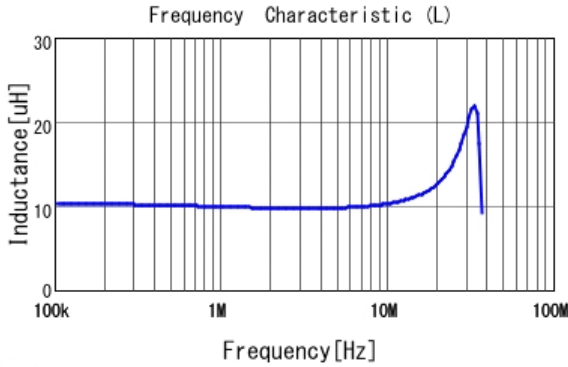

■ LQH3NPN100MME L

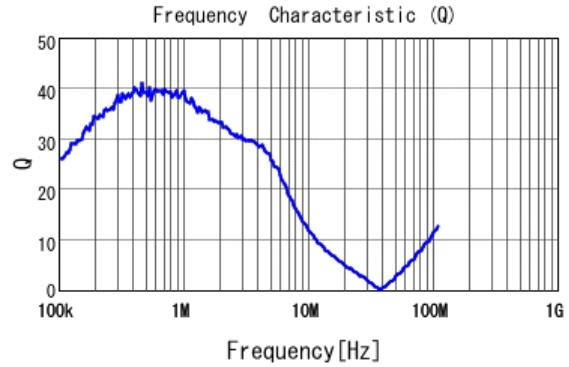

■ LQH3NPN100MME Q

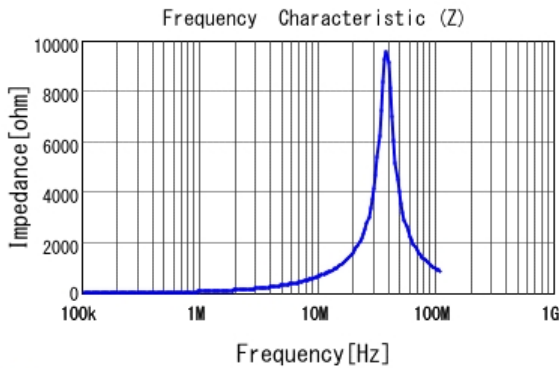

■ LQH3NPN100MME |Z|

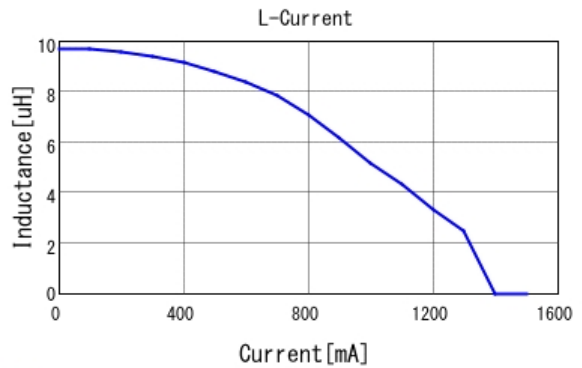

■ LQH3NPN100MME L-Current 20degC

Attention

1.This datasheet is downloaded from the website of Murata Manufacturing Co., Ltd. Therefore, it's specifications are subject to change or our products in it may be discontinued without advance notice. Please check with our sales representatives or product engineers before ordering.

2.This datasheet has only typical specifications because there is no space for detailed specifications.

Therefore, please review our product specifications or consult the approval sheet for product specifications before ordering.

LQH3NPN100MME#

“#” indicates a package specification code.

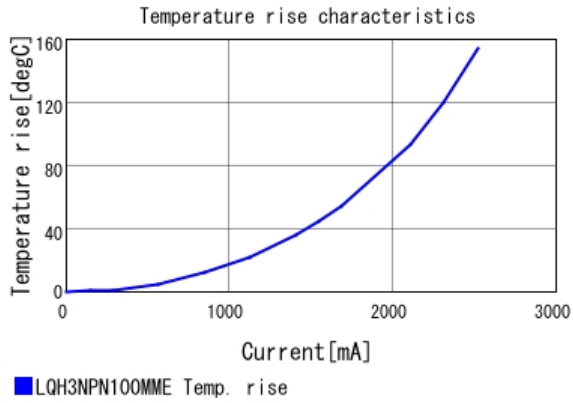

Attention

- 1.This datasheet is downloaded from the website of Murata Manufacturing Co., Ltd. Therefore, it's specifications are subject to change or our products in it may be discontinued without advance notice. Please check with our sales representatives or product engineers before ordering.
 - 2.This datasheet has only typical specifications because there is no space for detailed specifications.
- Therefore, please review our product specifications or consult the approval sheet for product specifications before ordering.