

# LQH2HPZ1R2NJR#

"#" indicates a package specification code.

Size Code 2520 (1008) in mm (in inch), 1.2mm max. Thickness. Low DC resistance design



< List of part numbers with package codes >  
LQH2HPZ1R2NJRL

## Appearance & Shape

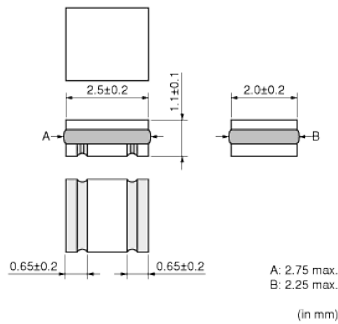
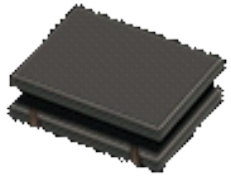

## Notices

When rated current is applied to the products, inductance will be within  $\pm 30\%$  of initial inductance value range. Keep the temperature (ambient temperature plus self-generation of heat) under  $125^{\circ}\text{C}$ . When rated current is applied to the products, the self-temperature rise shall be limited to  $40^{\circ}\text{C}$  max. (ambient temperature  $85^{\circ}\text{C}$ ). When rated current is applied to the products, the self-temperature rise shall be limited to  $20^{\circ}\text{C}$  max. (ambient temperature  $85^{\circ}\text{C}$  to  $105^{\circ}\text{C}$ ).

### Attention

- 1.This datasheet is downloaded from the website of Murata Manufacturing Co., Ltd. Therefore, it's specifications are subject to change or our products in it may be discontinued without advance notice. Please check with our sales representatives or product engineers before ordering.
  - 2.This datasheet has only typical specifications because there is no space for detailed specifications.
- Therefore, please review our product specifications or consult the approval sheet for product specifications before ordering.

# LQH2HPZ1R2NJR#

"#" indicates a package specification code.

## References

Packaging	Specifications	Minimum Order Quantity
L	180Embossed Tape	2000

Mass (typ.)	
1 piece	0.023g

### Attention

1.This datasheet is downloaded from the website of Murata Manufacturing Co., Ltd. Therefore, it's specifications are subject to change or our products in it may be discontinued without advance notice. Please check with our sales representatives or product engineers before ordering.

2.This datasheet has only typical specifications because there is no space for detailed specifications.

Therefore, please review our product specifications or consult the approval sheet for product specifications before ordering.

# LQH2HPZ1R2NJR#

"#" indicates a package specification code.

## Specifications

L size	2.5±0.2mm
W size	2.0±0.2mm
T size	1.1±0.1mm
Size code inch (mm)	1008 (2520)
Inductance	1.2μH±30%
Inductance Test Frequency	1MHz
Rated current (I <sub>sat</sub> ) (Based on Inductance change)	2450mA
Rated current (I <sub>temp</sub> ) (Based on Temperature rise)	2070mA(Ambient temp.85°C)1240mA(Ambient temp.105°C)
Max. of DC resistance	0.066Ω
Operating Temperature Range (Self-temperature rise is included)	-40°C to 125°C
Class of magnetic shield	Magnetic Resin
Self resonance frequency (min.)	100MHz
Operating Temperature Range(Self-temperature rise is not included)	-40°C to 105°C
DC Resistance Intermediate Values	0.055Ω±20%
Series	LQH2HPZ_JR

### Attention

1.This datasheet is downloaded from the website of Murata Manufacturing Co., Ltd. Therefore, it's specifications are subject to change or our products in it may be discontinued without advance notice. Please check with our sales representatives or product engineers before ordering.

2.This datasheet has only typical specifications because there is no space for detailed specifications.

Therefore, please review our product specifications or consult the approval sheet for product specifications before ordering.

# LQH2HPZ1R2NJR#

"#" indicates a package specification code.

## Characteristic Data

The charts below may show another part number which shares its characteristics.

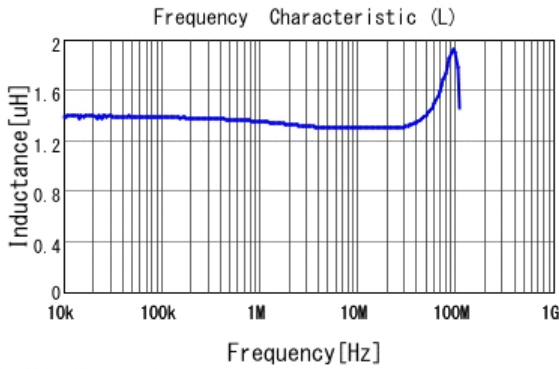

■ LQH2HPZ1R2NJR L

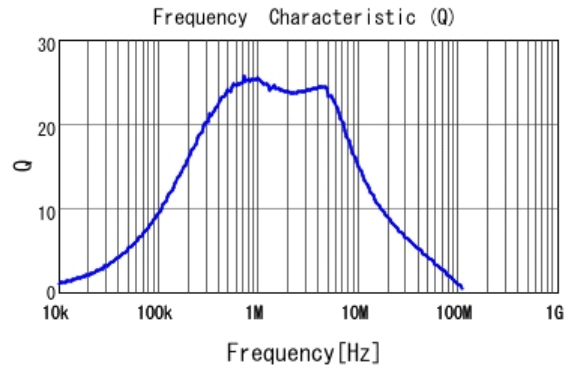

■ LQH2HPZ1R2NJR Q

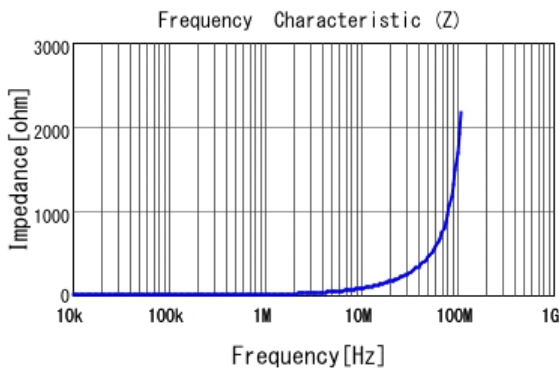

■ LQH2HPZ1R2NJR |Z|

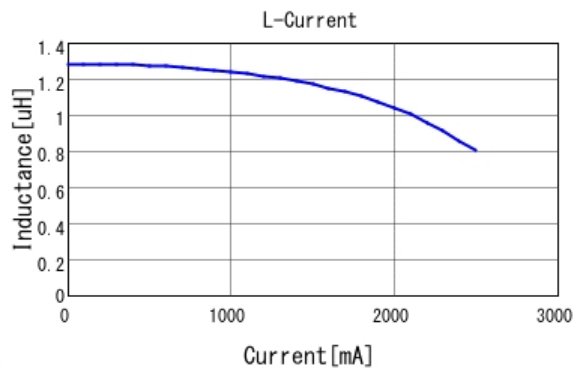

■ LQH2HPZ1R2NJR L-Current 20degC

**Attention**

- 1.This datasheet is downloaded from the website of Murata Manufacturing Co., Ltd. Therefore, it's specifications are subject to change or our products in it may be discontinued without advance notice. Please check with our sales representatives or product engineers before ordering.
- 2.This datasheet has only typical specifications because there is no space for detailed specifications.  
Therefore, please review our product specifications or consult the approval sheet for product specifications before ordering.

# LQH2HPZ1R2NJR#

"#" indicates a package specification code.

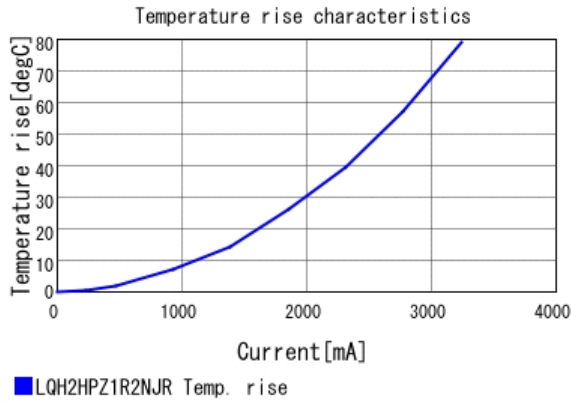

**Attention**

- 1.This datasheet is downloaded from the website of Murata Manufacturing Co., Ltd. Therefore, it's specifications are subject to change or our products in it may be discontinued without advance notice. Please check with our sales representatives or product engineers before ordering.
  - 2.This datasheet has only typical specifications because there is no space for detailed specifications.
- Therefore, please review our product specifications or consult the approval sheet for product specifications before ordering.