

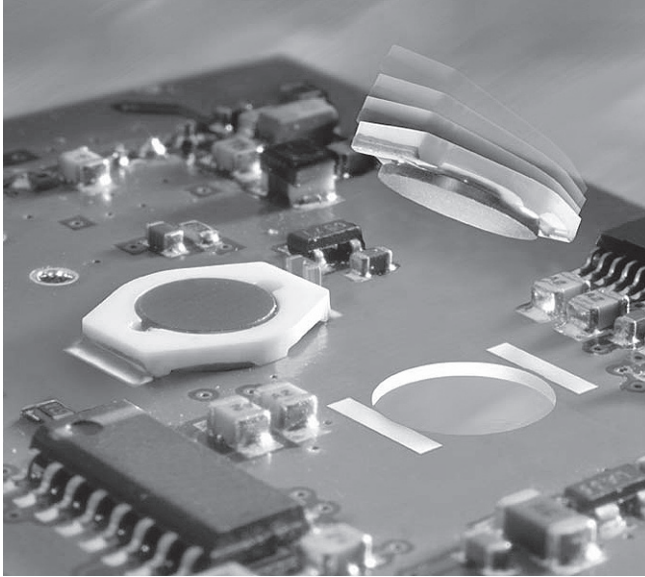

# SMT Power Inductors - LPO2506



- On-board style – 1.65 mm high
- InBoard® style – only 1.19 mm high

**Designer's Kit C332** contains 3 of all InBoard® styles  
**Designer's Kit C333** contains 3 of all On-board styles

**Core material** Ferrite

**Core and winding loss** See [www.coilcraft.com/coreloss](http://www.coilcraft.com/coreloss)

**Terminations** RoHS compliant silver-palladium-platinum-glass frit.  
 Other terminations available at additional cost.

**Weight** 240 – 260 mg

**Ambient temperature** –40°C to +85°C with Irms current, +85°C to +125°C with derated current

**Storage temperature** Component: –40°C to +125°C.  
 Tape and reel packaging: –40°C to +80°C

**Resistance to soldering heat** Max three 40 second reflows at +260°C, parts cooled to room temperature between cycles

**Moisture Sensitivity Level (MSL)** 1 (unlimited floor life at <30°C / 85% relative humidity)

**Failures in Time (FIT) / Mean Time Between Failures (MTBF)**  
 38 per billion hours / 26,315,789 hours, calculated per Telcordia SR-332

**Packaging** 1000/13" reel Plastic tape: 12 mm wide, 0.23 mm thick, 8 mm pocket spacing, 1.37 mm pocket depth

**PCB washing** Only pure water or alcohol recommended

InBoard style part number <sup>1</sup>	On-board style part number <sup>1</sup>	L ±20% <sup>2</sup> (µH)	DCR max (Ohms)	SRF typ (MHz)	Isat <sup>3</sup> (A)	Irms <sup>4</sup> (A)
LPO2506I-472L_	LPO2506O-472L_	4.7	0.145	90	1.6	1.9
LPO2506I-682L_	LPO2506O-682L_	6.8	0.165	75	1.3	1.7
LPO2506I-822L_	LPO2506O-822L_	8.2	0.200	65	1.0	1.5
LPO2506I-103L_	LPO2506O-103L_	10	0.240	60	1.0	1.5
LPO2506I-153L_	LPO2506O-153L_	15	0.300	45	0.90	1.3
LPO2506I-223L_	LPO2506O-223L_	22	0.420	35	0.70	1.0
LPO2506I-333L_	LPO2506O-333L_	33	0.550	30	0.60	0.90
LPO2506I-473L_	LPO2506O-473L_	47	0.765	22	0.50	0.70
LPO2506I-683L_	LPO2506O-683L_	68	1.10	20	0.40	0.60
LPO2506I-104L_	LPO2506O-104L_	100	1.60	15	0.30	0.50
LPO2506I-154L_	LPO2506O-154L_	150	2.50	12	0.25	0.40
LPO2506I-224L_	LPO2506O-224L_	220	3.65	10	0.22	0.32
LPO2506I-334L_	LPO2506O-334L_	330	4.65	8.0	0.18	0.28
LPO2506I-474L_	LPO2506O-474L_	470	6.75	6.5	0.14	0.24
LPO2506I-684L_	LPO2506O-684L_	680	9.15	5.5	0.12	0.20
LPO2506I-105L_	LPO2506O-105L_	1000	14.20	4.5	0.10	0.16

1. When ordering, please specify **termination** and **packaging** codes:

**LPO2506O-105LD**

**Termination:** L = RoHS compliant silver-palladium-platinum-glass frit  
**Special order:** T = RoHS tin-silver-copper (95.5/4/0.5) or S = non-RoHS tin-lead (63/37).

**Packaging:** D = 13" machine-ready reel. EIA-481 embossed plastic tape (1000 parts per full reel).

B = Less than full reel. In tape, but not machine ready.  
 To have a leader and trailer added (\$25 charge), use code letter D instead.

2. Inductance tested at 100 kHz, 0.1 Vrms, 0 Adc using an Agilent/HP 4263B LCR meter or equivalent.

3. DC current at which the inductance drops 10% (typ) from its value without current.

4. Current that causes a 40°C temperature rise from 25°C ambient.

5. Electrical specifications at 25°C.

Refer to Doc 362 "Soldering Surface Mount Components" before soldering.

**SPICE models** ON OUR WEB SITE

Document 208-1 Revised 03/07/11

© Coilcraft Inc. 2011

This product may not be used in medical or high risk applications without prior Coilcraft approval. Specifications subject to change without notice. Please check our web site for latest information.

**Coilcraft**

[www.coilcraft.com](http://www.coilcraft.com)

**US** +1-847-639-6400 [sales@coilcraft.com](mailto:sales@coilcraft.com)

**UK** +44-1236-730595 [sales@coilcraft-europe.com](mailto:sales@coilcraft-europe.com)

**Taiwan** +886-2-2264 3646 [sales@coilcraft.com.tw](mailto:sales@coilcraft.com.tw)

**China** +86-21-6218 8074 [sales@coilcraft.com.cn](mailto:sales@coilcraft.com.cn)

**Singapore** + 65-6484 8412 [sales@coilcraft.com.sg](mailto:sales@coilcraft.com.sg)



# SMT Power Inductors - LPO2506 Series

## Typical L vs Frequency

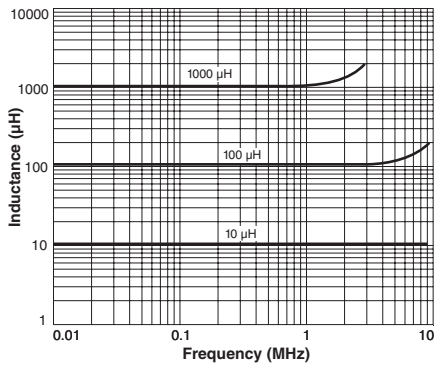

## Typical L vs Current

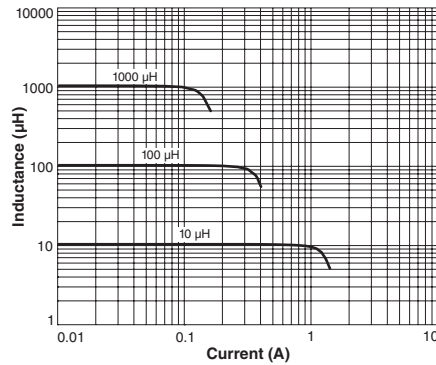

## Current Derating

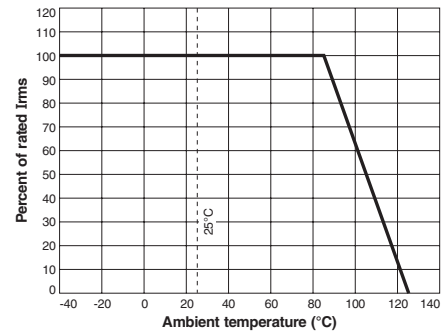

## On-board Style

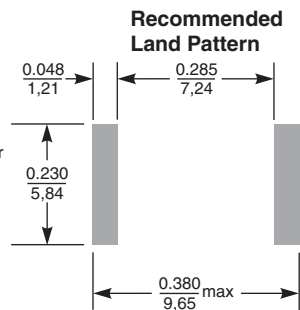
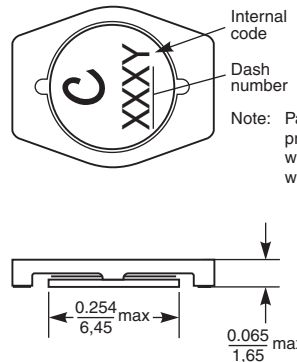
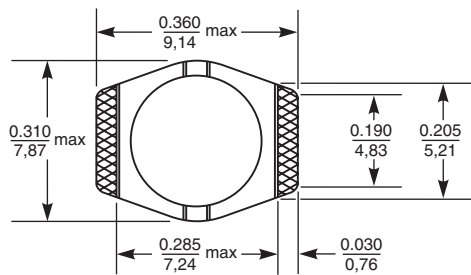

## InBoard Style

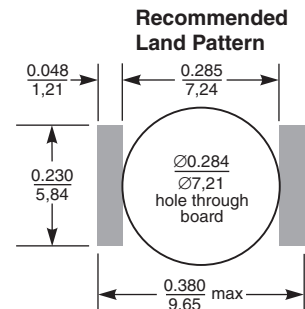
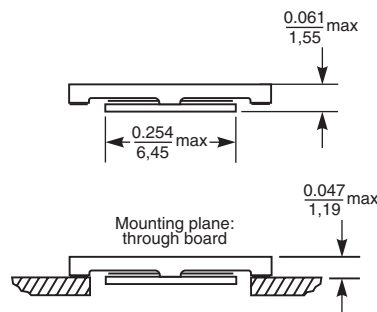
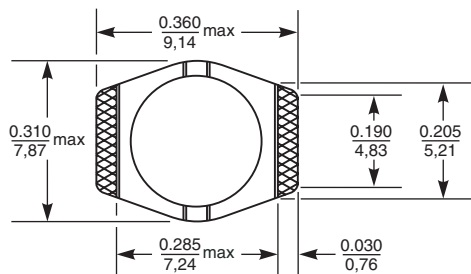

**US** +1-847-639-6400 sales@coilcraft.com  
**UK** +44-1236-730595 sales@coilcraft-europe.com  
**Taiwan** +886-2-2264 3646 sales@coilcraft.com.tw  
**China** +86-21-6218 8074 sales@coilcraft.com.cn  
**Singapore** + 65-6484 8412 sales@coilcraft.com.sg

Document 208-2 Revised 03/07/11  
 © Coilcraft Inc. 2011  
 This product may not be used in medical or high risk applications without prior Coilcraft approval. Specifications subject to change without notice. Please check our web site for latest information.