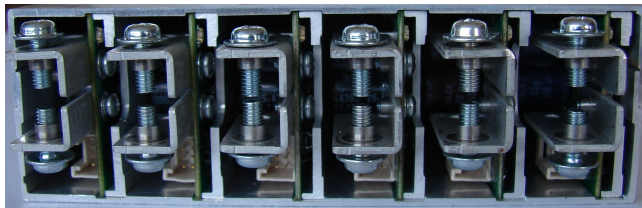




## APPLICATIONS

- Industrial equipment
- Telecommunications
- Test and measurement
- Automation
- Peripherals
- Audio/broadcast
- Linear and rotary motion



Rear Module Connection Area



Supply Front View

## FEATURES

- Wide input voltage range from DC to 440Hz AC
- Standard output voltages of 2.2 to 51 VDC
- Efficiencies up to 86% typical
- Extra-Low 1U profile: 1.6 inch
- High power density design of 18 Watts/cubic inch
- 1 to 6 isolated outputs with full user configurability
- Power Factor Correction (PFC) IEC 61000-3-2 compliant
- 1300W @ 115 VAC or 1600W @ 230VAC of total output power
- Zero-load operation
- Single-wire current sharing
- Universal input AC range
- Individual control signals on each module
- Auxiliary power 5V (1A)

**Figure 1. LPM616 Expanded Views**

### 1. Description

The LPM616 Series is a modular 1600-watt AC-DC power supply that provides a market-leading power density of 18 watts per cubic inch and has an extra low 1U profile. The LPM616 offers the flexibility of a modular architecture and the combination of high efficiency and high power density.

Designed for use where a unique set of voltage and current requirements are needed, the supply's six slots can be configured with PCB-based output modules to deliver up to six outputs. The LPM output modules operate in any chassis position and can provide up to 1600 watts total power from a 150 VAC input and 1300 watts from a 100 VAC input. Forced-air cooling with airflow direction from front to back is provided by internal fans.

For LPM616 supplies using less than the six-slot capability, blanking plates are installed for safety purposes and to optimize airflow within the chassis. The supplies are pre-set with default output module settings or with the customer's desired output settings prior to delivery. The LPM616 chassis can be populated with the output modules listed in *Table 1*.

**Table 1. Module Selection**

| MODULE | NO. OF SLOTS REQUIRED | FACTORY-SET SINGLE-OUTPUT (VDC) | MODULE ADJUSTABLE RANGE (VDC) | MAX. OUTPUT CURRENT (AMPS) | MAX. OUTPUT POWER<br>Note 2<br>(WATTS) |
|--------|-----------------------|---------------------------------|-------------------------------|----------------------------|--|
| A      | 1                     | 5                               | 2.2 to 5.2                    | 53                         | 266                                    |
| B      | 1                     | 12                              | 5.2 to 15                     | 22                         | 266                                    |
| C      | 1                     | 24                              | 15 to 32                      | 11                         | 266                                    |
| D      | 1                     | 48                              | 32 to 51                      | 5.5                        | 266                                    |
| 0      | 1                     | Blank Panel Slot Cover          |                               |                            |  |

**NOTE 1:** To determine your desired power supply's part number, please refer to *Figure 2* for a detailed part number description. Use the **LPM616 Product Configurator** located in the Modular Section on our website, or use our contacts page to locate a contact or distributor for further assistance.

**NOTE 2:** Values given for high line, from 150 VAC. By low line is the module output power derated to 183 W ( $V_{in}=85-100VAC$ ), resp. 217 W ( $V_{in}=100-150VAC$ ).

#### 1.1 Output Voltage and Current Limit Adjustments

Each LPM616 module's output voltage and current limit is adjustable by means of a trimmer located on the module and accessible through the adjustment holes located on the bottom of the power supply (see *Figure 10*). We dissuade to change current limits, which are factory preset.

#### 1.2 Parallel Connections

Depending on certain situations where current requirements exceed one module's capability, the configurator will process a solution using parallel connections. Paralleling busbars are available to make the connections requiring higher current needs. For proper current sharing function it is necessary to interconnect Current Share pins of all modules by signal wires. For more details read the *Output Signal Connector* and *Accessories* section.

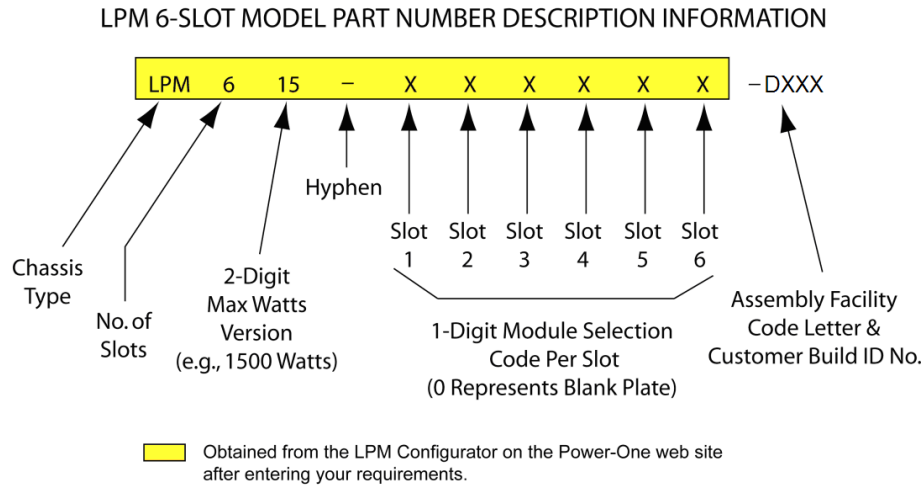
## 2. Part Numbering and Ordering Information

### 2.1 Chassis Identification Numbering

First left-to-right sequence of the part number (4 characters):

- LPM616 .....Low Profile Modular 6-slot, 1600W, with single-phase AC input. (see Figure 2)

Note: Chassis and modules are RoHS-6 compliant.



**Figure 2. LPM 6-Slot Part Number Structure**

**Example:** After entering your requirements, the web Configurator optimized part number recommended could be: LPM616-000DAC-DXXX which represents: Low Profile Modular Series with single-phase AC input, 6-slot, 1600W chassis with modules of: 3x blank panel, modules D, A, C in slots 1 to 6, respectively. Besides the blank panels in slots 1-3, the example's modules in this case would represent desired DC output voltages as follows: Slot 4 = D for 48V, Slot 5 = A for 3.3V and Slot 6 = C for 24V.

Assembly facility code and customer build ID No. are established during actual power supply assembly.

## 3. Safety specifications

### 3.1 Safety approvals

- UL/CSA 60950-1 2<sup>nd</sup> + A1
- IEC 60950-1 2<sup>nd</sup> + A1
- EN 60950-1 2<sup>nd</sup> + A1
- CE Mark for LVD



Note: Agency approval is limited to 50-60 Hz. If PSU is used on 400 Hz, then unit must be permanently connected to Protective Earth before connecting the supply due to high leakage current.

### 3.2 Insulation Safety Ratings

| TEST POINTS        | MINIMUM TEST VOLTAGE | INSULATION SAFETY RATING |
|--------------------|----------------------|--------------------------|
| Input-to-Chassis   | 2120 Vdc / min. 1s   | Basic Insulation         |
| Input-to-Output    | 4240 Vdc / min. 1s   | Reinforced Insulation    |
| Outputs-to-Chassis | 50 Vdc / min. 1s     | Functional Insulation    |
| Output-to-Output   | 50 Vdc / min. 1s     | Functional Insulation    |

## 4. Environmental and Reliability specifications

### 4.1 Environmental specification

| PARAMETER             | CONDITIONS / DESCRIPTION  | MIN. | NOM. | MAX.   | UNITS |
|-----------------------|---|------|------|--------|-------|
| Cooling               | Internal DC fans, airflow is from the front of the supply and exhausts from the rear connector area |      |      |        |       |
| Audible Noise         | Single unit, 6 modules assembled and full loaded, on a table at 1m distance                         |      | 56   | 70     | dBa   |
| Operating Temperature | Full power; derated linearly from 100% load @ 50°C to 50% load @ 70°C                               | -20  | 25   | 50     | °C    |
| Storage Temperature   |   | -40  |      | 75     | °C    |
| Humidity              | 95% relative humidity @ 25 °C, non-condensing   |      |      |        |       |
| Vibration             | Operating: Swept 5-500-5Hz profile, 3 axis, 5 sweep cycles per axis                                 |      |      | 1      | Gpk   |
|                       | Non-operating: Swept 5-500-5Hz profile, 3 axis, 5 sweep cycles per axis                             |      |      | 4      | Gpk   |
| Shock                 | Operating: 11ms, half sine, 10 shocks per face  |      |      | 20     | Gpk   |
|                       | Non-operating: 11ms, half sine, 3 shocks per face   |      |      | 40     | Gpk   |
| Altitude              | Operating altitude  |      |      | 10,000 | Ft.   |

### 4.2 Reliability

| PARAMETER         | CONDITIONS / DESCRIPTION                      | MIN.    | NOM. | MAX. | UNITS |
|-------------------|---|---------|------|------|-------|
| Calculated MTBF   | According to MIL-HDBK217, Ground benign 30 °C | 250,000 |      |      | hours |
| Demonstrated MTBF | Tamb=25°C                                     | 250,000 |      |      | hours |

## 5. Fault Protection

| PARAMETER                     | CONDITIONS / DESCRIPTION  | MIN.                                   | NOM. | MAX. | UNITS    |
|-------------------------------|---|--|------|------|----------|
| Input Fuse                    | One fuse, non-user serviceable, located on line leg of AC input, Fast Acting type |  | 20   |      | A        |
| Inrush Current Limitation     | Provided by NTC   | See <i>Input specification</i> section |      |      |          |
| Short Circuit Protection      | Provided by Current Limit circuit   |  |      | 120  | % Io_nom |
| Output Overvoltage Protection | Hiccup on 5 and 12V Modules<br>Latching on 24V and 48V modules                    | 10                                     |      | 25   | % Vo_nom |
| Over Temperature              | By nominal load, OT with auto restart   |  | 60   | 65   | °C amb   |

## 6. EMC specifications

### 6.1 EMC Immunity

| PARAMETER                          | CONDITIONS / DESCRIPTION  | CRITERION            |
|------------------------------------|---|----------------------|
| Electrostatic Discharge (ESD)      | IEC/EN61000-4-2; GR-1089 R2-1, R2-2, R2-3<br>Level 4: contact: $\pm 8$ kV, air: $\pm 15$ kV   | Perform, criterion B |
| RF Susceptibility                  | IEC/EN 61000-4-3;<br>Level 3: 10 V/m; 80 MHz to 1000 MHz;<br>AM 80%, 1 kHz radiated; RF electromagnetic field                               | Perform, criterion A |
| Fast transient / burst             | IEC/EN 61000-4-4; Level 3; $\pm 2$ kV, 5kHz<br>electrical fast transient / burst immunity test  | Perform, criterion B |
| Surge                              | IEC61000-4-5, level 3; line to earth: $\pm 2$ kV, line to line: $\pm 1$ kV<br>surge immunity test   | Perform, criterion B |
| RF conducted disturbance           | IEC/EN 61000-4-6; Level 3; GR-108;<br>10V, 0.15 to 80MHz, AM 80%, 1kHz  | Perform, criterion A |
| Voltage dips / short interruptions | IEC/EN 61000-4-11; Voltage dips, interruptions and variations.<br>(Interpretation: dip below $V_i$ min with $P_o$ nom = hold-up time 10 ms) |                      |
|                                    | 1a: Dip 30%, 100ms  | Perform, criterion B |
|                                    | 1a: Dip 30%, 200ms  | Perform, criterion B |
|                                    | 1a: Dip 60%, 10ms   | Perform, criterion A |
|                                    | 1a: Dip 60%, 100ms  | Perform, criterion B |
|                                    | 1a: Dip >95%, 10ms (interruption)   | Perform, criterion A |
|                                    | 1a: Dip >95%, 100ms (interruption)  | Perform, criterion B |

### 6.2 EMC Emission

| PARAMETER                          | CONDITIONS / DESCRIPTION  | CRITERION                                      |
|------------------------------------|---|--|
| Conducted Emission<br>EN55022, FCC | EN 55022, FCC – EN 55022, and CISPR 22 Class B,<br>FCC 47CFR15 unintentional radiators; standalone at all nominal<br>input voltages and measured in $P_o1$ : 0, 50%, 100%;<br>signal connections open | Class B;<br>min. 3dB/ $\mu$ V margin           |
| Radiated Emission<br>EN55022, FCC  | EN 55022, FCC – EN 55022, and CISPR 22 Class B,<br>FCC 47CFR15 unintentional radiators; standalone at all nominal<br>input voltages and measured in $P_o1$ : 0, 50%, 100%;<br>signal connections open | Radiated Class B QSP / AVG<br>min. 3 dB margin |
| Input Current<br>Harmonics         | EN 61000-3-2, sine wave input, Class D; measured standalone<br>at all $V_{in}$ nominal at power levels between 0 and rated  | Pass   |

## 7. Electrical specifications

### 7.1 Input Specification

| PARAMETER               | CONDITIONS / DESCRIPTION   | MIN. | NOM.      | MAX.             | UNITS |
|-------------------------|--|------|-----------|------------------|-------|
| Input AC Voltage Range  | Continuous Voltage Range<br>Po=1100W from 85-100 VAC<br>Po=1300W from 100-150 VAC<br>Po=1600W from 150-264 VAC           | 85   | 115/230   | 264              | VAC   |
| Input DC Voltage Range  | Po=1100W from 120-140 VDC<br>Po=1300W from 140-210 VDC<br>Po=1600W from 210-380 VDC                                      | 120  |           | 380              | VDC   |
| Input Overvoltage Range | At max. power, no input OVP shutdown   |      |           | 300              | VAC   |
| Ground continuity       |  |      |           | 0.1 <sup>1</sup> | Ohm   |
| Leakage Current         | @ 264 VAC, 60Hz, Standard Commercial   |      |           | 1.5              | mA    |
| Frequency               | AC line  | 47   | 50/60/400 | 440              | Hz    |
| Power Factor            | Active PFC meets requirements of EN 61000-3-2 at full load ,120/230 VAC input  | 0.98 |           |                  |       |
| Input Current           | Steady state, 85 VAC at 1100W  |      |           | 16               | A rms |
| Inrush Current          | 180 VAC, Max Power, 25°C,<br>acc. prETS300-132-1<br>230 VAC, Max Power, 25°C,<br>acc. prETS300-132-1 (Repeat rate >1min) |      | 60        |                  | A pk  |
| Efficiency <sup>2</sup> | Vi = 230 VAC 100% loading  | 85   | 86        |                  | %     |
|                         | Vi = 230 VAC 30-80% loading  | 81   | 82        |                  | %     |
|                         | Vi = 115 VAC 100% loading  | 82   | 83        |                  | %     |
|                         | Vi = 115 VAC 30-80% loading  | 78   | 79        |                  | %     |

<sup>1</sup> For any combination of output modules, any valid load and voltage setting

<sup>2</sup> Efficiency typical for standard configuration AABBCD and nominal output voltage settings

**7.2 Output Specification**

| PARAMETER                    | CONDITIONS/DESCRIPTION  | MIN.                         | NOM. | MAX.         | UNITS    |
|------------------------------|---|------------------------------|------|--------------|----------|
| Output Power                 | Two fans for internal cooling   |                              | 1600 |              | W        |
| Output DC Voltages / Modules | All output modules work in any chassis position and are max 1U high PCB-based   | -                            |      |              |          |
| Current Share                | Active single-wire current share. Maximum difference in currents between two modules – percentage of one module nominal current.    |                              |      | ±10          | %        |
| Line Regulation              | Input from 85 to 264 VAC , 80% load   |                              | 1.0  |              | % Vo_nom |
| Load Regulation              | From 0-100% load, Input >180VAC, Vo_nom   |                              | 1.0  |              | % Vo_nom |
| Thermal Drift                | After 15 minute warm-up period  |                              | 0.02 |              | %/°C     |
| Total Regulation             | Variation of line, load and temperature drift   |                              | 2.0  |              | % Vo_nom |
| Output Adjustment Range      |   | See Module Selection Table 1 |      |              |          |
| Dynamic Response             | Deviation for 10-90% or 90-10% load changes at a rate of 1A/μs, (constant current mode, Vo reach 1% band around V <sub>o</sub> set) |                              |      | 4%<br>2000μs | -        |
|                              | Deviation for 50-100% or 100-50% load steps with 1A/μs rate. (constant current mode, Vo reach 1% band around V <sub>o</sub> set)    |                              |      | 3%<br>400μs  | -        |
| Output Ripple & Noise        | BW = 20MHz; Filter 10nF/10uF; over line and load, 25°C  |                              |      | 1% of Vo_nom | mVpk-pk  |
| CM Noise                     | Output to chassis, over line and load (Measured across 50 Ohms, with 10μH / 10nF in parallel)                                       |                              | 220  | 500          | mVpp     |
| Overshoot                    | Output voltage overshoot at turn-on   |                              | 4    |              | % Vo_nom |
| Turn-On Characteristics      | Turn ON at minimum and nominal output current   | Monotonic characteristic     |      |              | -        |
| Turn-Off Characteristics     | Turn OFF at minimum and nominal output current  | Monotonic characteristic     |      |              | -        |
| Turn-On Time                 | Time required for output within regulation after initial application of AC input  |                              |      | 1.5          | s        |
|                              | Time required for output within regulation after removing inhibit   |                              |      | 100          | ms       |
| Hold-up Time                 | Vo is required to stay within 95% regulation after AC is removed. Measured from the last AC peak, VAC min and full load.            | 10                           |      |              | ms       |
| Remote Sense                 | Total compensation for cable losses   |                              | 250  | 500          | mV       |

**7.3 Input - Signals, Features and Indicators description**

| Signal Name                               | Pin                      | Description   |
|---|--------------------------|---|
| Auxiliary Output<br>- 5V -                | 1,2 vs<br>3,4<br>(RTN_D) | Output defined when voltage of AC line is over 85VAC. Standby nominal voltage is 5.0V, nominal current is 1.0A. Current protected output over point 1.5A. Pin referenced to logic return RTN_D.   |
| Input AC Indication<br>- PFAIL -          | 5                        | Open Collector output pin with 20mA pull-down capability referenced to logic return RTN_D (TTL logic level).<br>PFAIL OPEN OR HIGH state indicates the warning that the input is out of the limit ( the input voltage falls below 85Vac or rises over 264Vac ) 5 ms before the output goes below the lower regulation limit. PFAIL will turn-off the green Input OK LED.<br>PFAIL LOW state indicates that the input voltage is within the operating range. |
| Fan Fail / OTP Indication<br>- FAN_FAIL - | 6                        | Open Collector output pin with 20mA pull-down capability referenced to logic return RTN_D (TTL logic level).<br>FAN_FAIL OPEN OR HIGH state indicates the fan fail / over temperature condition min. 100 ms before the unit shuts-down. A fan fail / OTP will turn-off the green FAN OK LED.<br>FAN_FAIL LOW state indicates normal fan operation, no OTP.  |

**7.4 Output - Signals, Features and Indicators description**

| Signal Name                         | Pin | Description  |
|-------------------------------------|-----|--|
| Output Good indication<br>- PG_HI - | 5   | Open collector output with 5mA pull-down capability protected by 5.1V zener diode. Referenced to PG_LO.<br>PG_HI OPEN OR HIGH state indicates that the module output voltage is below lower regulation limit. A PG_HI fail state turns the GREEN DC OK LED to RED.<br>PG_HI LOW state indicates that the module output voltage is within normal operation limits.  |
| Output Enable function<br>- EN_HI - | 6   | Input internally pulled up and protected by 5.1V zener diode. Pin sourcing capability is 2mA referenced to EN_LO.<br>EN_HI OPEN OR HIGH state ENABLES the module output.<br>EN_HI LOW state INHIBITES the module output.   |
| Positive sense wire<br>- VS+ -      | 1   | Output voltage sense wire. Internally connected to Vout+ via 51 Ω. It is recommended to connect sense wire at positive load point.   |
| Negative sense wire<br>- VS- -      | 3   | Output voltage sense wire. Internally connected to Vout- via 51 Ω. It is recommended to connect sense wire at negative load point.   |
| Current share<br>- CS -             | 4   | Common wire for parallel connected modules to achieve proper current sharing between the modules. Referenced to PG_LO or EN_LO. Interconnect CS pin on all parallel working modules. Active current share pin enables control of output voltage. Pulling-up this pin to 5V is possible to increase the output voltage. Pull-down of this pin has no effect. Voltage on this pin is 3.0V at nominal module current. |

### 7.5 Visual Alarms description

| Alarm Name    | LED position                                   | Description  |
|---------------|--|--|
| Input AC Good | Front panel – LED2<br>(see figure 6)           | ON state LED indicates operation within specified input voltage range.<br>GREEN LED indicator goes to an OFF condition on PFAIL signal failure state.  |
| Fan Good      | Front panel – LED1<br>(see figure 6)           | ON state LED indicates normal fan operation and no OTP status.<br>GREEN LED indicator goes to an OFF condition on FAN_FAIL / OTP signal failure state. |
| Output Good   | Module connector / rear side<br>(see figure 7) | GREEN LED indicates that module output voltage is within normal operation limits.<br>GREEN LED indicator goes to RED on PG_HI signal failure state.    |

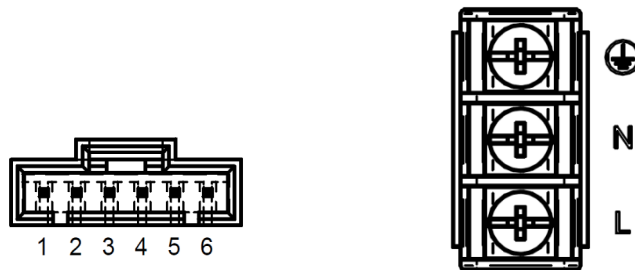
## 8. Connector Details

### 8.1 Input Connector Information

LPM616 front panel connectors pinout refers to *Figure 4* and *chapter 8.2* and *8.3*.

Connector is Cvilux part number: CI3306P1H10, the mating part is Cvilux CI3306S0010, Molex 50-57-9406 or Taiwan King Pin P553L-06(LF).

Note: See *chapter 10.1 Mating Connections and cables* for Input cable information.



**Figure 4. LPM616 Front Panel Connectors Pinout View**

### 8.2 Input Connector - Power Pinout, Screws M4 x 6 mm

| Signal Name | Pin # | Type                 | Recommended wires  | V max<br>I max      |
|-------------|-------|----------------------|--|---------------------|
| Earth       | ⊕     | Earth / Chassis      | Min. 1,5 mm <sup>2</sup><br>e.g. <a href="#">Interpower 86230120</a><br>Max. torque on screws:<br>1,5 Nm | 264 Vrms<br>16 Arms |
| AC Neutral  | N     | Input Power AC       |  |                     |
| AC Line     | L     | Input Power AC Fused |  |                     |

Caution: During the operation must be the input power connector protected by the plastic cover! The cover may be removed ( by the help of a screwdriver ) only when the input cable is disconnected from the mains.

**8.3 Signal Connector – Pinout (Mating connector: Molex 50-57-9406, pins: Molex 16-02-0082)**

| Signal Name | Pin # | Wire Color | Type                            | Signal reference | Low level<br>High level    | V max<br>I max               |
|-------------|-------|------------|---------------------------------|------------------|----------------------------|------------------------------|
| +5V         | 1     | Red        | Aux Output                      | RTN_D            | -                          | 5.0Vdc<br>1.0A <sub>dc</sub> |
| +5V         | 2     | Red        | Aux Output                      | RTN_D            | -                          |                              |
| RTN_D       | 3     | Black      | Logic Reference Potential       | -                | -                          | -                            |
| RTN_D       | 4     | Black      | Logic Reference Potential       | -                | -                          | -                            |
| PFAIL       | 5     | Yellow     | Open Collector Output + ZD 5.6V | RTN_D            | <400mV@<br>20mA<br>Pull up | -<br>20mA                    |
| FAN_FAIL    | 6     | Green      | Open Collector Output + ZD 5.6V | RTN_D            | <400mV@<br>20mA<br>Pull up | -<br>20mA                    |

**8.4 Module Outputs A, B Bus-Bar Pinout**

| Signal Name | Pin # | Type            | Signal reference | Low level<br>High level | V max<br>I max                  |
|-------------|-------|-----------------|------------------|-------------------------|---------------------------------|
| Vout+       | Vout+ | Output Power DC | Vout-            | -                       | See Module<br>Selection Table 1 |
| Vout-       | Vout- | Output Power DC | -                | -                       | See Module<br>Selection Table 1 |

**8.5 Module Output C Signal Connector Pinout**

The output C connector provides signal information across its 8-pin output.

Connector type: JST S08B-PUDSS-1

Mating part: JST housing PUDP-08V-S, pins SPUD-001T-P0.5 (AWG 26-22) or SPUD-002T-P0.5 (AWG 28-24)

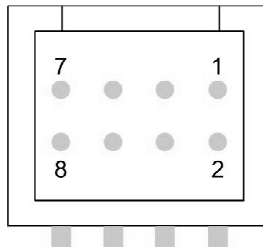


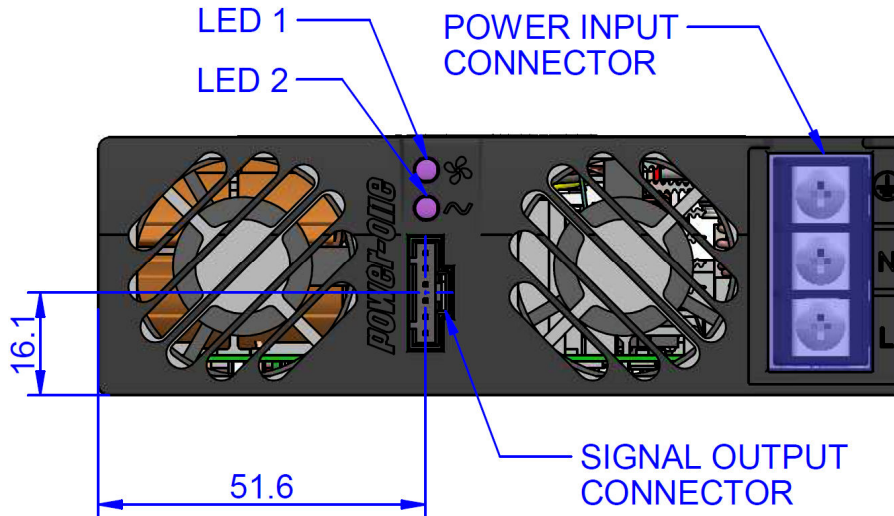
Figure 5. Module Output C Signal Connector Pinout

| Signal Name | Pin # | Type   | Signal reference | Low level<br>High level | V max<br>I max |
|-------------|-------|--|------------------|-------------------------|----------------|
| VS+         | 1     | Output voltage sense wire.<br>Internally connected to Vout+ via<br>51 $\Omega$ . | Vout+            | -                       | 0.5V<br>10mA   |
| PG_LO       | 2     | Reference for PG_HI internally<br>connected to signal ground.                    | -                | -                       | -<br>10mA      |
| VS-         | 3     | Output voltage sense wire.<br>Internally connected to Vout- via<br>51 $\Omega$ . | Vout-            | -                       | 0.5V<br>10mA   |
| CS          | 4     | Active Current Share pin.  | PG_LO / EN_LO    | -                       | 5V<br>-        |
| PG_HI       | 5     | Open collector output, protected<br>by 5.1V zener diode.                         | PG_LO / EN_LO    | <400mV@5mA<br>Pull up   | -<br>5mA       |
| EN_HI       | 6     | Input internally pulled up and<br>protected by 5.1V zener diode.                 | PG_LO / EN_LO    | <400mV@2mA<br>Open      | -<br>2mA       |
| EN_LO       | 7     | Reference for EN_HI internally<br>connected to signal ground.                    | -                | -                       | -<br>10mA      |
| N/C         | 8     | -  | -                | -                       | -              |

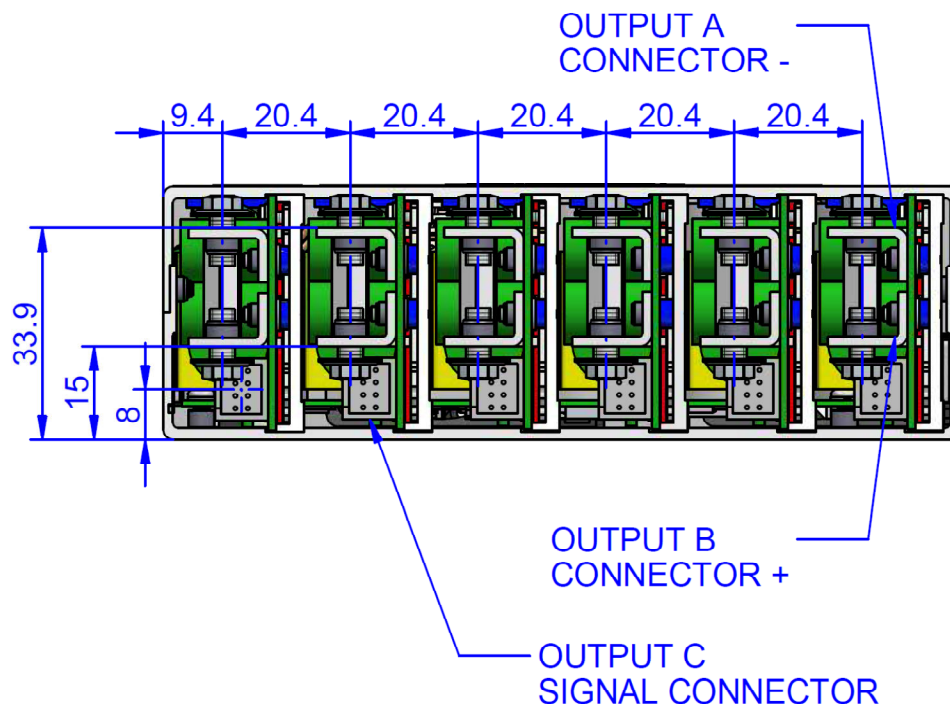
**9. Mechanical Drawings**

- **Overall Dimensions:** 11.9" x 5" x 1.6" (303.7 x 127 x 40.64mm)
- **Weight:** 1.94 kg (including 6 modules)

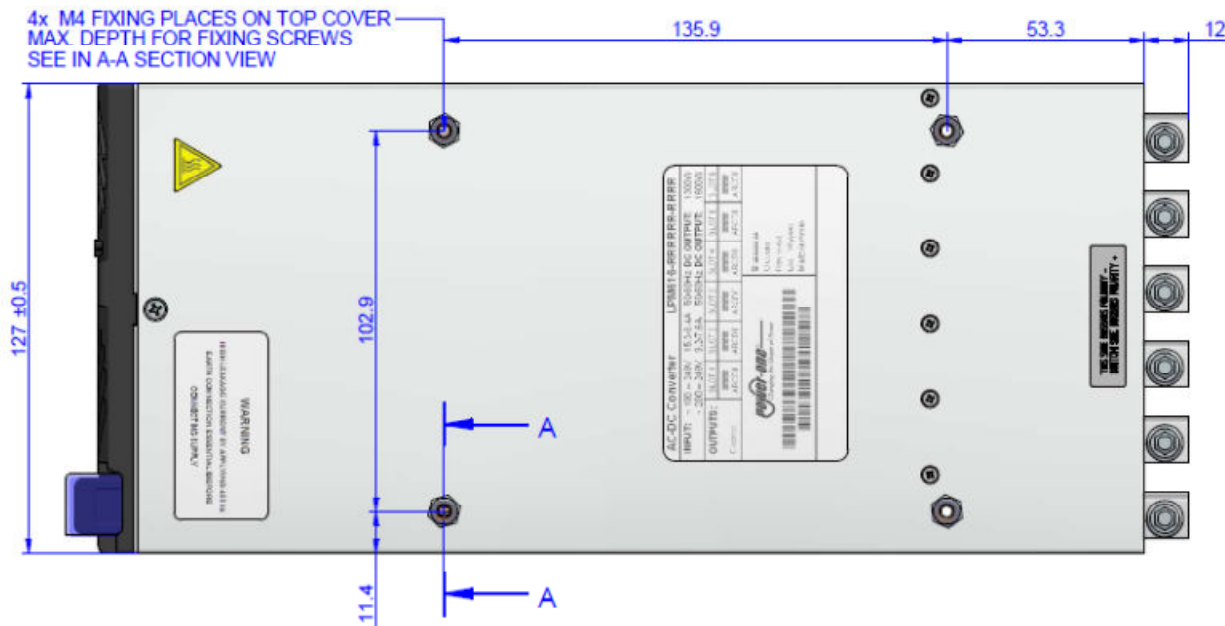
All drawing dimensions are shown in millimeters, unless otherwise notated.



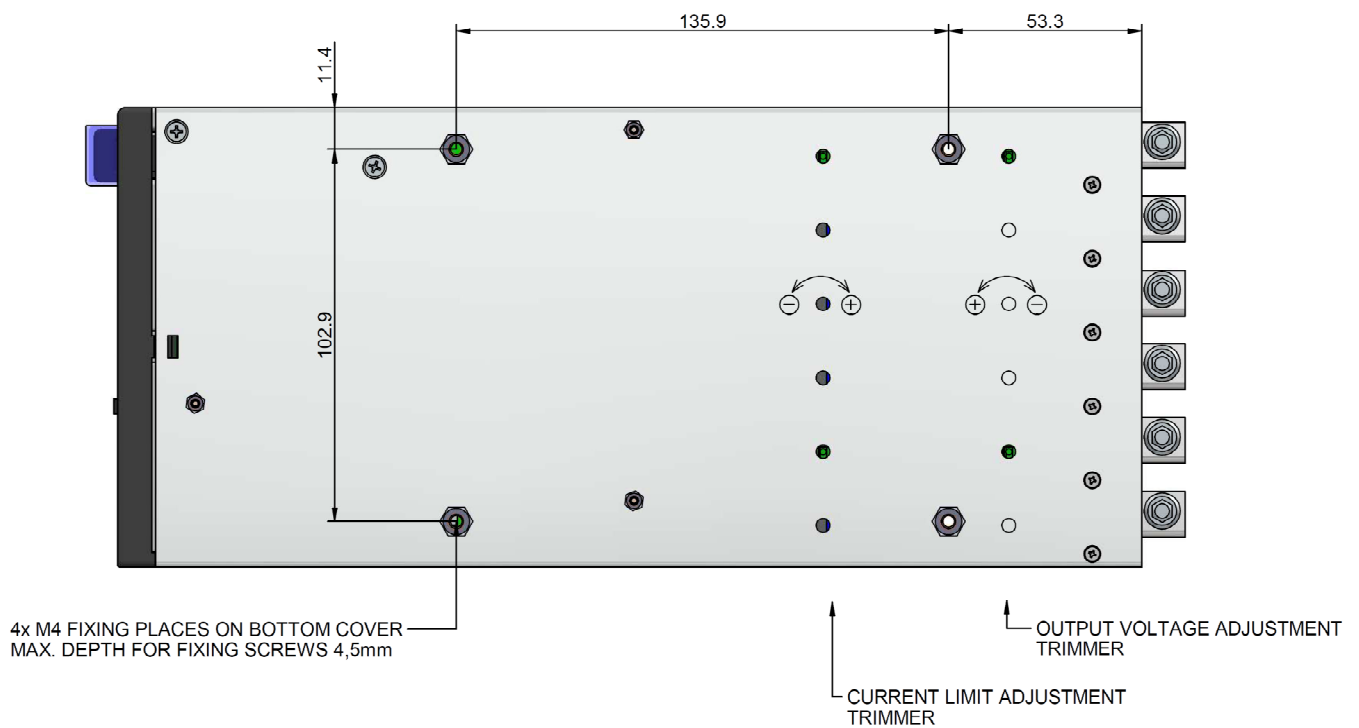
**Figure 6. Front View**



**Figure 8. Side View**



**Figure 9. Top View**



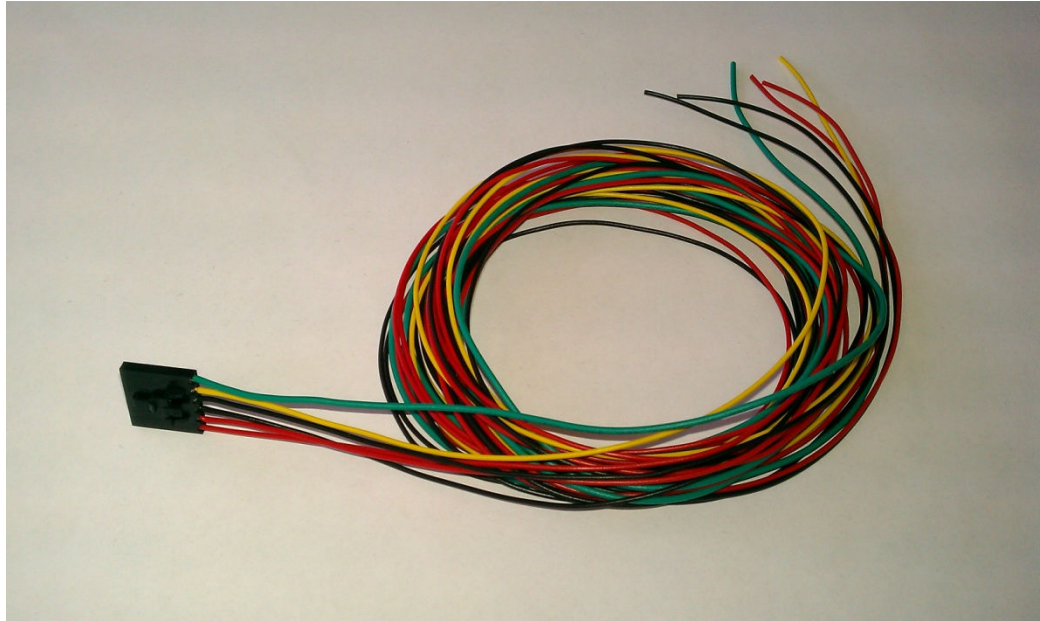
**Figure 10. Bottom View**

## 10. Accessories

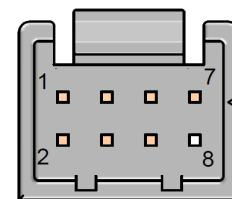
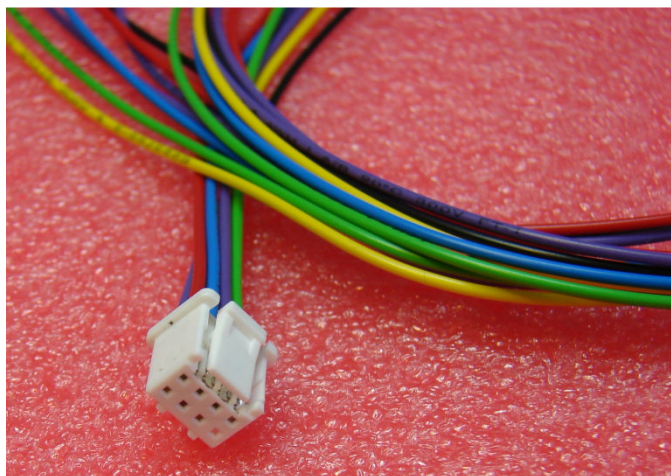
### 10.1 Mating Connections and Cables

All the power and signal cables and mating connectors are not included in the LPM616 standard package. These all need to be extra ordered.

- Front panel Signal cable: Power-One accessory LPM000-LEAD-03, see *figure 11*.
- Output Signal cable: Power-One accessory LPM000-LEAD-02, see *figure 12*.
- Output signal mating connector: JST-PU2P-08-S, JST-SPUD-001T-P0.5
- Output Power Cable: 14AWG – 10AWG depend on the output current, min. 85°C thermal class



**Figure 11. LPM000-LEAD-03 Output Leads**



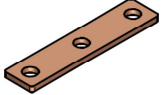
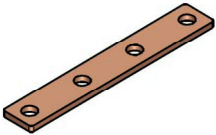
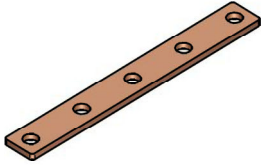
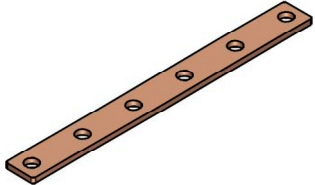


**Figure 12. LPM000-LEAD-02 Output Leads**

**10.2 Signal Output wire colors**

| Pin # | Signal Name | Wire Color |
|-------|-------------|------------|
| 1.    | VS+         | Red        |
| 2.    | PG_LO       | Violet     |
| 3.    | VS-         | Blue       |
| 4.    | CS          | Yellow     |
| 5.    | PG_HI       | Violet     |
| 6.    | EN_HI       | Black      |
| 7.    | EN_LO       | Green      |
| 8.    | N/C         | -          |

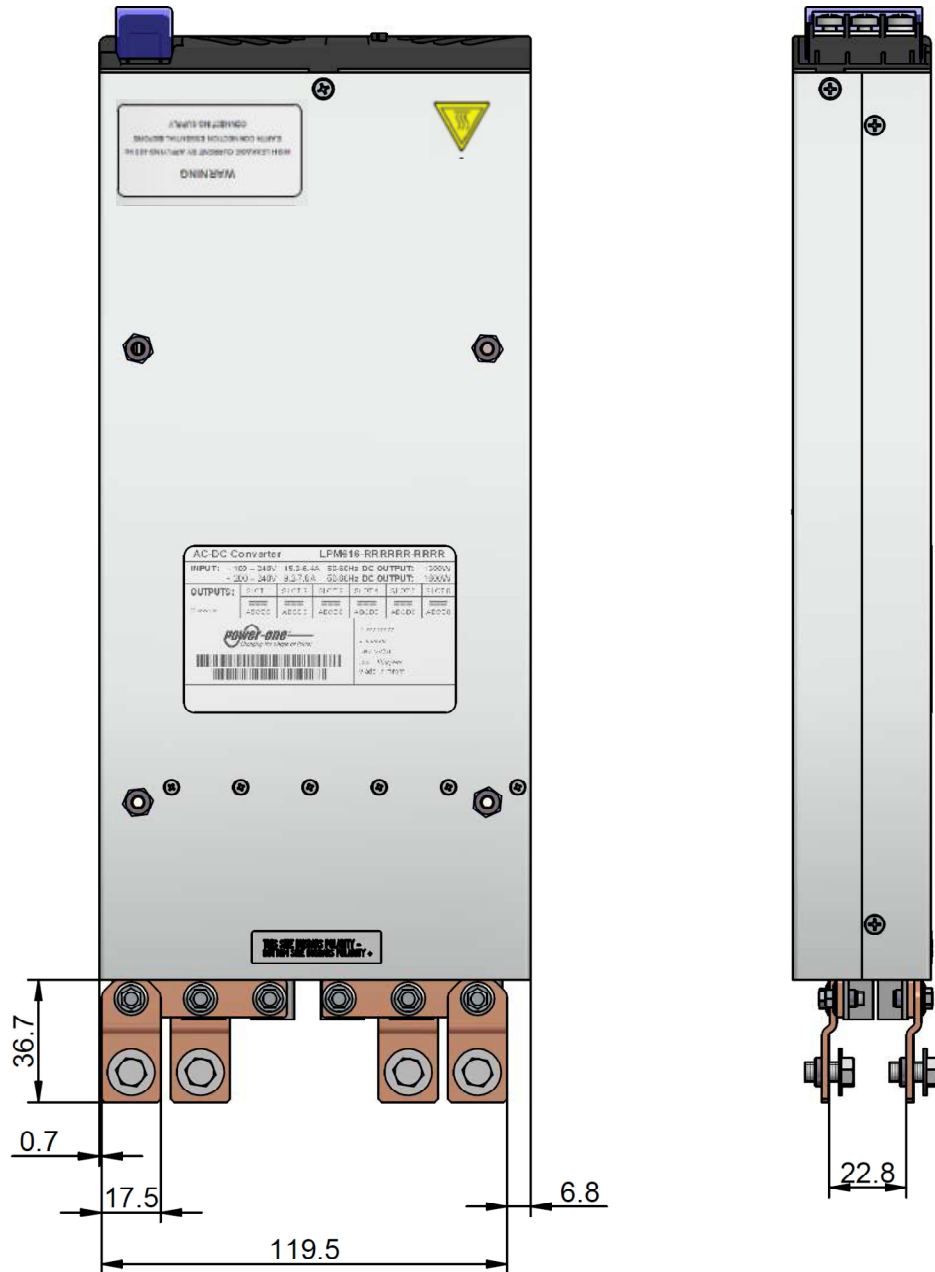
**10.3 Paralleling Busbars**

| Item           | Description  | Model   |
|----------------|--|---|
| LPM000-BBAR-01 | Busbar with 1 opening for module connection and one for cable connection screw M6x8mm, max. 250A. <sup>1</sup> |    |
| LPM000-BBAR-02 | Busbar for parallel connection of two modules.   |  |
| LPM000-BBAR-03 | Busbar for parallel connection of three modules.   |  |
| LPM000-BBAR-04 | Busbar for parallel connection of four modules.  |  |
| LPM000-BBAR-05 | Busbar for parallel connection of five modules.  |  |
| LPM000-BBAR-06 | Busbar for parallel connection of six modules.   |  |

Notes: <sup>1</sup> For load current over 250A use two of LPM000-BBAR-01 and two cables for each pole.

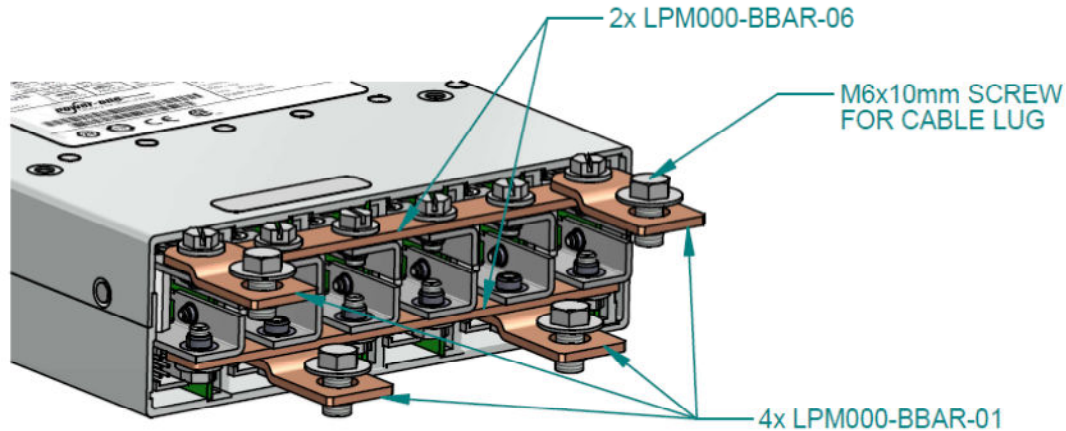
<sup>2</sup> by using busbars (paralleling modules) you will need also the signal output leads LPM000-LEAD-02, one for each module connected by the same busbar . The interconnection is shown in Fig.16 (especially all pins 4 - CS and all pins 2,7 – SGND must be reconnected).

The example of LPM616-AAABBB-DXXX assembly configuration is on the *Figure 13*.



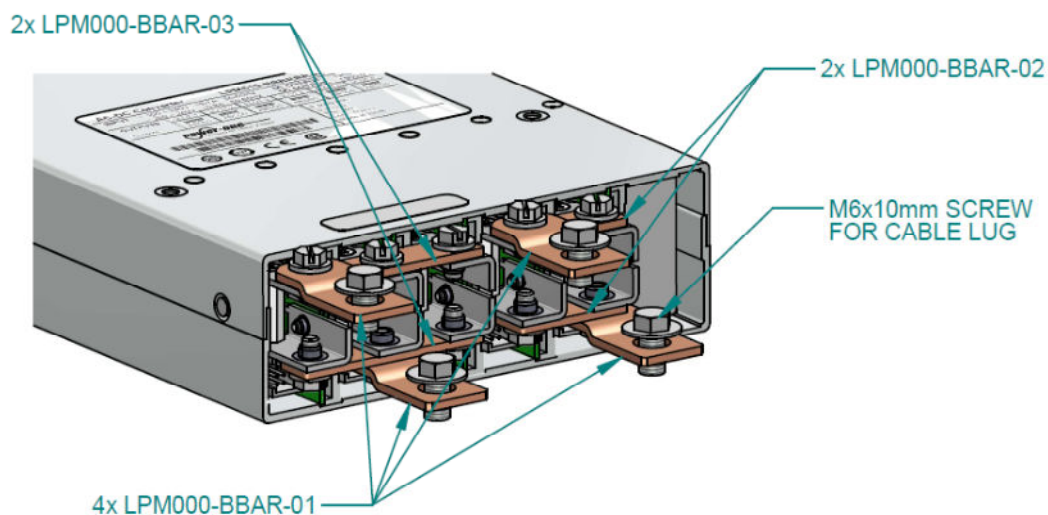
**Figure 13. LPM616-AAABBB-DXXX parallel configuration**

Note that for 300A output current (LPM616-AAAAAA-DXXX on *Figure 14* ) this is the most preferred arrangement to achieve the best thermal flow. Connect two power cables for each pole ( $2 \times 70\text{mm}^2$ ). Use 105°C thermal class isolation.

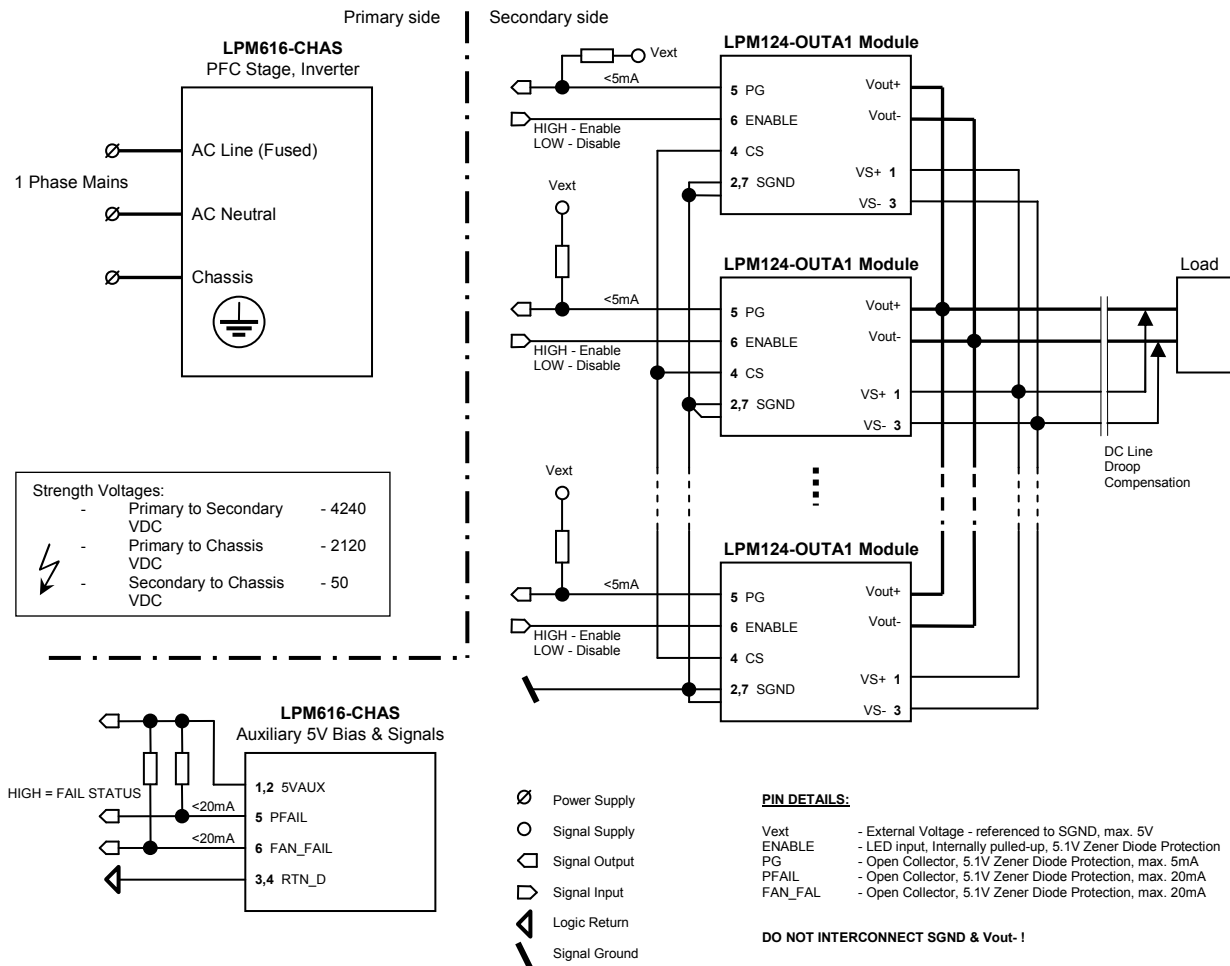


**Figure 14. LPM616-AAAAAA-DXXX Output Busbars arrangement**

Another example of configuration LPM616-BBCC0-DXXX is shown on *Figure 15*.



**Figure 15. LPM616-BBCC0-DXXX Output Busbars arrangement**



**Figure 16. LPM616 – Paralleling Connection Diagram**

**NUCLEAR AND MEDICAL APPLICATIONS** - Power-One products are not designed, intended for use in, or authorized for use as critical components in life support systems, equipment used in hazardous environments, or nuclear control systems without the express written consent of the respective divisional president of Power-One, Inc.

**TECHNICAL REVISIONS** - The appearance of products, including safety agency certifications pictured on labels, may change depending on the date manufactured. Specifications are subject to change without notice.