

LMV651/LMV652/LMV654 12 MHz, Low Voltage, Low Power Amplifiers

 Check for Samples: [LMV651](#), [LMV652](#), [LMV654](#)

FEATURES

(Typical 5V Supply, Unless Otherwise Noted.)

- Specified 3.0V and 5.0V Performance
- Low Power Supply Current
 - LMV651 116 μ A
 - LMV652 118 μ A per Amplifier
 - LMV654 122 μ A per Amplifier
- High Unity Gain Bandwidth 12 MHz
- Max Input Offset Voltage 1.5 mV
- CMRR 100 dB
- PSRR 95 dB
- Input Referred Voltage Noise 17 nV/ $\sqrt{\text{Hz}}$
- Output Swing with 2 k Ω Load 120 mV from Rail
- Total Harmonic Distortion 0.003% at 1 kHz, 2 k Ω
- Temperature Range -40°C to 125°C

APPLICATIONS

- Portable Equipment
- Automotive
- Battery Powered Systems
- Sensors and Instrumentation

DESCRIPTION

TI's LMV651/LMV652/LMV654 are high performance, low power operational amplifier ICs implemented with TI's advanced VIP50 process. This family of parts features 12 MHz of bandwidth while consuming only 116 μ A of current, which is an exceptional bandwidth to power ratio in this op amp class. The LMV651/LMV652/LMV654 are unity gain stable and provide an excellent solution for general purpose amplification in low voltage, low power applications.

This family of low voltage, low power amplifiers provides superior performance and economy in terms of power and space usage. These op amps have a maximum input offset voltage of 1.5 mV, a rail-to-rail output stage and an input common-mode voltage range that includes ground. The LMV651/LMV652/LMV654 provide a PSRR of 95 dB, a CMRR of 100 dB and a total harmonic distortion (THD) of 0.003% at 1 kHz frequency and 2 k Ω load.

The operating supply voltage range for this family of parts is from 2.7V and 5.5V. These op amps can operate over a wide temperature range (-40°C to 125°C) making them ideal for automotive applications, sensor applications and portable equipment applications. The LMV651 is offered in the ultra tiny 5-Pin SC70 and 5-Pin SOT-23 package. The LMV652 is offered in an 8-Pin VSSOP package. The LMV654 is offered in a 14-Pin TSSOP package.

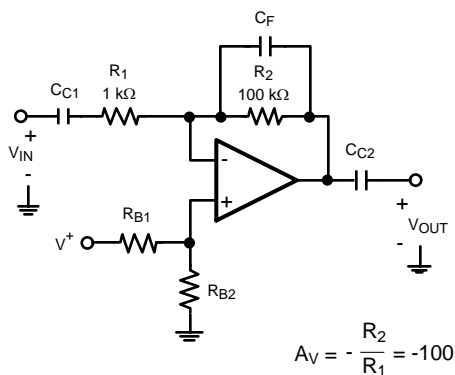

Figure 1. High Gain Wide Bandwidth Inverting Amplifier

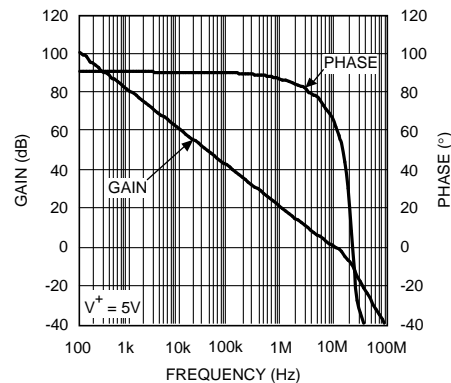

Figure 2. Open Loop Gain and Phase vs. Frequency



Please be aware that an important notice concerning availability, standard warranty, and use in critical applications of Texas Instruments semiconductor products and disclaimers thereto appears at the end of this data sheet.

All trademarks are the property of their respective owners.



These devices have limited built-in ESD protection. The leads should be shorted together or the device placed in conductive foam during storage or handling to prevent electrostatic damage to the MOS gates.

Absolute Maximum Ratings⁽¹⁾⁽²⁾

ESD Tolerance ⁽³⁾	Human Body Model	2000V
	Machine Model	100V
Differential Input V_{ID}		$\pm 0.3V$
Supply Voltage ($V_S = V^+ - V^-$)		6V
Input/Output Pin Voltage		$V^+ +0.3V, V^- -0.3V$
Storage Temperature Range		$-65^\circ C$ to $150^\circ C$
Junction Temperature ⁽⁴⁾		$150^\circ C$
Soldering Information	Infrared or Convection (20 sec)	$235^\circ C$
	Wave Soldering Lead Temperature (10 sec)	$260^\circ C$

- (1) Absolute Maximum Ratings indicate limits beyond which damage to the device may occur. Operating Ratings indicate conditions for which the device is intended to be functional, but specific performance is not ensured. For ensured specifications and the test conditions, see the Electrical Characteristics Tables.
- (2) If Military/Aerospace specified devices are required, please contact the Texas Instruments Sales Office/Distributors for availability and specifications.
- (3) Human Body Model, applicable std. MIL-STD-883, Method 3015.7. Machine Model, applicable std. JESD22-A115-A (ESD MM std. of JEDEC) Field-Induced Charge-Device Model, applicable std. JESD22-C101-C (ESD FICDM std. of JEDEC).
- (4) The maximum power dissipation is a function of $T_{J(MAX)}$, θ_{JA} , and T_A . The maximum allowable power dissipation at any ambient temperature is $P_D = (T_{J(MAX)} - T_A) / \theta_{JA}$. All numbers apply for packages soldered directly onto a PC board.

Operating Ratings⁽¹⁾

Temperature Range ⁽²⁾		$-40^\circ C$ to $125^\circ C$
Supply Voltage		2.7V to 5.5V
Package Thermal Resistance (θ_{JA}) ⁽²⁾	5-Pin SC70	$456^\circ C/W$
	5-Pin SOT-23	$234^\circ C/W$
	8-Pin VSSOP	$234^\circ C/W$
	14-Pin TSSOP	$160^\circ C/W$

- (1) Absolute Maximum Ratings indicate limits beyond which damage to the device may occur. Operating Ratings indicate conditions for which the device is intended to be functional, but specific performance is not ensured. For ensured specifications and the test conditions, see the Electrical Characteristics Tables.
- (2) The maximum power dissipation is a function of $T_{J(MAX)}$, θ_{JA} , and T_A . The maximum allowable power dissipation at any ambient temperature is $P_D = (T_{J(MAX)} - T_A) / \theta_{JA}$. All numbers apply for packages soldered directly onto a PC board.

3V DC Electrical Characteristics

Unless otherwise specified, all limits are specified for $T_A = 25^\circ C$, $V^+ = 3V$, $V^- = 0V$, $V_O = V_{CM} = V^+/2$, and $R_L > 1 M\Omega$.

Boldface limits apply at the temperature extremes.

Symbol	Parameter	Conditions	Min (1)	Typ (2)	Max (1)	Units
V_{OS}	Input Offset Voltage			0.1	± 1.5 2.7	mV
TC V_{OS}	Input Offset Average Drift			6.6		$\mu V/^\circ C$
I_B	Input Bias Current	See ⁽³⁾		80	120	nA
I_{OS}	Input Offset Current			2.2	15	nA
CMRR	Common Mode Rejection Ratio	$0 \leq V_{CM} \leq 2.0 V$	87 80	100		dB

- (1) Limits are 100% production tested at $25^\circ C$. Limits over the operating temperature range are specified through correlations using Statistical Quality Control (SQC) method.
- (2) Typical values represent the most likely parametric norm as determined at the time of characterization. Actual typical values may vary over time and will also depend on the application and configuration. The typical values are not tested and are not ensured on shipped production material.
- (3) Positive current corresponds to current flowing into the device.

3V DC Electrical Characteristics (continued)

Unless otherwise specified, all limits are specified for $T_A = 25^\circ\text{C}$, $V^+ = 3\text{V}$, $V^- = 0\text{V}$, $V_O = V_{CM} = V^+/2$, and $R_L > 1\text{M}\Omega$.

Boldface limits apply at the temperature extremes.

Symbol	Parameter	Conditions	Min (1)	Typ (2)	Max (1)	Units
PSRR	Power Supply Rejection Ratio	$3.0 \leq V^+ \leq 5\text{V}$, $V_{CM} = 0.5$	87 81	95		dB
		$2.7 \leq V^+ \leq 5.5\text{V}$, $V_{CM} = 0.5$	87 81	95		
CMVR	Input Common-Mode Voltage Range	CMRR $\geq 75\text{ dB}$ CMRR $\geq 60\text{ dB}$	0 0		2.1 2.1	V
A _{VOL}	Large Signal Voltage Gain	$0.3 \leq V_O \leq 2.7$, $R_L = 2\text{ k}\Omega$ to $V^+/2$ $0.4 \leq V_O \leq 2.6$, $R_L = 2\text{ k}\Omega$ to $V^+/2$	80 76	85		dB
		$0.3 \leq V_O \leq 2.7$, $R_L = 10\text{ k}\Omega$ to $V^+/2$ $0.4 \leq V_O \leq 2.6$, $R_L = 10\text{ k}\Omega$ to $V^+/2$	86 83	93		
V _O	Output Swing High	$R_L = 2\text{ k}\Omega$ to $V^+/2$		80	95 120	mV from rail
		$R_L = 10\text{ k}\Omega$ to $V^+/2$		45	50 60	
	Output Swing Low	$R_L = 2\text{ k}\Omega$ to $V^+/2$		95	110 125	
		$R_L = 10\text{ k}\Omega$ to $V^+/2$		60	65 75	
I _{SC}	Maximum Continuous Output Current	Sourcing ⁽⁴⁾		17		mA
		Sinking ⁽⁴⁾		25		
I _S	Supply Current per Amplifier	LMV651		115	140 175	μA
		LMV652		118		
		LMV654		122		
SR	Slew Rate	$A_V = +1$, 10% to 90% ⁽⁵⁾		3.0		V/ μs
GBW	Gain Bandwidth Product			12		MHz
e _n	Input-Referred Voltage Noise	f = 100 kHz		17		nV/ $\sqrt{\text{Hz}}$
		f = 1 kHz		17		
i _n	Input-Referred Current Noise	f = 100 kHz		0.1		pA/ $\sqrt{\text{Hz}}$
		f = 1 kHz		0.15		
THD	Total Harmonic Distortion	f = 1 kHz, $A_V = 2$, $R_L = 2\text{ k}\Omega$		0.003		%

(4) The part is not short circuit protected and is not recommended for operation with low resistive loads. Typical sourcing and sinking output current curves are provided in the Typical Performance Characteristics and should be consulted before designing for heavy loads.

(5) Slew rate is the average of the rising and falling slew rates.

5V DC Electrical Characteristics

Unless otherwise specified, all limits are specified for $T_J = 25^\circ\text{C}$, $V^+ = 5\text{V}$, $V^- = 0\text{V}$, $V_O = V_{CM} = V^+/2$, and $R_L > 1\text{M}\Omega$. **Boldface** limits apply at the temperature extremes.

Symbol	Parameter	Conditions	Min (1)	Typ (2)	Max (1)	Units
V _{OS}	Input Offset Voltage			0.1	± 1.5 2.7	mV
TC V _{OS}	Input Offset Average Drift			6.6		$\mu\text{V}/^\circ\text{C}$
I _B	Input Bias Current	See ⁽³⁾		80	120	nA
I _{OS}	Input Offset Current			2.2	15	nA

(1) Limits are 100% production tested at 25°C . Limits over the operating temperature range are specified through correlations using Statistical Quality Control (SQC) method.

(2) Typical values represent the most likely parametric norm as determined at the time of characterization. Actual typical values may vary over time and will also depend on the application and configuration. The typical values are not tested and are not ensured on shipped production material.

(3) Positive current corresponds to current flowing into the device.

5V DC Electrical Characteristics (continued)

Unless otherwise specified, all limits are specified for $T_J = 25^\circ\text{C}$, $V^+ = 5\text{V}$, $V^- = 0\text{V}$, $V_O = V_{CM} = V^+/2$, and $R_L > 1\text{ M}\Omega$. **Boldface** limits apply at the temperature extremes.

Symbol	Parameter	Conditions	Min (1)	Typ (2)	Max (1)	Units
CMRR	Common Mode Rejection Ratio	$0 \leq V_{CM} \leq 4.0\text{ V}$	90 83	100		dB
PSRR	Power Supply Rejection Ratio	$3\text{V} \leq V^+ \leq 5\text{V}$, $V_{CM} = 0.5\text{V}$	87 81	95		dB
		$2.7\text{V} \leq V^+ \leq 5.5\text{V}$, $V_{CM} = 0.5\text{V}$	87 81	95		
CMVR	Input Common-Mode Voltage Range	CMRR $\geq 80\text{ dB}$ CMRR $\geq 68\text{ dB}$	0 0		4.1 4.1	V
A_{VOL}	Large Signal Voltage Gain	$0.3 \leq V_O \leq 4.7\text{V}$, $R_L = 2\text{ k}\Omega$ to $V^+/2$ $0.4 \leq V_O \leq 4.6$, $R_L = 2\text{ k}\Omega$ to $V^+/2$	79 76	84		dB
		$0.3 \leq V_O \leq 4.7\text{V}$, $R_L = 10\text{ k}\Omega$ to $V^+/2$ $0.4 \leq V_O \leq 4.6$, $R_L = 10\text{ k}\Omega$ to $V^+/2$	87 84	94		
V_O	Output Swing High	$R_L = 2\text{ k}\Omega$ to $V^+/2$		120	140 185	mV from rail
		$R_L = 10\text{ k}\Omega$ to $V^+/2$		75	90 120	
	Output Swing Low	$R_L = 2\text{ k}\Omega$ to $V^+/2$		110	130 150	
		$R_L = 10\text{ k}\Omega$ to $V^+/2$		70	80 95	
I_{SC}	Maximum Continuous Output Current	Sourcing ⁽⁴⁾		18.5		mA
		Sinking ⁽⁴⁾		25		
I_S	Supply Current per Amplifier	LMV651		116	140 175	μA
		LMV652		118		
		LMV654		122		
SR	Slew Rate	$A_V = +1$, $V_O = 1\text{ V}_{PP}$ 10% to 90% ⁽⁵⁾		3.0		V/ μs
GBW	Gain Bandwidth Product			12		MHz
e_n	Input-Referred Voltage Noise	$f = 100\text{ kHz}$		17		nV/ $\sqrt{\text{Hz}}$
		$f = 1\text{ kHz}$		17		
i_n	Input-Referred Current Noise	$f = 100\text{ kHz}$		0.1		$\text{pA}/\sqrt{\text{Hz}}$
		$f = 1\text{ kHz}$		0.15		
THD	Total Harmonic Distortion	$f = 1\text{ kHz}$, $A_V = 2$, $R_L = 2\text{ k}\Omega$		0.003		%

- (4) The part is not short circuit protected and is not recommended for operation with low resistive loads. Typical sourcing and sinking output current curves are provided in the Typical Performance Characteristics and should be consulted before designing for heavy loads.
- (5) Slew rate is the average of the rising and falling slew rates.

Connection Diagram

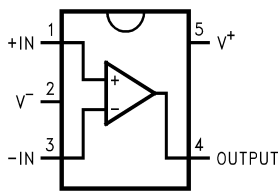

Figure 3. 5-Pin SC70/ SOT-23 Top View

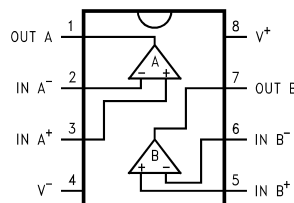

Figure 4. 8-Pin VSSOP Top View

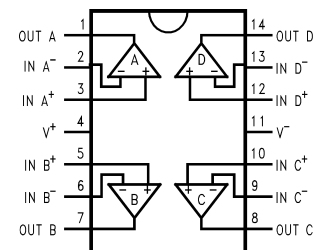

Figure 5. 14-Pin TSSOP Top View

Typical Performance Characteristics

Unless otherwise specified, $T_A = 25^\circ\text{C}$, $V_S = 5\text{V}$, $V^+ = 5\text{V}$, $V^- = 0\text{V}$, $V_{CM} = V_S/2$

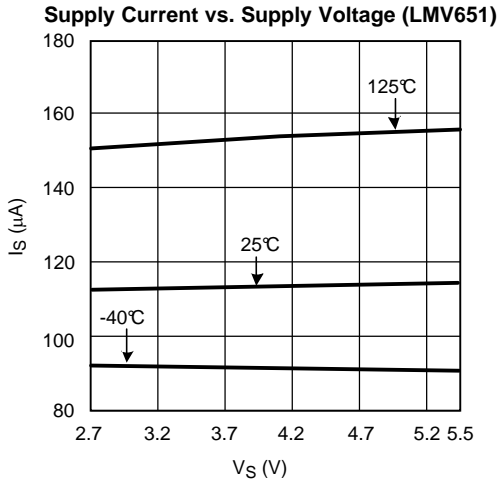

Figure 6.

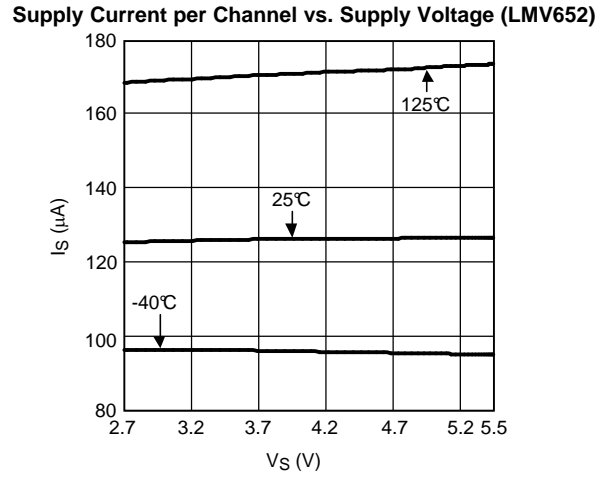

Figure 7.

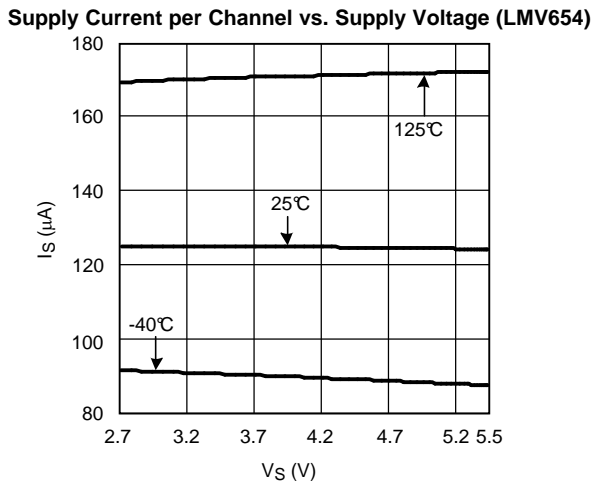

Figure 8.

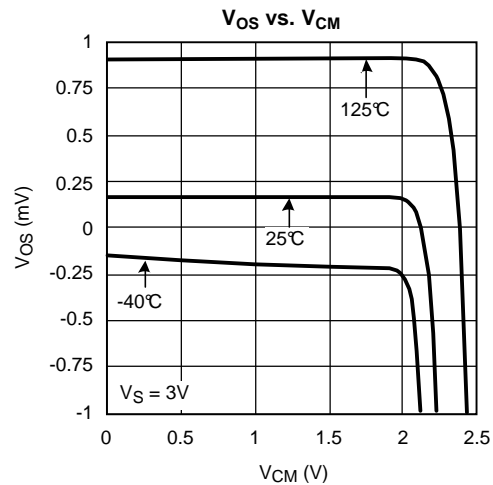

Figure 9.

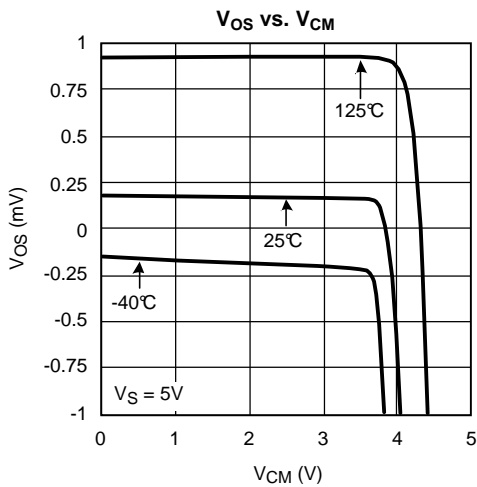

Figure 10.

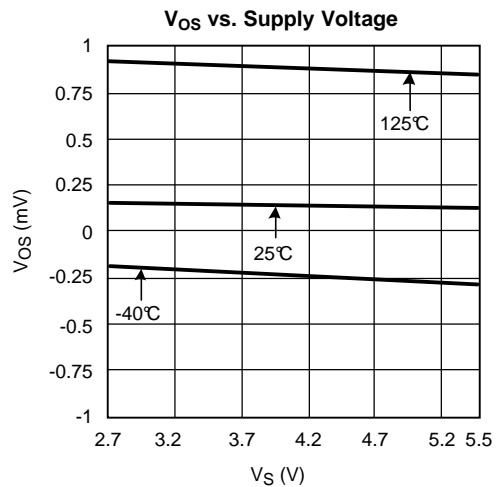

Figure 11.

Typical Performance Characteristics (continued)

Unless otherwise specified, $T_A = 25^\circ\text{C}$, $V_S = 5\text{V}$, $V^+ = 5\text{V}$, $V^- = 0\text{V}$, $V_{CM} = V_S/2$

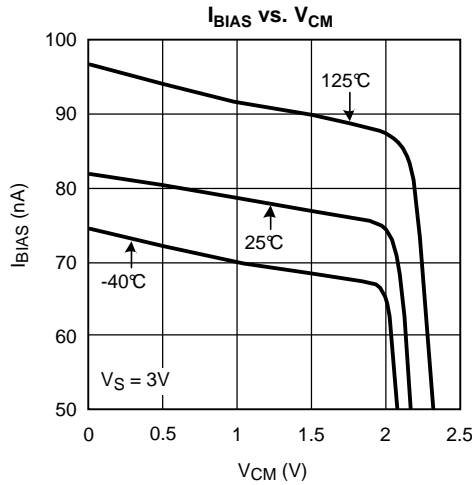

Figure 12.

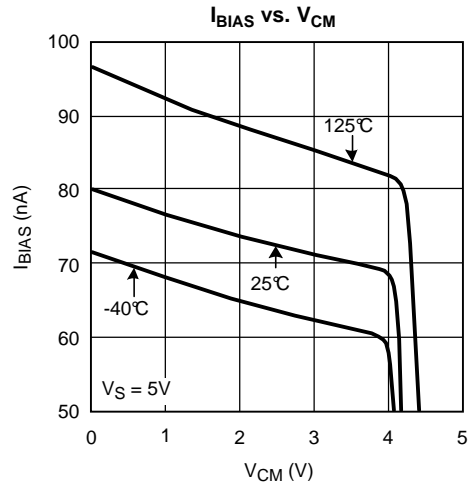

Figure 13.

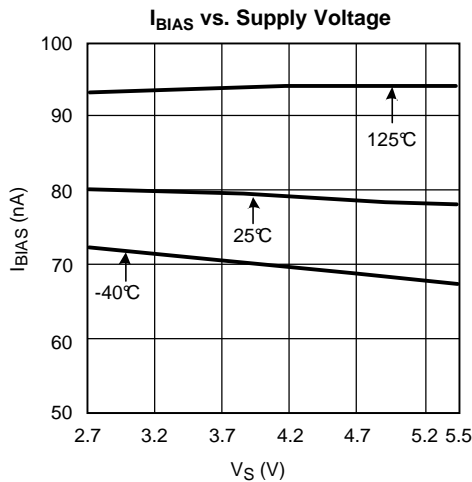

Figure 14.

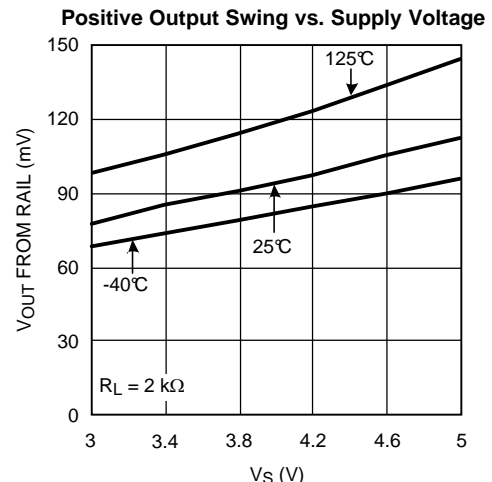

Figure 15.

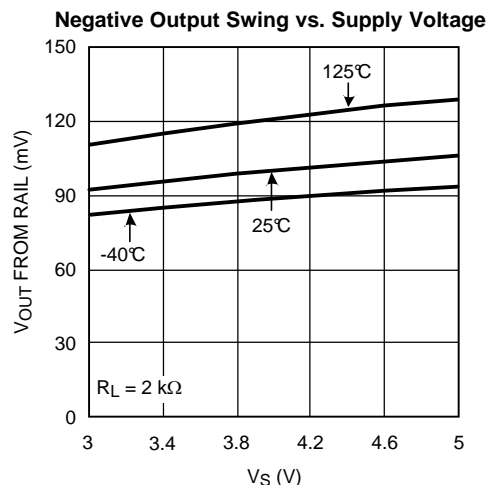

Figure 16.

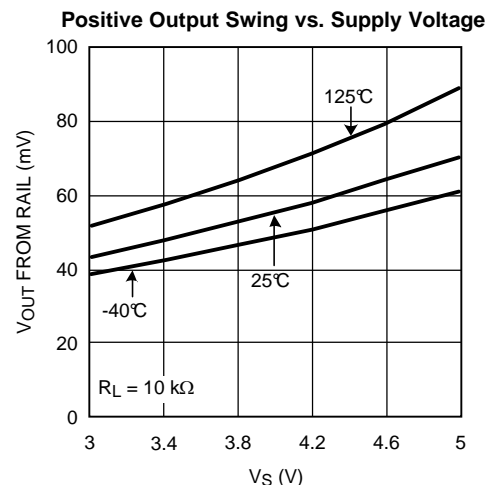

Figure 17.

Typical Performance Characteristics (continued)

Unless otherwise specified, $T_A = 25^\circ\text{C}$, $V_S = 5\text{V}$, $V^+ = 5\text{V}$, $V^- = 0\text{V}$, $V_{CM} = V_S/2$

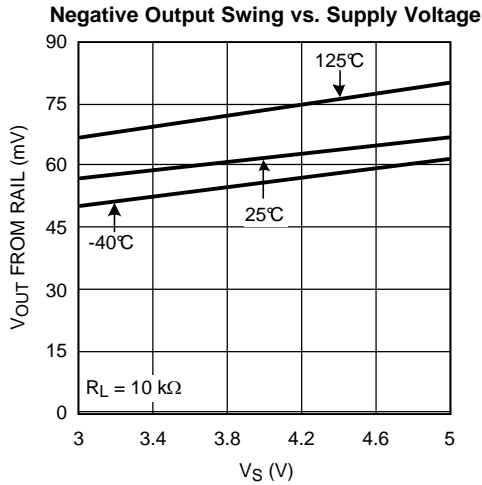

Figure 18.

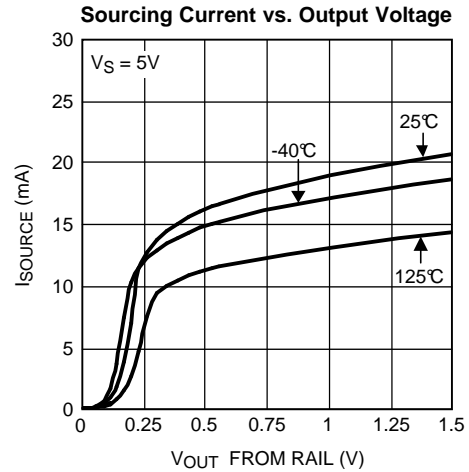

Figure 19.

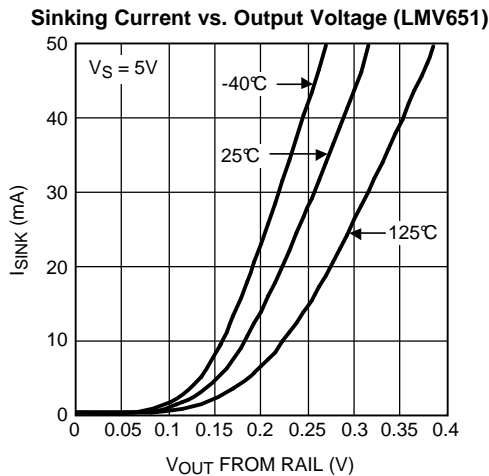

Figure 20.

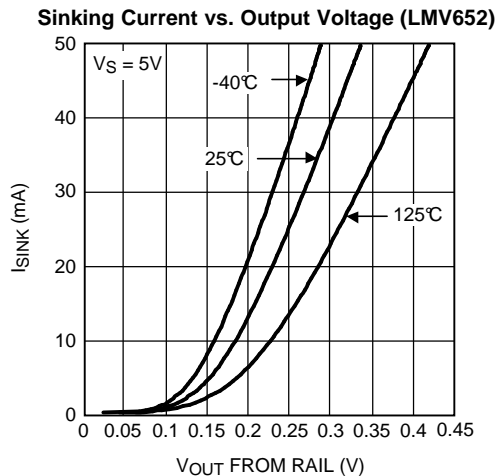

Figure 21.

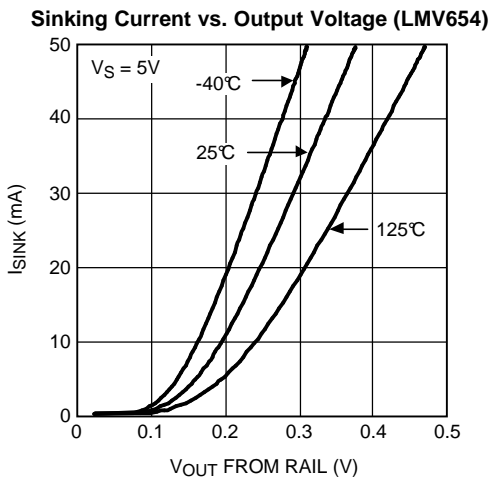

Figure 22.

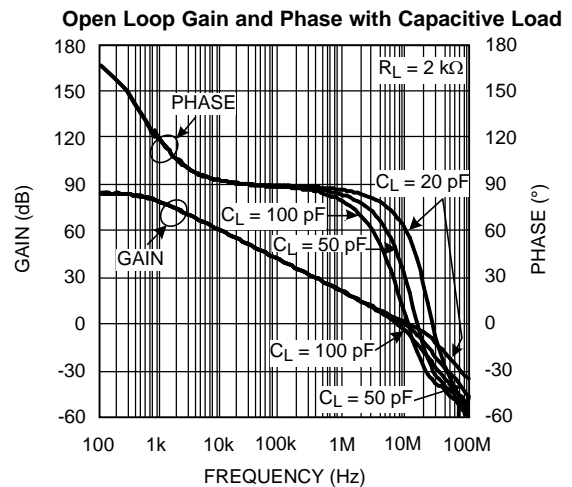

Figure 23.

Typical Performance Characteristics (continued)

Unless otherwise specified, $T_A = 25^\circ\text{C}$, $V_S = 5\text{V}$, $V^+ = 5\text{V}$, $V^- = 0\text{V}$, $V_{CM} = V_S/2$

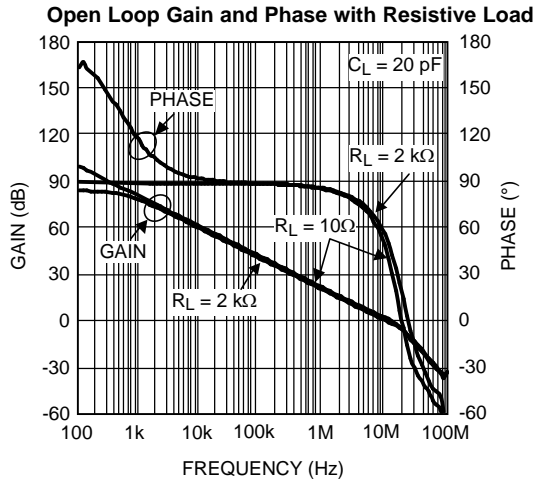

Figure 24.

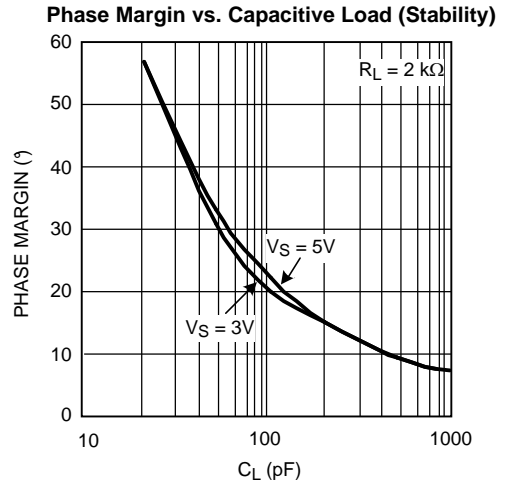

Figure 25.

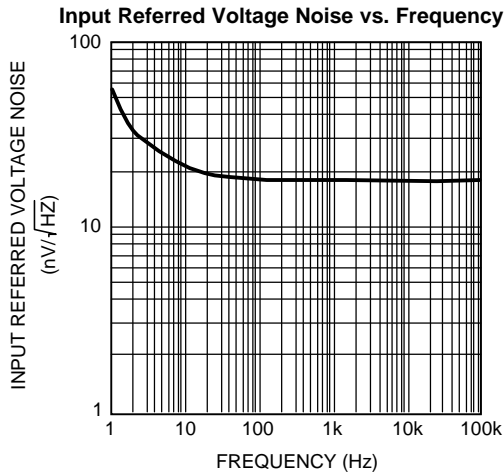

Figure 26.

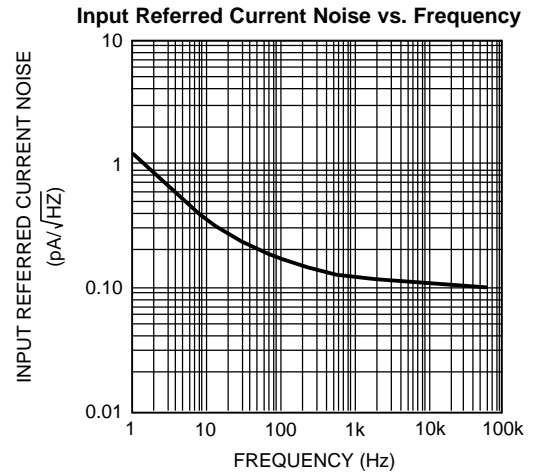

Figure 27.

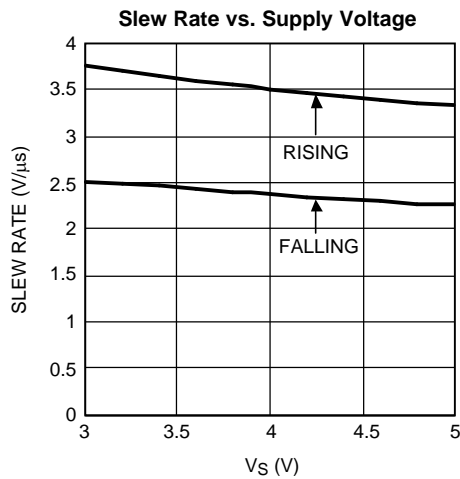

Figure 28.

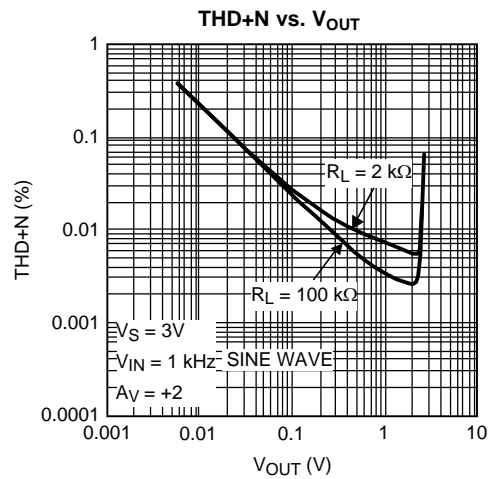

Figure 29.

Typical Performance Characteristics (continued)

Unless otherwise specified, $T_A = 25^\circ\text{C}$, $V_S = 5\text{V}$, $V^+ = 5\text{V}$, $V^- = 0\text{V}$, $V_{CM} = V_S/2$

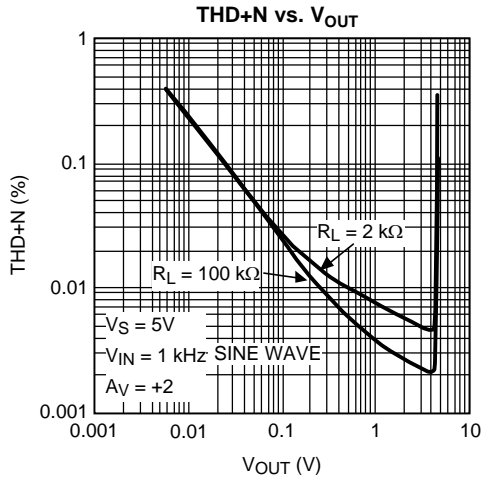

Figure 30.

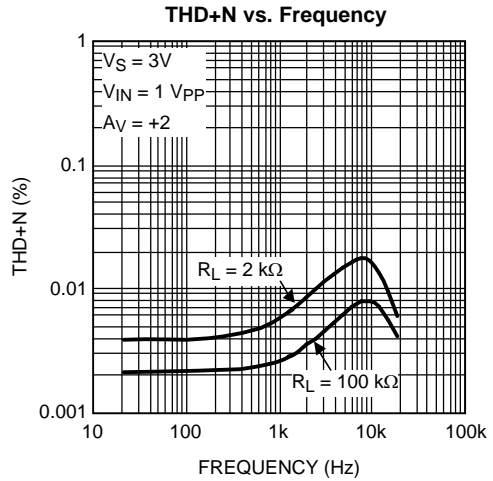

Figure 31.

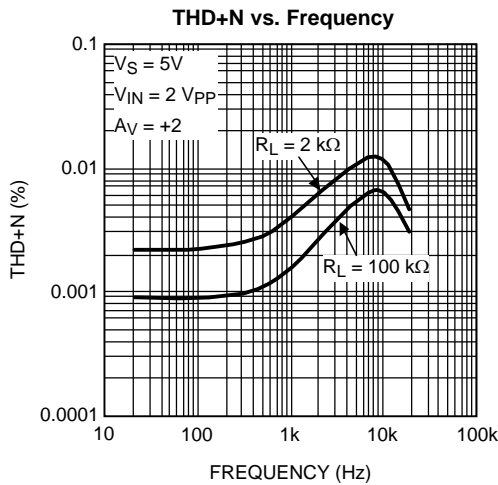

Figure 32.

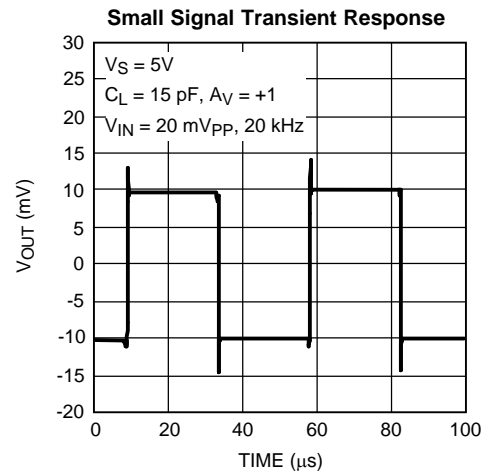

Figure 33.

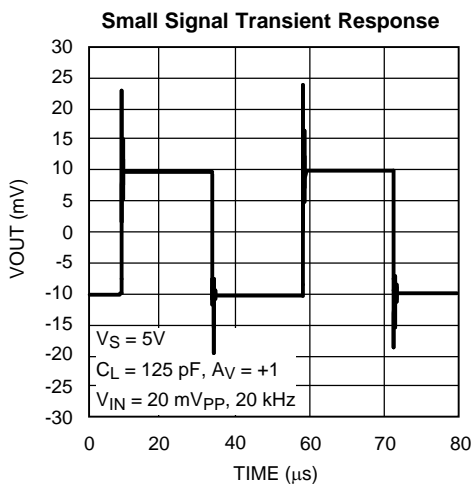

Figure 34.

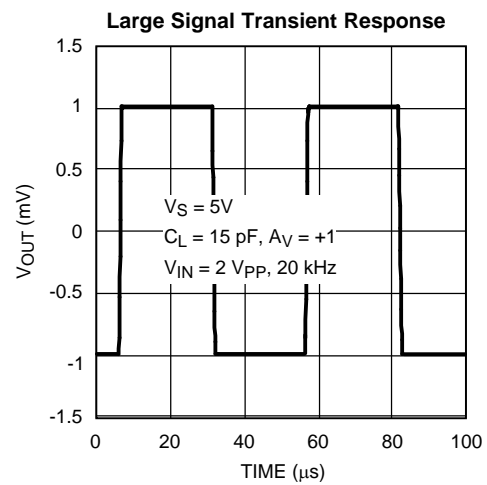

Figure 35.

Typical Performance Characteristics (continued)

Unless otherwise specified, $T_A = 25^\circ\text{C}$, $V_S = 5\text{V}$, $V^+ = 5\text{V}$, $V^- = 0\text{V}$, $V_{CM} = V_S/2$

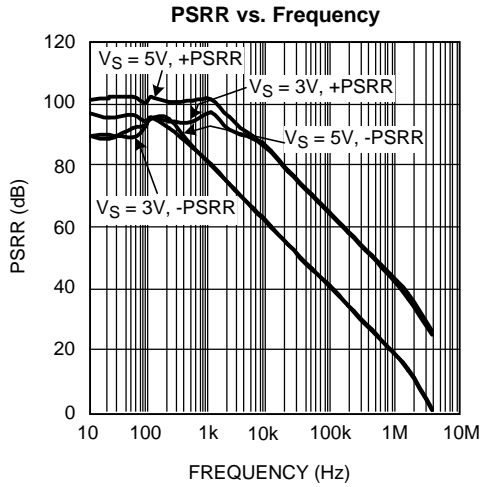

Figure 36.

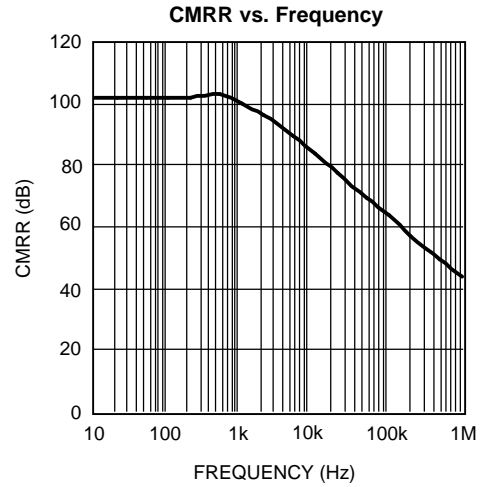

Figure 37.

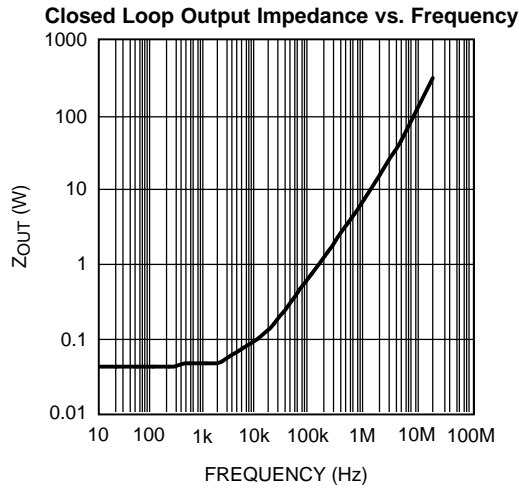

Figure 38.

APPLICATION INFORMATION

ADVANTAGES OF THE LMV651/LMV652/LMV654

Low Voltage and Low Power Operation

The LMV651/LMV652/LMV654 have performance specified at supply voltages of 3V and 5V. These parts are specified to be operational at all supply voltages between 2.7V and 5.5V. The LMV651 draws a low supply current of 116 μ A, the LMV652 draws 118 μ A/channel and the LMV654 draws 122 μ A/channel. This family of op amps provides the low voltage and low power amplification which is essential for portable applications.

Wide Bandwidth

Despite drawing the very low supply current of 116 μ A, the LMV651/LMV652/LMV654 manage to provide a wide unity gain bandwidth of 12 MHz. This is easily one of the best bandwidth to power ratios ever achieved, and allows these op amps to provide wideband amplification while using the minimum amount of power. This makes this family of parts ideal for low power signal processing applications such as portable media players and other accessories.

Low Input Referred Noise

The LMV651/LMV652/LMV654 provide a flatband input referred voltage noise density of 17 $\text{nV}/\sqrt{\text{Hz}}$, which is significantly better than the noise performance expected from a low power op amp. These op amps also feature exceptionally low 1/f noise, with a very low 1/f noise corner frequency of 4 Hz. This makes these parts ideal for low power applications which require decent noise performance, such as PDAs and portable sensors.

Ground Sensing and Rail-to-Rail Output

The LMV651/LMV652/LMV654 each have a rail-to-rail output stage, which provides the maximum possible output dynamic range. This is especially important for applications requiring a large output swing. The input common mode range of this family of devices includes the negative supply rail which allows direct sensing at ground in a single supply operation.

Small Size

The small footprint of the packages for the LMV651/LMV652/LMV654 saves space on printed circuit boards, and enables the design of smaller and more compact electronic products. Long traces between the signal source and the op amp make the signal path susceptible to noise. By using a physically smaller package, these op amps can be placed closer to the signal source, reducing noise pickup and enhancing signal integrity.

STABILITY OF OP AMP CIRCUITS

Stability and Capacitive Loading

If the phase margin of the LMV651/LMV652/LMV654 is plotted with respect to the capacitive load (C_L) at its output, it is seen that the phase margin reduces significantly if C_L is increased beyond 100 pF. This is because the op amp is designed to provide the maximum bandwidth possible for a low supply current. Stabilizing it for higher capacitive loads would have required either a drastic increase in supply current, or a large internal compensation capacitance, which would have reduced the bandwidth of the op amp. Hence, if these devices are to be used for driving higher capacitive loads, they would have to be externally compensated.

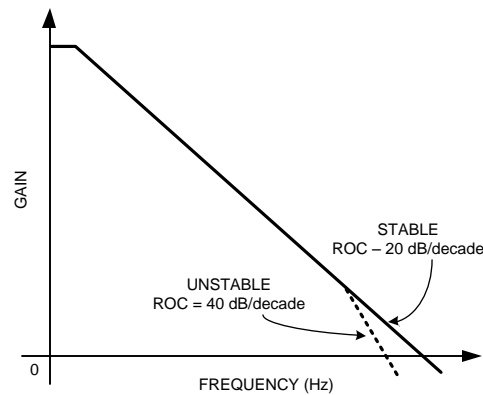

Figure 39. Gain vs. Frequency for an Op Amp

An op amp, ideally, has a dominant pole close to DC, which causes its gain to decay at the rate of 20 dB/decade with respect to frequency. If this rate of decay, also known as the rate of closure (ROC), remains the same until the op amp's unity gain bandwidth, the op amp is stable. If, however, a large capacitance is added to the output of the op amp, it combines with the output impedance of the op amp to create another pole in its frequency response before its unity gain frequency (Figure 39). This increases the ROC to 40 dB/decade and causes instability.

In such a case a number of techniques can be used to restore stability to the circuit. The idea behind all these schemes is to modify the frequency response such that it can be restored to an ROC of 20 dB/decade, which ensures stability.

In The Loop Compensation

Figure 40 illustrates a compensation technique, known as 'in the loop' compensation, that employs an RC feedback circuit within the feedback loop to stabilize a non-inverting amplifier configuration. A small series resistance, R_S , is used to isolate the amplifier output from the load capacitance, C_L , and a small capacitance, C_F , is inserted across the feedback resistor to bypass C_L at higher frequencies.

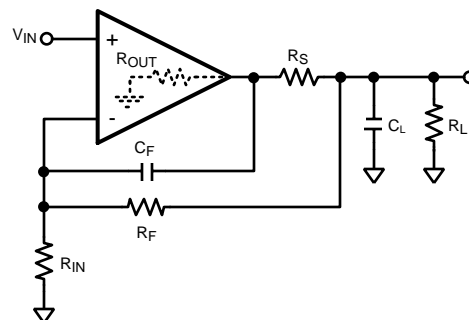

Figure 40. In the Loop Compensation

The values for R_S and C_F are decided by ensuring that the zero attributed to C_F lies at the same frequency as the pole attributed to C_L . This ensures that the effect of the second pole on the transfer function is compensated for by the presence of the zero, and that the ROC is maintained at 20 dB/decade. For the circuit shown in Figure 40 the values of R_S and C_F are given by Equation 1. Values of R_S and C_F required for maintaining stability for different values of C_L , as well as the phase margins obtained, are shown in Table 1. R_F and R_{IN} are taken to be 10 k Ω , R_L is 2 k Ω , while R_{OUT} is taken as 340 Ω .

$$R_S = \frac{R_{OUT}R_{IN}}{R_F}$$

$$C_F = \left(\frac{R_F + 2R_{IN}}{R_F^2} \right) C_L R_{OUT} \tag{1}$$

Table 1.

C _L (pF)	R _S (Ω)	C _F (pF)	Phase Margin (°)
150	340	15	39.4
200	340	20	34.6
250	340	25	31.1

Although this methodology provides circuit stability for any load capacitance, it does so at the price of bandwidth. The closed loop bandwidth of the circuit is now limited by R_F and C_F.

Compensation By External Resistor

In some applications it is essential to drive a capacitive load without sacrificing bandwidth. In such a case, in the loop compensation is not viable. A simpler scheme for compensation is shown in Figure 41. A resistor, R_{ISO}, is placed in series between the load capacitance and the output. This introduces a zero in the circuit transfer function, which counteracts the effect of the pole formed by the load capacitance, and ensures stability. The value of R_{ISO} to be used should be decided depending on the size of C_L and the level of performance desired. Values ranging from 5Ω to 50Ω are usually sufficient to ensure stability. A larger value of R_{ISO} will result in a system with lesser ringing and overshoot, but will also limit the output swing and the short circuit current of the circuit.

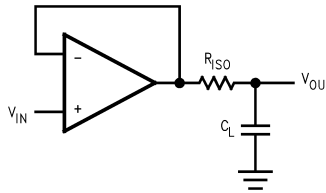

Figure 41. Compensation by Isolation Resistor

Typical Applications

HIGH GAIN LOW POWER AMPLIFIERS

With a low supply current, low power operation, and low harmonic distortion, the LMV651/LMV652/LMV654 are ideal for wide-bandwidth, high gain amplification. The wide unity gain bandwidth allows these parts to provide large gain over a wide frequency range, while driving loads as low as 2 kΩ with less than 0.003% distortion. Two amplifier circuits are shown in Figure 42 and Figure 43. Figure 42 is an inverting amplifier, with a 100 kΩ feedback resistor, R₂, and a 1 kΩ input resistor, R₁, and provides a gain of -100. With the LMV651/LMV652/LMV654 these circuits can provide gain of -100 with a -3 dB bandwidth of 120 kHz, for a quiescent current as low as 116 μA. Similarly, the circuit in Figure 43, a non-inverting amplifier with a gain of 1001, can provide that gain with a -3 dB bandwidth of 12 kHz, for a similar low quiescent power dissipation. Coupling capacitors C_{C1} and C_{C2} can be added to isolate the circuit from DC voltages, while R_{B1} and R_{B2} provide DC biasing. A feedback capacitor C_F can also be added to improve compensation.

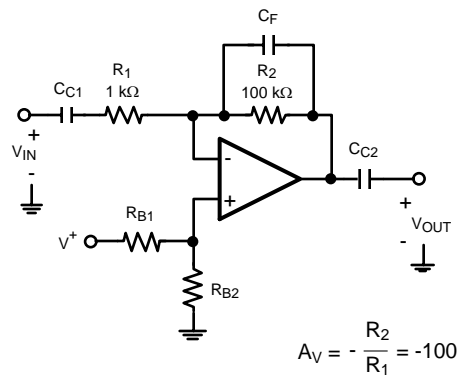

Figure 42. High Gain Inverting Amplifier

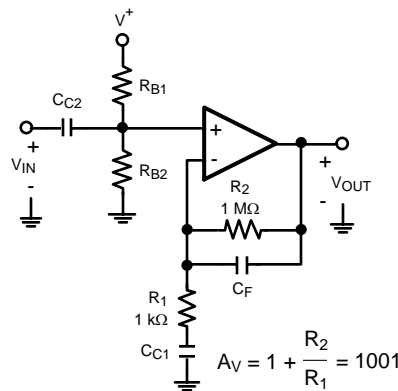

Figure 43. High Gain Non-Inverting Amplifier

ACTIVE FILTERS

With a wide unity gain bandwidth of 12 MHz, low input referred noise density and a low power supply current, the LMV651/LMV652/LMV654 are well suited for low-power filtering applications. Active filter topologies, like the Sallen-Key low pass filter shown in Figure 44, are very versatile, and can be used to design a wide variety of filters (Chebyshev, Butterworth or Bessel). The Sallen-Key topology, in particular, can be used to attain a wide range of Q, by using positive feedback to reject the undesired frequency range.

In the circuit shown in Figure 44, the two capacitors appear as open circuits at lower frequencies and the signal is simply buffered to the output. At high frequencies the capacitors appear as short circuits and the signal is shunted to ground by one of the capacitors before it can be amplified. Near the cut-off frequency, where the impedance of the capacitances is on the same order as R_g and R_f , positive feedback through the other capacitor allows the circuit to attain the desired Q. The ratio of the two resistors, m^2 , provides a knob to control the value of Q obtained.

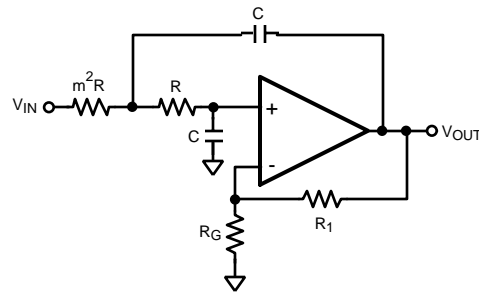

Figure 44. Sallen-Key Low Pass Filter

REVISION HISTORY

Changes from Revision I (March 2013) to Revision J	Page
<hr/> <ul style="list-style-type: none">• Changed layout of National Data Sheet to TI format	<hr/> 16

PACKAGING INFORMATION

Orderable Device	Status (1)	Package Type	Package Drawing	Pins	Package Qty	Eco Plan (2)	Lead/Ball Finish (6)	MSL Peak Temp (3)	Op Temp (°C)	Device Marking (4/5)	Samples
LMV651MF/NOPB	ACTIVE	SOT-23	DBV	5	1000	Green (RoHS & no Sb/Br)	CU SN	Level-1-260C-UNLIM		AY2A	Samples
LMV651MFX/NOPB	ACTIVE	SOT-23	DBV	5	3000	Green (RoHS & no Sb/Br)	CU SN	Level-1-260C-UNLIM		AY2A	Samples
LMV651MG/NOPB	ACTIVE	SC70	DCK	5	1000	Green (RoHS & no Sb/Br)	CU SN	Level-1-260C-UNLIM	-40 to 125	A93	Samples
LMV651MGX/NOPB	ACTIVE	SC70	DCK	5	3000	Green (RoHS & no Sb/Br)	CU SN	Level-1-260C-UNLIM	-40 to 125	A93	Samples
LMV652MM/NOPB	ACTIVE	VSSOP	DGK	8	1000	Green (RoHS & no Sb/Br)	CU SN	Level-1-260C-UNLIM	-40 to 125	AB3A	Samples
LMV652MMX/NOPB	ACTIVE	VSSOP	DGK	8	3500	Green (RoHS & no Sb/Br)	CU SN	Level-1-260C-UNLIM	-40 to 125	AB3A	Samples
LMV654MT/NOPB	ACTIVE	TSSOP	PW	14	94	Green (RoHS & no Sb/Br)	CU SN	Level-1-260C-UNLIM	-40 to 125	LMV65 4MT	Samples
LMV654MTX/NOPB	ACTIVE	TSSOP	PW	14	2500	Green (RoHS & no Sb/Br)	CU SN	Level-1-260C-UNLIM	-40 to 125	LMV65 4MT	Samples

(1) The marketing status values are defined as follows:

ACTIVE: Product device recommended for new designs.

LIFEBUY: TI has announced that the device will be discontinued, and a lifetime-buy period is in effect.

NRND: Not recommended for new designs. Device is in production to support existing customers, but TI does not recommend using this part in a new design.

PREVIEW: Device has been announced but is not in production. Samples may or may not be available.

OBSOLETE: TI has discontinued the production of the device.

(2) Eco Plan - The planned eco-friendly classification: Pb-Free (RoHS), Pb-Free (RoHS Exempt), or Green (RoHS & no Sb/Br) - please check <http://www.ti.com/productcontent> for the latest availability information and additional product content details.

TBD: The Pb-Free/Green conversion plan has not been defined.

Pb-Free (RoHS): TI's terms "Lead-Free" or "Pb-Free" mean semiconductor products that are compatible with the current RoHS requirements for all 6 substances, including the requirement that lead not exceed 0.1% by weight in homogeneous materials. Where designed to be soldered at high temperatures, TI Pb-Free products are suitable for use in specified lead-free processes.

Pb-Free (RoHS Exempt): This component has a RoHS exemption for either 1) lead-based flip-chip solder bumps used between the die and package, or 2) lead-based die adhesive used between the die and leadframe. The component is otherwise considered Pb-Free (RoHS compatible) as defined above.

Green (RoHS & no Sb/Br): TI defines "Green" to mean Pb-Free (RoHS compatible), and free of Bromine (Br) and Antimony (Sb) based flame retardants (Br or Sb do not exceed 0.1% by weight in homogeneous material)

(3) MSL, Peak Temp. - The Moisture Sensitivity Level rating according to the JEDEC industry standard classifications, and peak solder temperature.

(4) There may be additional marking, which relates to the logo, the lot trace code information, or the environmental category on the device.

(5) Multiple Device Markings will be inside parentheses. Only one Device Marking contained in parentheses and separated by a "~" will appear on a device. If a line is indented then it is a continuation of the previous line and the two combined represent the entire Device Marking for that device.

(6) Lead/Ball Finish - Orderable Devices may have multiple material finish options. Finish options are separated by a vertical ruled line. Lead/Ball Finish values may wrap to two lines if the finish value exceeds the maximum column width.

Important Information and Disclaimer:The information provided on this page represents TI's knowledge and belief as of the date that it is provided. TI bases its knowledge and belief on information provided by third parties, and makes no representation or warranty as to the accuracy of such information. Efforts are underway to better integrate information from third parties. TI has taken and continues to take reasonable steps to provide representative and accurate information but may not have conducted destructive testing or chemical analysis on incoming materials and chemicals. TI and TI suppliers consider certain information to be proprietary, and thus CAS numbers and other limited information may not be available for release.

In no event shall TI's liability arising out of such information exceed the total purchase price of the TI part(s) at issue in this document sold by TI to Customer on an annual basis.

TAPE AND REEL INFORMATION

QUADRANT ASSIGNMENTS FOR PIN 1 ORIENTATION IN TAPE

*All dimensions are nominal

Device	Package Type	Package Drawing	Pins	SPQ	Reel Diameter (mm)	Reel Width W1 (mm)	A0 (mm)	B0 (mm)	K0 (mm)	P1 (mm)	W (mm)	Pin1 Quadrant
LMV651MF/NOPB	SOT-23	DBV	5	1000	178.0	8.4	3.2	3.2	1.4	4.0	8.0	Q3
LMV651MFX/NOPB	SOT-23	DBV	5	3000	178.0	8.4	3.2	3.2	1.4	4.0	8.0	Q3
LMV651MG/NOPB	SC70	DCK	5	1000	178.0	8.4	2.25	2.45	1.2	4.0	8.0	Q3
LMV651MGX/NOPB	SC70	DCK	5	3000	178.0	8.4	2.25	2.45	1.2	4.0	8.0	Q3
LMV652MM/NOPB	VSSOP	DGK	8	1000	178.0	12.4	5.3	3.4	1.4	8.0	12.0	Q1
LMV652MMX/NOPB	VSSOP	DGK	8	3500	330.0	12.4	5.3	3.4	1.4	8.0	12.0	Q1
LMV654MTX/NOPB	TSSOP	PW	14	2500	330.0	12.4	6.95	8.3	1.6	8.0	12.0	Q1

TAPE AND REEL BOX DIMENSIONS

*All dimensions are nominal

Device	Package Type	Package Drawing	Pins	SPQ	Length (mm)	Width (mm)	Height (mm)
LMV651MF/NOPB	SOT-23	DBV	5	1000	210.0	185.0	35.0
LMV651MFX/NOPB	SOT-23	DBV	5	3000	210.0	185.0	35.0
LMV651MG/NOPB	SC70	DCK	5	1000	210.0	185.0	35.0
LMV651MGX/NOPB	SC70	DCK	5	3000	210.0	185.0	35.0
LMV652MM/NOPB	VSSOP	DGK	8	1000	210.0	185.0	35.0
LMV652MMX/NOPB	VSSOP	DGK	8	3500	367.0	367.0	35.0
LMV654MTX/NOPB	TSSOP	PW	14	2500	367.0	367.0	35.0

DBV (R-PDSO-G5)

PLASTIC SMALL OUTLINE

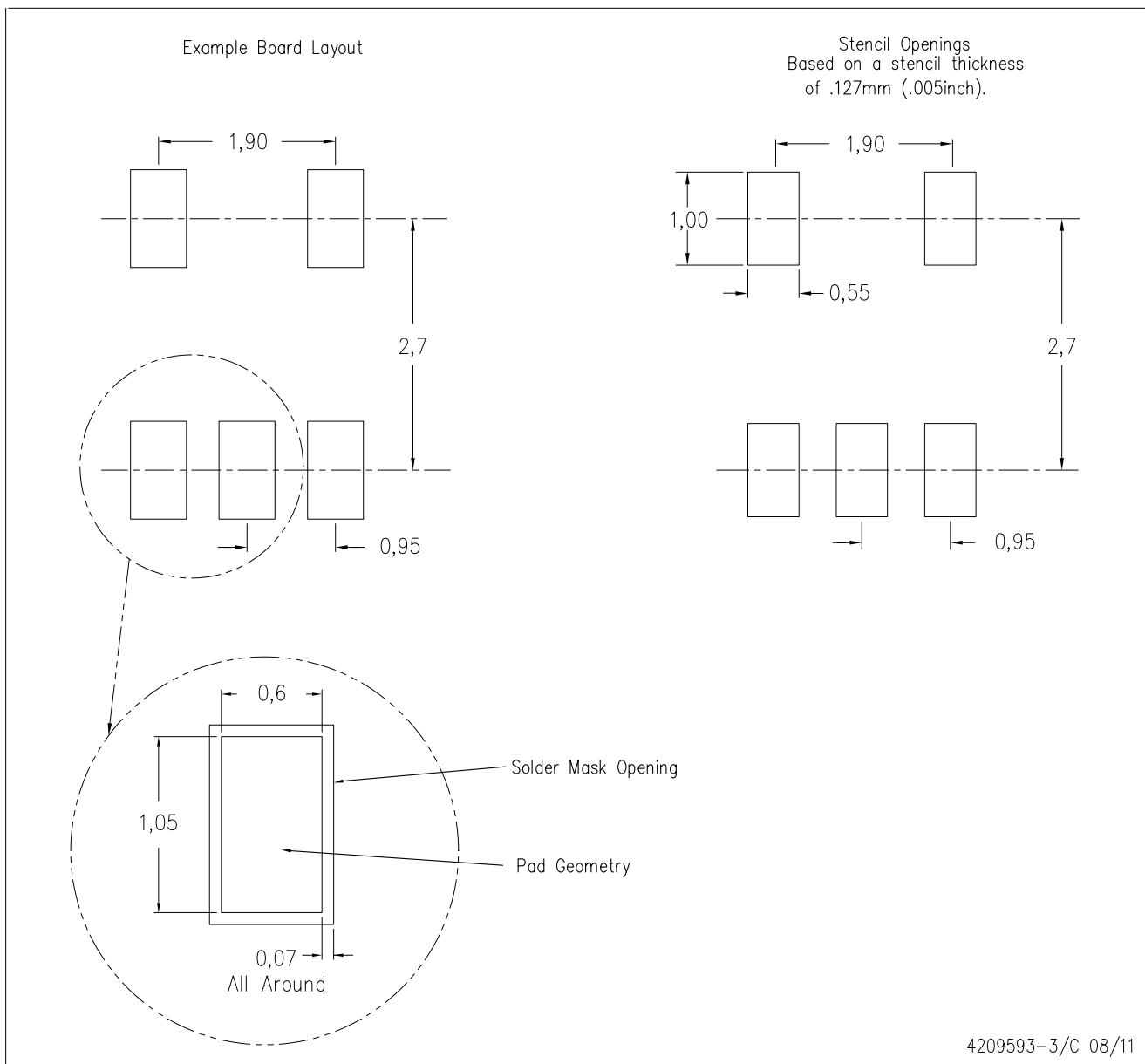

- NOTES:
- A. All linear dimensions are in millimeters.
 - B. This drawing is subject to change without notice.
 - C. Customers should place a note on the circuit board fabrication drawing not to alter the center solder mask defined pad.
 - D. Publication IPC-7351 is recommended for alternate designs.
 - E. Laser cutting apertures with trapezoidal walls and also rounding corners will offer better paste release. Customers should contact their board assembly site for stencil design recommendations. Example stencil design based on a 50% volumetric metal load solder paste. Refer to IPC-7525 for other stencil recommendations.

DCK (R-PDSO-G5)

PLASTIC SMALL-OUTLINE PACKAGE

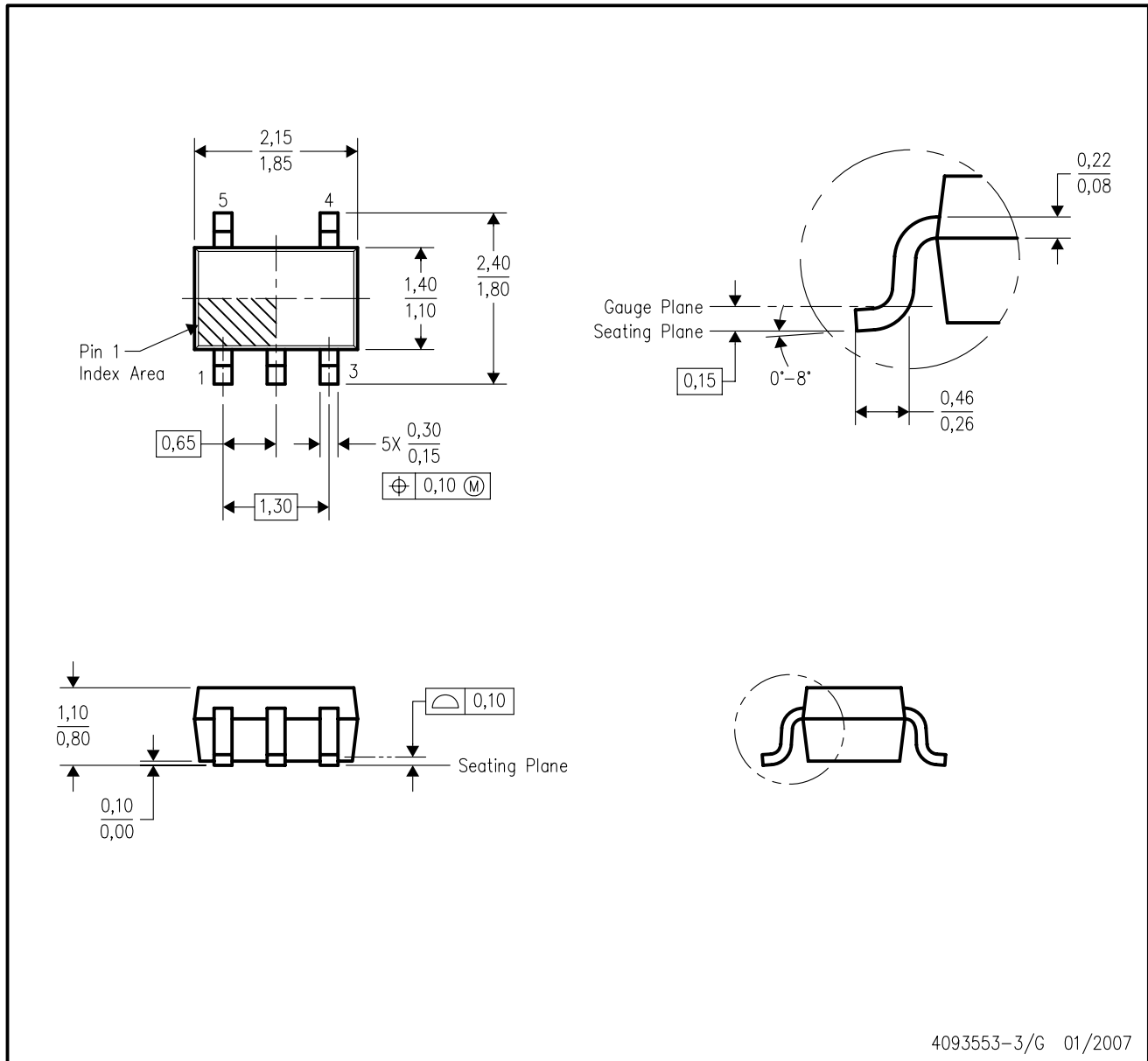

- NOTES:
- A. All linear dimensions are in millimeters.
 - B. This drawing is subject to change without notice.
 - C. Body dimensions do not include mold flash or protrusion. Mold flash and protrusion shall not exceed 0.15 per side.
 - D. Falls within JEDEC MO-203 variation AA.

DCK (R-PDSO-G5)

PLASTIC SMALL OUTLINE

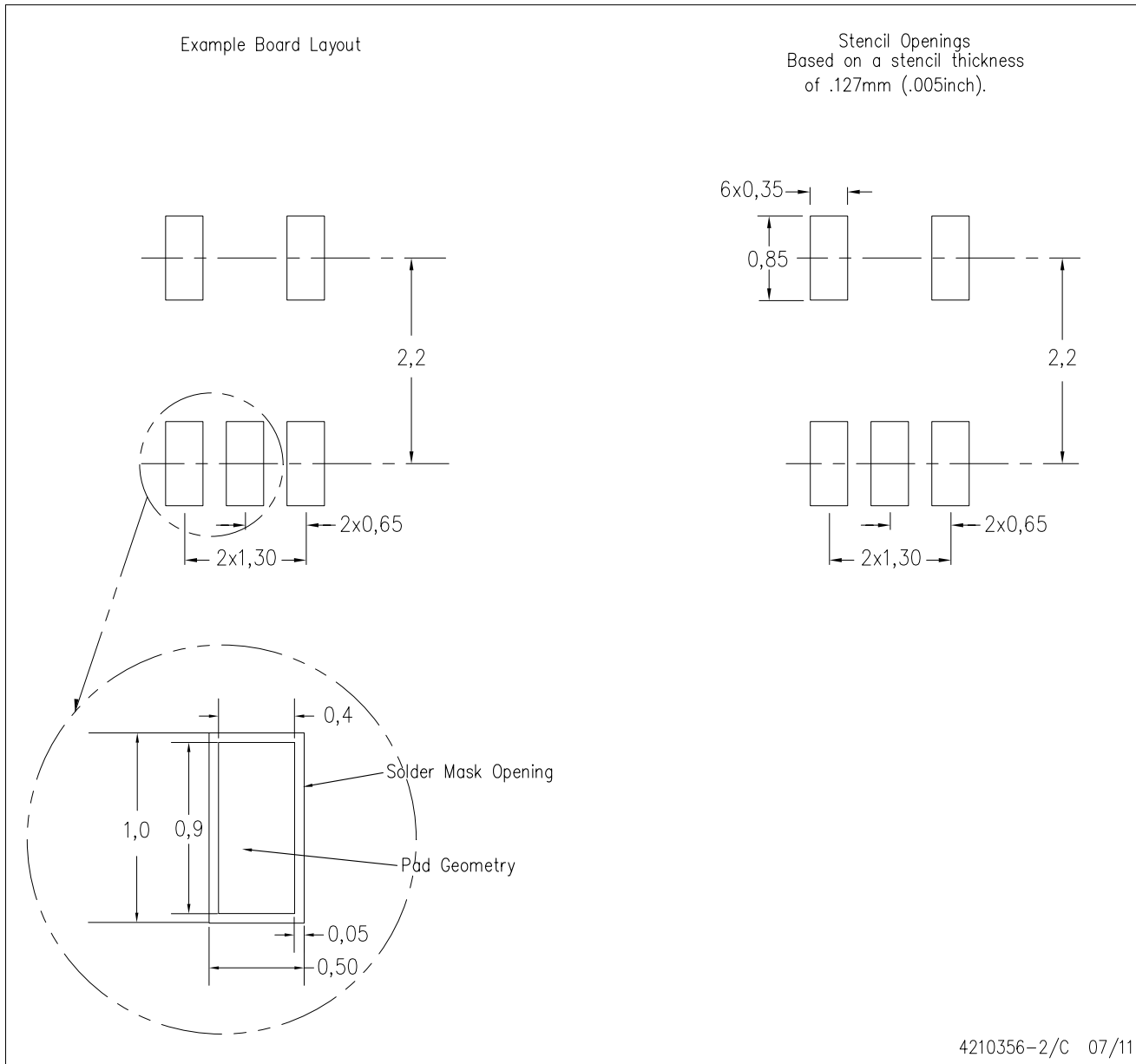

- NOTES:
- All linear dimensions are in millimeters.
 - This drawing is subject to change without notice.
 - Customers should place a note on the circuit board fabrication drawing not to alter the center solder mask defined pad.
 - Publication IPC-7351 is recommended for alternate designs.
 - Laser cutting apertures with trapezoidal walls and also rounding corners will offer better paste release. Customers should contact their board assembly site for stencil design recommendations. Example stencil design based on a 50% volumetric metal load solder paste. Refer to IPC-7525 for other stencil recommendations.

DGK (S-PDSO-G8)

PLASTIC SMALL-OUTLINE PACKAGE



- NOTES:
- A. All linear dimensions are in millimeters.
 - B. This drawing is subject to change without notice.
 - C. Body length does not include mold flash, protrusions, or gate burrs. Mold flash, protrusions, or gate burrs shall not exceed 0.15 per end.
 - D. Body width does not include interlead flash. Interlead flash shall not exceed 0.50 per side.
 - E. Falls within JEDEC MO-187 variation AA, except interlead flash.

PW (R-PDSO-G14)

PLASTIC SMALL OUTLINE



- NOTES:
- A. All linear dimensions are in millimeters. Dimensioning and tolerancing per ASME Y14.5M-1994.
 - B. This drawing is subject to change without notice.
 - C. Body length does not include mold flash, protrusions, or gate burrs. Mold flash, protrusions, or gate burrs shall not exceed 0,15 each side.
 - D. Body width does not include interlead flash. Interlead flash shall not exceed 0,25 each side.
 - E. Falls within JEDEC MO-153

IMPORTANT NOTICE

Texas Instruments Incorporated and its subsidiaries (TI) reserve the right to make corrections, enhancements, improvements and other changes to its semiconductor products and services per JESD46, latest issue, and to discontinue any product or service per JESD48, latest issue. Buyers should obtain the latest relevant information before placing orders and should verify that such information is current and complete. All semiconductor products (also referred to herein as "components") are sold subject to TI's terms and conditions of sale supplied at the time of order acknowledgment.

TI warrants performance of its components to the specifications applicable at the time of sale, in accordance with the warranty in TI's terms and conditions of sale of semiconductor products. Testing and other quality control techniques are used to the extent TI deems necessary to support this warranty. Except where mandated by applicable law, testing of all parameters of each component is not necessarily performed.

TI assumes no liability for applications assistance or the design of Buyers' products. Buyers are responsible for their products and applications using TI components. To minimize the risks associated with Buyers' products and applications, Buyers should provide adequate design and operating safeguards.

TI does not warrant or represent that any license, either express or implied, is granted under any patent right, copyright, mask work right, or other intellectual property right relating to any combination, machine, or process in which TI components or services are used. Information published by TI regarding third-party products or services does not constitute a license to use such products or services or a warranty or endorsement thereof. Use of such information may require a license from a third party under the patents or other intellectual property of the third party, or a license from TI under the patents or other intellectual property of TI.

Reproduction of significant portions of TI information in TI data books or data sheets is permissible only if reproduction is without alteration and is accompanied by all associated warranties, conditions, limitations, and notices. TI is not responsible or liable for such altered documentation. Information of third parties may be subject to additional restrictions.

Resale of TI components or services with statements different from or beyond the parameters stated by TI for that component or service voids all express and any implied warranties for the associated TI component or service and is an unfair and deceptive business practice. TI is not responsible or liable for any such statements.

Buyer acknowledges and agrees that it is solely responsible for compliance with all legal, regulatory and safety-related requirements concerning its products, and any use of TI components in its applications, notwithstanding any applications-related information or support that may be provided by TI. Buyer represents and agrees that it has all the necessary expertise to create and implement safeguards which anticipate dangerous consequences of failures, monitor failures and their consequences, lessen the likelihood of failures that might cause harm and take appropriate remedial actions. Buyer will fully indemnify TI and its representatives against any damages arising out of the use of any TI components in safety-critical applications.

In some cases, TI components may be promoted specifically to facilitate safety-related applications. With such components, TI's goal is to help enable customers to design and create their own end-product solutions that meet applicable functional safety standards and requirements. Nonetheless, such components are subject to these terms.

No TI components are authorized for use in FDA Class III (or similar life-critical medical equipment) unless authorized officers of the parties have executed a special agreement specifically governing such use.

Only those TI components which TI has specifically designated as military grade or "enhanced plastic" are designed and intended for use in military/aerospace applications or environments. Buyer acknowledges and agrees that any military or aerospace use of TI components which have **not** been so designated is solely at the Buyer's risk, and that Buyer is solely responsible for compliance with all legal and regulatory requirements in connection with such use.

TI has specifically designated certain components as meeting ISO/TS16949 requirements, mainly for automotive use. In any case of use of non-designated products, TI will not be responsible for any failure to meet ISO/TS16949.

Products

Audio	www.ti.com/audio
Amplifiers	amplifier.ti.com
Data Converters	dataconverter.ti.com
DLP® Products	www.dlp.com
DSP	dsp.ti.com
Clocks and Timers	www.ti.com/clocks
Interface	interface.ti.com
Logic	logic.ti.com
Power Mgmt	power.ti.com
Microcontrollers	microcontroller.ti.com
RFID	www.ti-rfid.com
OMAP Applications Processors	www.ti.com/omap
Wireless Connectivity	www.ti.com/wirelessconnectivity

Applications

Automotive and Transportation	www.ti.com/automotive
Communications and Telecom	www.ti.com/communications
Computers and Peripherals	www.ti.com/computers
Consumer Electronics	www.ti.com/consumer-apps
Energy and Lighting	www.ti.com/energy
Industrial	www.ti.com/industrial
Medical	www.ti.com/medical
Security	www.ti.com/security
Space, Avionics and Defense	www.ti.com/space-avionics-defense
Video and Imaging	www.ti.com/video

TI E2E Community

e2e.ti.com