



Is Now Part of



ON Semiconductor®

To learn more about ON Semiconductor, please visit our website at www.onsemi.com

Please note: As part of the Fairchild Semiconductor integration, some of the Fairchild orderable part numbers will need to change in order to meet ON Semiconductor's system requirements. Since the ON Semiconductor product management systems do not have the ability to manage part nomenclature that utilizes an underscore (), the underscore () in the Fairchild part numbers will be changed to a dash (-). This document may contain device numbers with an underscore (). Please check the ON Semiconductor website to verify the updated device numbers. The most current and up-to-date ordering information can be found at www.onsemi.com. Please email any questions regarding the system integration to Fairchild_questions@onsemi.com.

ON Semiconductor and the ON Semiconductor logo are trademarks of Semiconductor Components Industries, LLC dba ON Semiconductor or its subsidiaries in the United States and/or other countries. ON Semiconductor owns the rights to a number of patents, trademarks, copyrights, trade secrets, and other intellectual property. A listing of ON Semiconductor's product/patent coverage may be accessed at www.onsemi.com/site/pdf/Patent-Marking.pdf. ON Semiconductor reserves the right to make changes without further notice to any products herein. ON Semiconductor makes no warranty, representation or guarantee regarding the suitability of its products for any particular purpose, nor does ON Semiconductor assume any liability arising out of the application or use of any product or circuit, and specifically disclaims any and all liability, including without limitation special, consequential or incidental damages. Buyer is responsible for its products and applications using ON Semiconductor products, including compliance with all laws, regulations and safety requirements or standards, regardless of any support or applications information provided by ON Semiconductor. "Typical" parameters which may be provided in ON Semiconductor data sheets and/or specifications can and do vary in different applications and actual performance may vary over time. All operating parameters, including "Typicals" must be validated for each customer application by customer's technical experts. ON Semiconductor does not convey any license under its patent rights nor the rights of others. ON Semiconductor products are not designed, intended, or authorized for use as a critical component in life support systems or any FDA Class 3 medical devices or medical devices with a same or similar classification in a foreign jurisdiction or any devices intended for implantation in the human body. Should Buyer purchase or use ON Semiconductor products for any such unintended or unauthorized application, Buyer shall indemnify and hold ON Semiconductor and its officers, employees, subsidiaries, affiliates, and distributors harmless against all claims, costs, damages, and expenses, and reasonable attorney fees arising out of, directly or indirectly, any claim of personal injury or death associated with such unintended or unauthorized use, even if such claim alleges that ON Semiconductor was negligent regarding the design or manufacture of the part. ON Semiconductor is an Equal Opportunity/Affirmative Action Employer. This literature is subject to all applicable copyright laws and is not for resale in any manner.

LM2903, LM393/LM393A, LM293A

Dual Differential Comparator

Features

- Single Supply Operation: 2V to 36V
- Dual Supply Operation: $\pm 1\text{V}$ to $\pm 18\text{V}$
- Allow Comparison of Voltages Near Ground Potential
- Low Current Drain $800\mu\text{A}$ Typ.
- Compatible with all Forms of Logic
- Low Input Bias Current 25nA Typ.
- Low Input Offset Current $\pm 5\text{nA}$ Typ.
- Low Offset Voltage $\pm 1\text{mV}$ Typ.

Description

The LM2903, LM393/LM393A, LM293A consist of two independent voltage comparators designed to operate from a single power supply over a wide voltage range.

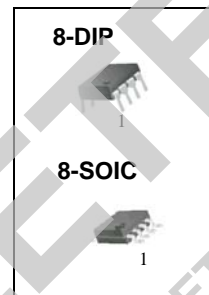

Internal Block Diagram

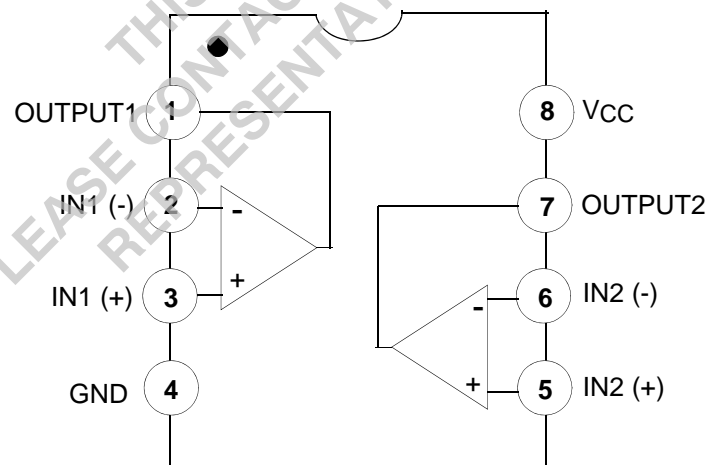

Schematic Diagram

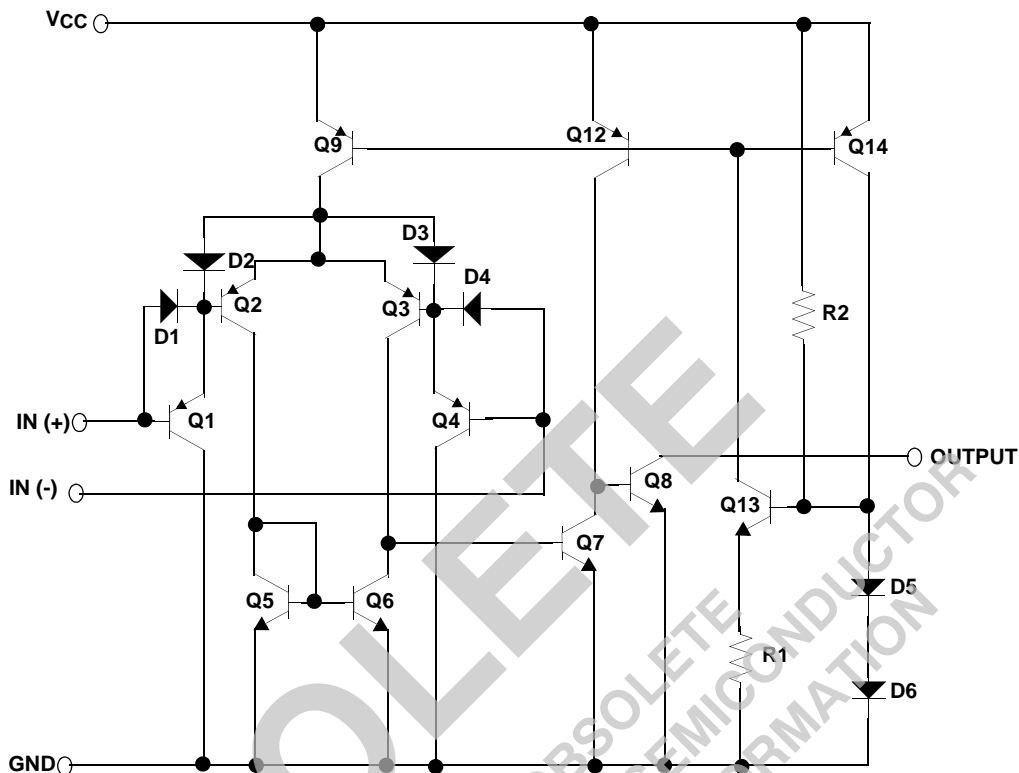

Absolute Maximum Ratings

Parameter	Symbol	Value	Unit
Power Supply Voltage	VCC	±18 or 36	V
Differential Input Voltage	VI(DIFF)	36	V
Input Voltage	VI	-0.3 to +36	V
Output Short Circuit to GND		Continuous	-
Power Dissipation, Ta = 25°C	PD	1040 480	mW
Operating Temperature	TOPR	0 ~ +70 -40 ~ +105 -25 ~ +85	°C
Storage Temperature	TSTG	-65 ~ +150	°C

Thermal Data

Parameter	Symbol	Value	Unit
Thermal Resistance Junction-Ambient Max.	Rθja	120 260	°C/W

Electrical Characteristics

($V_{CC} = 5V$, $T_A = 25^\circ C$, unless otherwise specified)

Parameter	Symbol	Conditions	LM293A/LM393A			LM393			Unit
			Min.	Typ.	Max.	Min.	Typ.	Max.	
Input Offset Voltage	V_{IO}	$V_{O(P)} = 1.4V$, $R_S = 0\Omega$	-	± 1	± 2	-	± 1	± 5	mV
		$V_{CM} = 0$ to $1.5V$ Note1	-	-	± 4.0	-	-	± 9.0	
Input Offset Current	I_{IO}		-	± 5	± 50	-	± 5	± 50	nA
		Note1	-	-	± 150	-	-	± 150	
Input Bias Current	I_{BIAS}		-	65	250	-	65	250	nA
		Note1	-	-	400	-	-	400	
Input Common Mode Voltage Range	$V_{I(R)}$		0	-	$V_{CC} - 1.5$	0	-	$V_{CC} - 1.5$	V
		Note1	0	-	$V_{CC} - 2$	0	-	$V_{CC} - 2$	
Supply Current	I_{CC}	$R_L = \infty$, $V_{CC} = 5V$	-	0.6	1	-	0.6	1	mA
		$R_L = \infty$, $V_{CC} = 30V$	-	0.8	2.5	-	0.8	2.5	
Voltage Gain	G_V	$V_{CC} = 15V$, $R_L \geq 15k\Omega$ (for large $V_{O(P-P)}$ swing)	50	200	-	50	200	-	V/mV
Large Signal Response Time	T_{LRES}	$V_I = \text{TTL Logic Swing}$ $V_{REF} = 1.4V$, $V_{RL} = 5V$, $R_L = 5.1k\Omega$	-	350	-	-	350	-	nS
Response Time	T_{RES}	$V_{RL} = 5V$, $R_L = 5.1k\Omega$	-	1.4	-	-	1.4	-	μS
Output Sink Current	I_{SINK}	$V_{I(-)} \geq 1V$, $V_{I(+)} = 0V$, $V_{O(P)} \leq 1.5V$	6	18	-	6	18	-	mA
Output Saturation Voltage	V_{SAT}	$V_{I(-)} \geq 1V$, $V_{I(+)} = 0V$	-	160	400	-	160	400	mV
		$I_{SINK} = 4mA$ Note1	-	-	700	-	-	700	
Output Leakage Current	$I_{O(LKG)}$	$V_{I(-)} = 0V$, $V_{I(+)} = 1V$	-	0.1	-	-	0.1	-	nA
		$V_{O(P)} = 5V$ $V_{O(P)} = 30V$	-	-	1.0	-	-	1.0	μA

Note1

LM393/LM393A: $0 \leq T_A \leq +70^\circ C$

LM2903: $-40 \leq T_A \leq +105^\circ C$

LM293A: $-25 \leq T_A \leq +85^\circ C$

Electrical Characteristics (Continued)(V_{CC} = 5V, T_A = 25°C, unless otherwise specified)

Parameter	Symbol	Conditions	LM2903			Unit
			Min.	Typ.	Max.	
Input Offset Voltage	V _{IO}	V _{O(P)} = 1.4V, R _S = 0Ω	-	±1	±7	mV
		V _{CM} = 0 to 1.5V Note1	-	±9	±15	
Input Offset Current	I _{IO}		-	±5	±50	nA
		Note1	-	±50	±200	
Input Bias Current	I _{BIAS}		-	65	250	nA
		Note1	-	-	500	
Input Common Mode Voltage Range	V _{I(R)}		0	-	V _{CC} - 1.5	V
		Note1	0	-	V _{CC} - 2	
Supply Current	I _{CC}	R _L = ∞, V _{CC} = 5V	-	0.6	1	mA
		R _L = ∞, V _{CC} = 30V	-	1	2.5	
Voltage Gain	GV	V _{CC} = 15V, R _L ≥ 15kΩ (for large V _{O(P-P)} swing)	25	100	-	V/mV
Large Signal Response Time	T _{LR}	V _I = TTL Logic Swing V _{REF} = 1.4V, V _R = 5V, R _L = 5.1kΩ	-	350	-	nS
Response Time	T _{RES}	V _R = 5V, R _L = 5.1kΩ	-	1.5	-	μS
Output Sink Current	I _{SINK}	V _{I(-)} ≥ 1V, V _{I(+)} = 0V, V _{O(P)} ≤ 1.5V	6	16	-	mA
Output Saturation Voltage	V _{SAT}	V _{I(-)} ≥ 1V, V _{I(+)} = 0V	-	160	400	mV
		I _{SINK} = 4mA Note1	-	-	700	
Output Leakage Current	I _{O(LKG)}	V _{I(-)} = 0V, V _{O(P)} = 5V	-	0.1	-	nA
		V _{I(+)} = 1V, V _{O(P)} = 30V	-	-	1.0	μA

Note1LM393/LM393A: 0 ≤ T_A ≤ +70°CLM2903: -40 ≤ T_A ≤ +105°CLM293A : -25 ≤ T_A ≤ +85°C

Typical Performance Characteristics

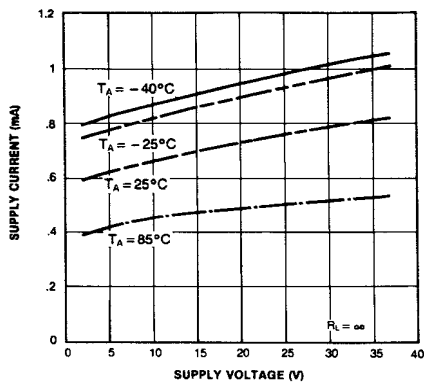

Figure 1. Supply Current vs Supply Voltage

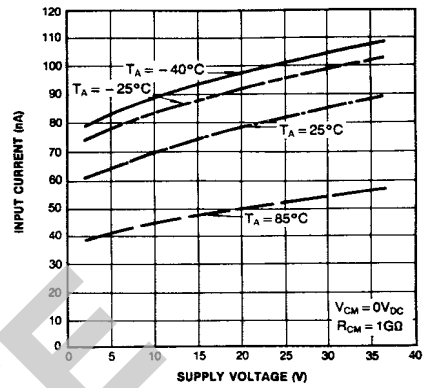

Figure 2. Input Current vs Supply Voltage

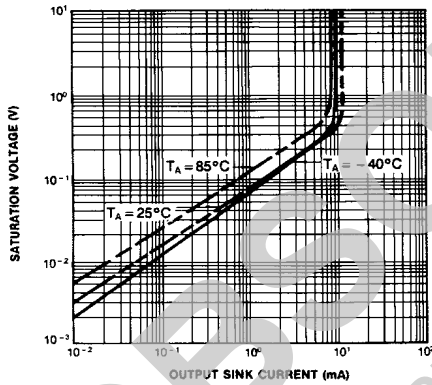

Figure 3. Output Saturation Voltage vs Sink Current

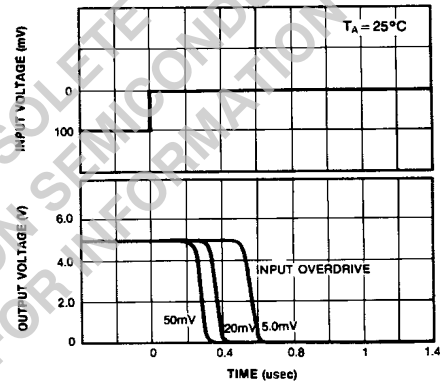

Figure 4. Response Time for Various Input Overdrive-Negative Transition

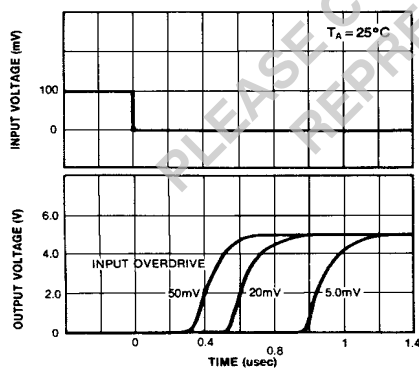

Figure 5. Response Time for Various Input Overdrive-Positive Transition

Mechanical Dimensions

Package

Dimensions in millimeters

8-DIP

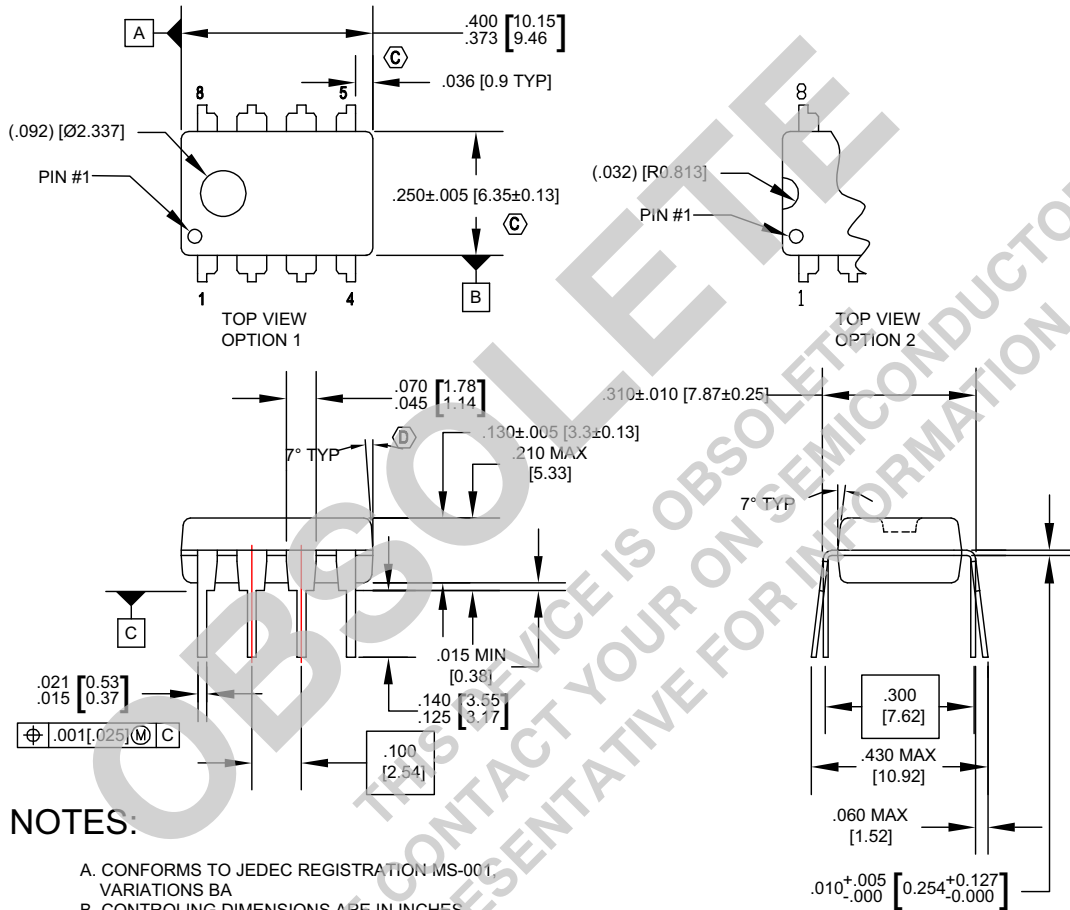

NOTES:

- A. CONFORMS TO JEDEC REGISTRATION MS-001 VARIATIONS BA
- B. CONTROLLING DIMENSIONS ARE IN INCHES REFERENCE DIMENSIONS ARE IN MILLIMETERS
- C. DOES NOT INCLUDE MOLD FLASH OR PROTRUSIONS. MOLD FLASH OR PROTRUSIONS SHALL NOT EXCEED .010 INCHES OR 0.25MM.
- D. DOES NOT INCLUDE DAMBAR PROTRUSIONS. DAMBAR PROTRUSIONS SHALL NOT EXCEED .010 INCHES OR 0.25MM.
- E. DIMENSIONING AND TOLERANCING PER ASME Y14.5M-1994.

N08EREVG

Ordering Information

Product Number	Operating Temperature	Package	Packing Method
LM393N	0 ~ +70°C	8-DIP	Rail
LM393AN			Rail
LM393M		8-SOIC	Rail
LM393MX			Tape & Reel
LM393AM			Rail
LM393AMX			Tape & Reel
LM2903N	-40 ~ +105°C	8-DIP	Rail
LM2903M		8-SOIC	Rail
LM2903MX			Tape & Reel
LM293AN	-25 ~ +85°C	8-DIP	Rail

DISCLAIMER

FAIRCHILD SEMICONDUCTOR RESERVES THE RIGHT TO MAKE CHANGES WITHOUT FURTHER NOTICE TO ANY PRODUCTS HEREIN TO IMPROVE RELIABILITY, FUNCTION OR DESIGN. FAIRCHILD DOES NOT ASSUME ANY LIABILITY ARISING OUT OF THE APPLICATION OR USE OF ANY PRODUCT OR CIRCUIT DESCRIBED HEREIN; NEITHER DOES IT CONVEY ANY LICENSE UNDER ITS PATENT RIGHTS, NOR THE RIGHTS OF OTHERS.

LIFE SUPPORT POLICY

FAIRCHILD'S PRODUCTS ARE NOT AUTHORIZED FOR USE AS CRITICAL COMPONENTS IN LIFE SUPPORT DEVICES OR SYSTEMS WITHOUT THE EXPRESS WRITTEN APPROVAL OF THE PRESIDENT OF FAIRCHILD SEMICONDUCTOR CORPORATION. As used herein:

1. Life support devices or systems are devices or systems which, (a) are intended for surgical implant into the body, or (b) support or sustain life, and (c) whose failure to perform when properly used in accordance with instructions for use provided in the labeling, can be reasonably expected to result in a significant injury of the user.
2. A critical component in any component of a life support device or system whose failure to perform can be reasonably expected to cause the failure of the life support device or system, or to affect its safety or effectiveness.

OBSOLETE
THIS DEVICE IS OBSOLETE
PLEASE CONTACT YOUR ON SEMICONDUCTOR
REPRESENTATIVE FOR INFORMATION

ON Semiconductor and  are trademarks of Semiconductor Components Industries, LLC dba ON Semiconductor or its subsidiaries in the United States and/or other countries. ON Semiconductor owns the rights to a number of patents, trademarks, copyrights, trade secrets, and other intellectual property. A listing of ON Semiconductor's product/patent coverage may be accessed at www.onsemi.com/site/pdf/Patent-Marking.pdf. ON Semiconductor reserves the right to make changes without further notice to any products herein. ON Semiconductor makes no warranty, representation or guarantee regarding the suitability of its products for any particular purpose, nor does ON Semiconductor assume any liability arising out of the application or use of any product or circuit, and specifically disclaims any and all liability, including without limitation special, consequential or incidental damages. Buyer is responsible for its products and applications using ON Semiconductor products, including compliance with all laws, regulations and safety requirements or standards, regardless of any support or applications information provided by ON Semiconductor. "Typical" parameters which may be provided in ON Semiconductor data sheets and/or specifications can and do vary in different applications and actual performance may vary over time. All operating parameters, including "Typicals" must be validated for each customer application by customer's technical experts. ON Semiconductor does not convey any license under its patent rights nor the rights of others. ON Semiconductor products are not designed, intended, or authorized for use as a critical component in life support systems or any FDA Class 3 medical devices or medical devices with a same or similar classification in a foreign jurisdiction or any devices intended for implantation in the human body. Should Buyer purchase or use ON Semiconductor products for any such unintended or unauthorized application, Buyer shall indemnify and hold ON Semiconductor and its officers, employees, subsidiaries, affiliates, and distributors harmless against all claims, costs, damages, and expenses, and reasonable attorney fees arising out of, directly or indirectly, any claim of personal injury or death associated with such unintended or unauthorized use, even if such claim alleges that ON Semiconductor was negligent regarding the design or manufacture of the part. ON Semiconductor is an Equal Opportunity/Affirmative Action Employer. This literature is subject to all applicable copyright laws and is not for resale in any manner.

PUBLICATION ORDERING INFORMATION

LITERATURE FULFILLMENT:

Literature Distribution Center for ON Semiconductor
19521 E. 32nd Pkwy, Aurora, Colorado 80011 USA
Phone: 303-675-2175 or 800-344-3860 Toll Free USA/Canada
Fax: 303-675-2176 or 800-344-3867 Toll Free USA/Canada
Email: orderlit@onsemi.com

N. American Technical Support: 800-282-9855 Toll Free
USA/Canada
Europe, Middle East and Africa Technical Support:
Phone: 421 33 790 2910
Japan Customer Focus Center
Phone: 81-3-5817-1050

ON Semiconductor Website: www.onsemi.com
Order Literature: <http://www.onsemi.com/orderlit>
For additional information, please contact your local
Sales Representative