

LE RTDUW S2W

OSRAM OSTAR® Stage

Compact lightsource in SMT technology, glass window on top, RoHS compliant

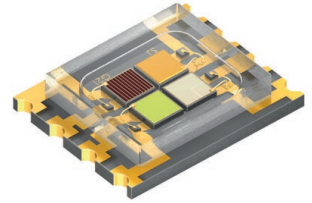

Applications

- Architecture
- Mood Lighting
- Stage Lighting (LED & Laser)

Features:

- Package: compact lightsource in multi chip SMT technology with glass window on top
- Chip technology: Thinfilm / ThinGaN
- Typ. Radiation: 120° (Lambertian emitter)
- Color: $\lambda_{\text{dom}} = 625 \text{ nm}$ (● red); $\lambda_{\text{dom}} = 527 \text{ nm}$ (● true green); $\lambda_{\text{dom}} = 453 \text{ nm}$ (● deep blue); Cx = 0.31, Cy = 0.32 acc. to CIE 1931 (● ultra white)
- Corrosion Robustness Class: 3B
- ESD: 2 kV acc. to ANSI/ESDA/JEDEC JS-001 (HBM, Class 2)

Ordering Information

| Type | Brightness ¹⁾ | Ordering Code |
|---------------|--|---------------|
| LE RTDUW S2W | | Q65111A0884 |
| ● red | ● $\Phi_V = 45 \dots 112 \text{ lm}$ ($I_F = 700 \text{ mA}$) | |
| ● true green | ● $\Phi_V = 90 \dots 180 \text{ lm}$ ($I_F = 700 \text{ mA}$) | |
| ● deep blue | ● $\Phi_E = 630 \dots 900 \text{ mW}$ ($I_F = 700 \text{ mA}$) | |
| ● ultra white | ● $\Phi_V = 140 \dots 224 \text{ lm}$ ($I_F = 700 \text{ mA}$) | |

Maximum Ratings

| Parameter | Symbol | | Values | Values | Values | Values |
|---|----------------|------|---------|--------------|-------------|---------------|
| | | | ● red | ● true green | ● deep blue | ● ultra white |
| Operating Temperature | T_{op} | min. | -40 °C | -40 °C | -40 °C | -40 °C |
| | | max. | 85 °C | 85 °C | 85 °C | 85 °C |
| Storage Temperature | T_{stg} | min. | -40 °C | -40 °C | -40 °C | -40 °C |
| | | max. | 85 °C | 85 °C | 85 °C | 85 °C |
| Junction Temperature | T_j | max. | 125 °C | 125 °C | 125 °C | 125 °C |
| Forward Current $T_s = 25\text{ °C}$ | I_F | min. | 100 mA | 100 mA | 100 mA | 100 mA |
| | | max. | 1000 mA | 1000 mA | 1000 mA | 1000 mA |
| Forward Current pulsed $D = 0.5 ; f = 120\text{ Hz};$ $T_s = 25\text{ °C}$ | $I_{F\ pulse}$ | | 1500 mA | 1500 mA | 1500 mA | 1500 mA |
| ESD withstand voltage acc. to ANSI/ESDA/ JEDEC JS-001 (HBM, Class 2) | V_{ESD} | | 2 kV | 2 kV | 2 kV | 2 kV |
| Reverse current ²⁾ | I_R | max. | 200 mA | 200 mA | 200 mA | 200 mA |

Characteristics

$I_F = 700 \text{ mA}$; $T_s = 25 \text{ °C}$

| Parameter | Symbol | | Values | | | |
|---|-------------------------|--------------------|--------------------------|--------------|-------------|---------------|
| | | | ● red | ● true green | ● deep blue | ● ultra white |
| Chromaticity Coordinate | | | | | | 0.31 0.32 |
| Peak Wavelength | λ_{peak} | typ. | 632 nm | 520 nm | 449 nm | |
| Dominant Wavelength ³⁾ | λ_{dom} | min. | 620 nm | 521 nm | 449 nm | |
| | | typ. ³⁾ | 625 nm | 527 nm | 453 nm | |
| | | max. | 632 nm | 533 nm | 457 nm | |
| Spectral bandwidth at 50% $I_{\text{rel,max}}$ | $\Delta\lambda$ | typ. | 18 nm | 33 nm | 25 nm | |
| Viewing angle at 50% I_V | 2ϕ | typ. | 120 ° | 120 ° | 120 ° | 120 ° |
| Radiating surface For value(s) see red column, all chips operated simultaneously | A_{color} | typ. | 2.1 x 2.1 m ² | | | |
| Partial Flux acc. CIE 127:2007 ⁴⁾ $\Phi_{E/V 120^\circ} = x * \Phi_{E/V 180^\circ}$ | $\Phi_{E/V, 120^\circ}$ | typ. | 0.82 | 0.82 | 0.82 | 0.82 |
| Forward Voltage ⁵⁾ $I_F = 700 \text{ mA}$ | V_F | min. | 2.10 V | 2.90 V | 2.90 V | 2.90 V |
| | | typ. | 2.50 V | 3.60 V | 3.45 V | 3.45 V |
| | | max. | 2.90 V | 4.20 V | 4.00 V | 4.00 V |
| Reverse voltage (ESD device) | $V_{R \text{ ESD}}$ | min. | 5 V | 5 V | 5 V | 5 V |
| Reverse voltage ²⁾ $I_R = 20 \text{ mA}$ | V_R | max. | 1.2 V | 1.2 V | 1.2 V | 1.2 V |
| Real thermal resistance junction/solderpoint ⁶⁾ For value(s) see red column, all chips operated simultaneously | $R_{\text{thJS real}}$ | typ. | 1.8 K / W | | | |
| | | max. | 2.3 K / W | | | |
| Electrical thermal resistance junction/solderpoint ⁶⁾ With efficiency $\eta_e = 23\%$; for value(s) see red column, all chips operated simultaneously | $R_{\text{thJS elec.}}$ | typ. | 1.4 K / W | | | |
| | | max. | 1.8 K / W | | | |

Brightness Groups

| Color of emission | Group | Luminous Flux ¹⁾ $I_F = 700 \text{ mA}$ min. Φ_V | Luminous Flux ¹⁾ $I_F = 700 \text{ mA}$ max. Φ_V |
|-------------------|-------|---|---|
| ● red | JA | 45 lm | 56 lm |
| ● red | JB | 56 lm | 71 lm |
| ● red | KA | 71 lm | 90 lm |
| ● red | KB | 90 lm | 112 lm |
| ● true green | KB | 90 lm | 112 lm |
| ● true green | LA | 112 lm | 140 lm |
| ● true green | LB | 140 lm | 180 lm |
| ● deep blue | 1V | 710 mW | 800 mW |
| ● deep blue | 2V | 800 mW | 900 mW |
| ● deep blue | 4U | 630 mW | 710 mW |
| ● ultra white | LB | 140 lm | 180 lm |
| ● ultra white | MA | 180 lm | 224 lm |

Wavelength Groups

- true green

| Group | Dominant Wavelength ³⁾ min. λ_{dom} | Dominant Wavelength ³⁾ max. λ_{dom} |
|-------|---|---|
| 3 | 521 nm | 527 nm |
| 4 | 527 nm | 533 nm |

Wavelength Groups

- deep blue

| Group | Dominant Wavelength ³⁾ min. λ_{dom} | Dominant Wavelength ³⁾ max. λ_{dom} |
|-------|---|---|
| 3 | 449 nm | 453 nm |
| 4 | 453 nm | 457 nm |

Chromaticity Coordinate Groups

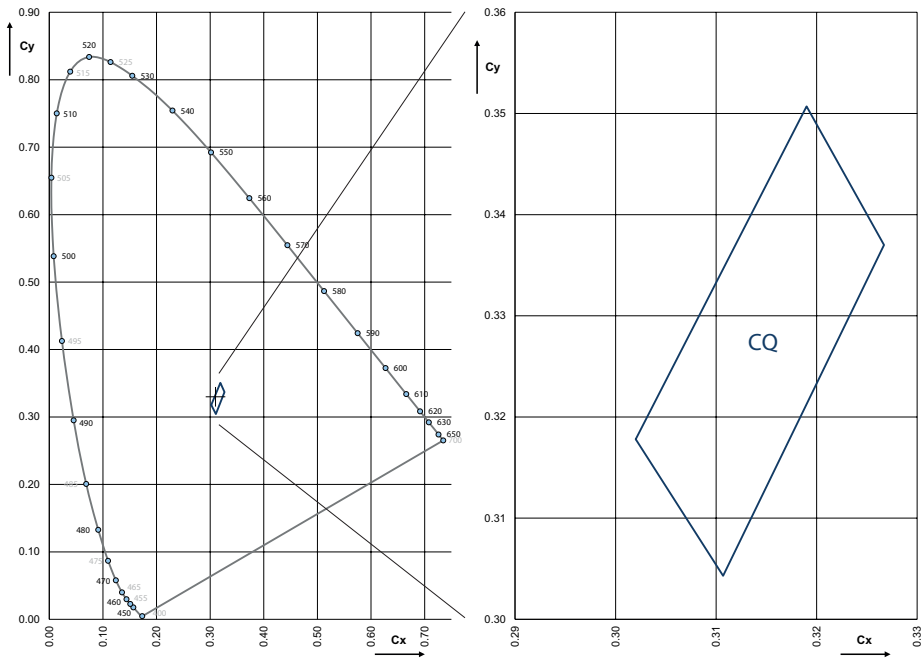

Color Chromaticity Groups

- ultra white

| Group | Cx | Cy |
|-------|--------|--------|
| CQ | 0.3190 | 0.3507 |
| | 0.3267 | 0.3370 |
| | 0.3107 | 0.3043 |
| | 0.3020 | 0.3178 |

Relative Spectral Emission ⁴⁾

$\Phi_{rel} = f(\lambda); I_F = 700 \text{ mA}; T_J = 25 \text{ }^\circ\text{C}$

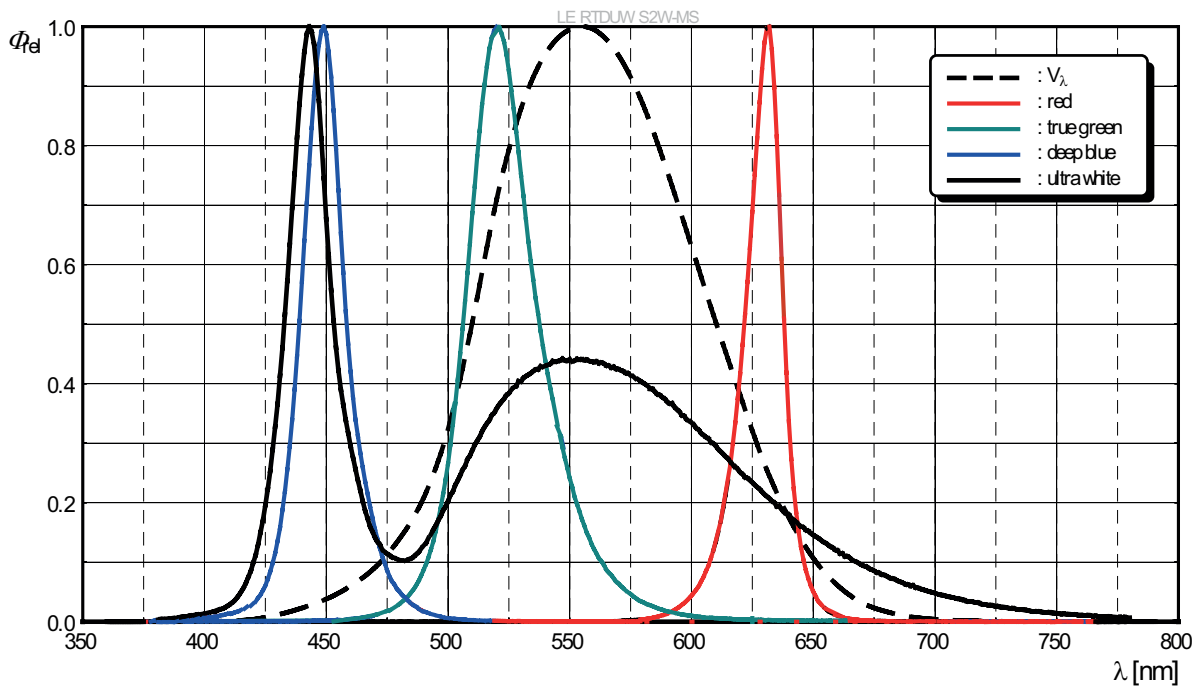

Radiation Characteristics ⁴⁾

$I_{rel} = f(\phi); T_J = 25 \text{ }^\circ\text{C}$

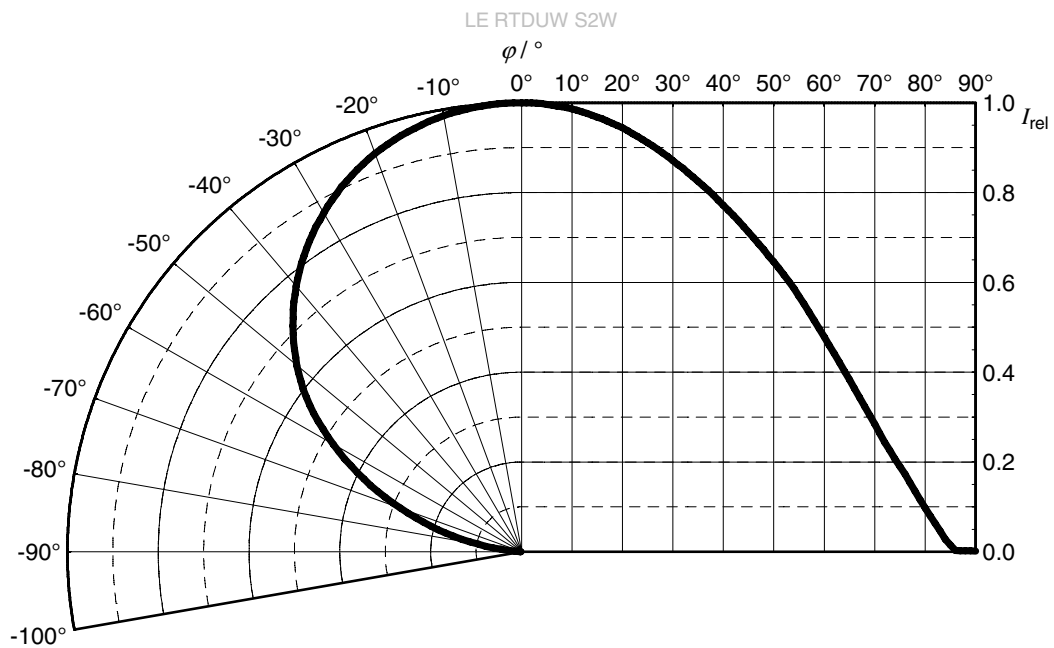

Not for new design

Relative Partial Flux ⁴⁾

$$\Phi_{V/E}(2\varphi)/\Phi_{V/E}(180^\circ) = f(\varphi); T_J = 25^\circ\text{C}$$

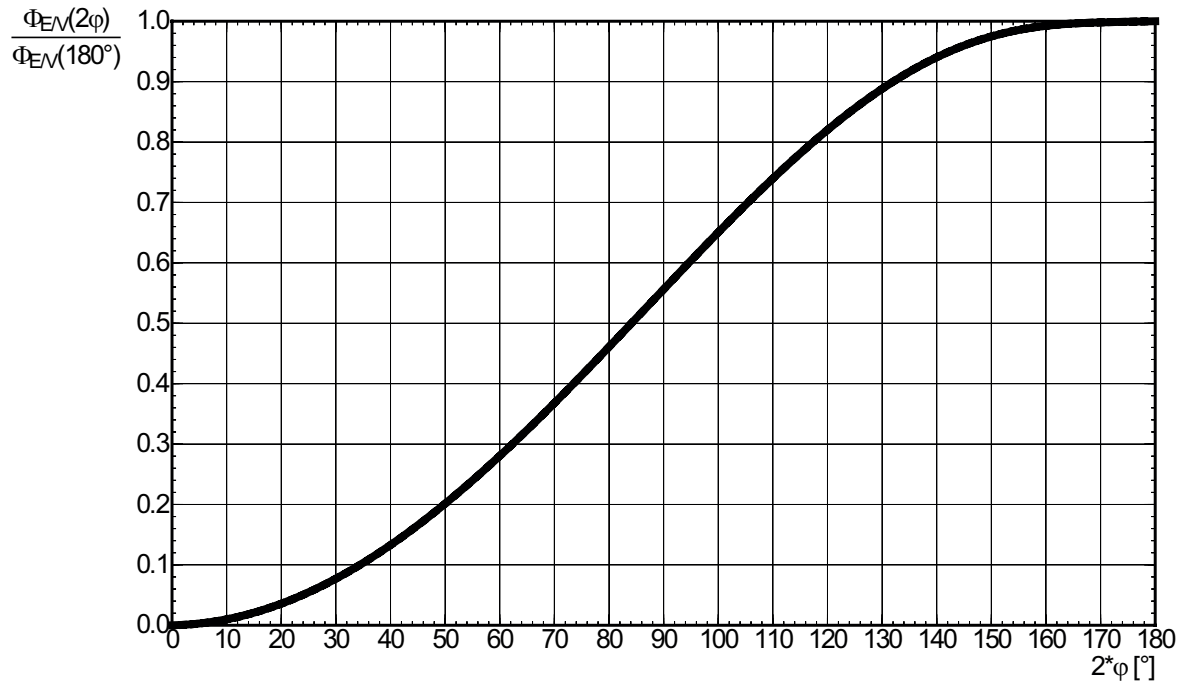

Forward current 4), 7)

$I_F = f(V_F); T_J = 25\text{ }^\circ\text{C}$

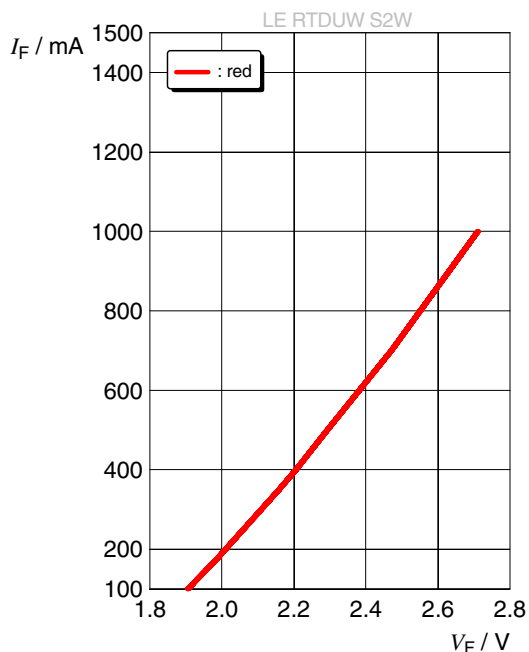

Forward current 4), 7)

$I_F = f(V_F); T_J = 25\text{ }^\circ\text{C}$

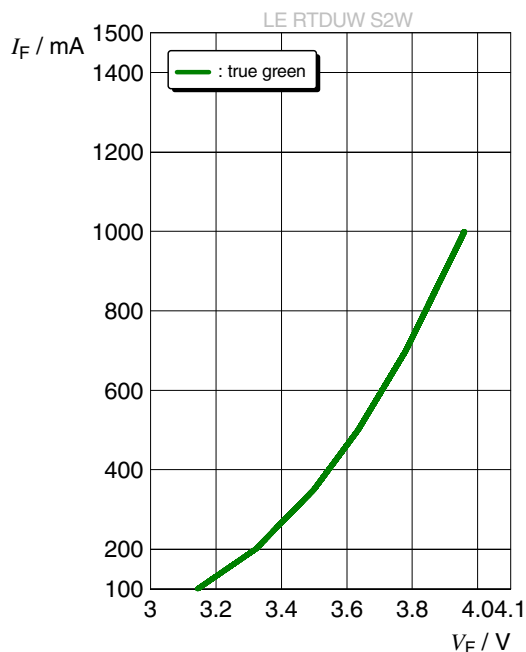

Forward current 4), 7)

$I_F = f(V_F); T_J = 25\text{ }^\circ\text{C}$

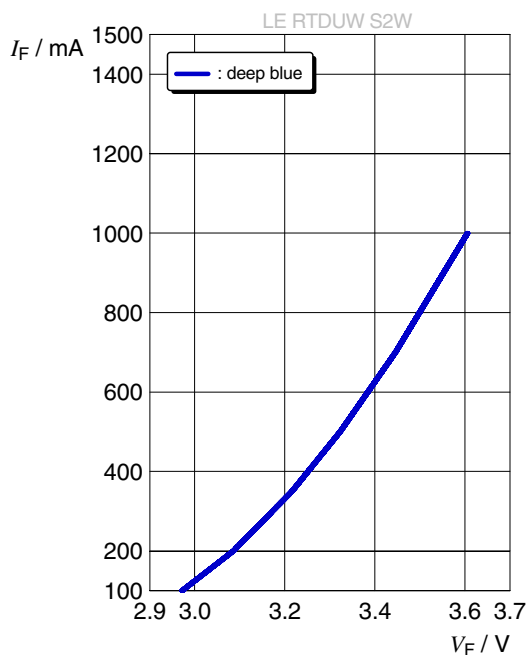

Forward current 4), 7)

$I_F = f(V_F); T_J = 25\text{ }^\circ\text{C}$

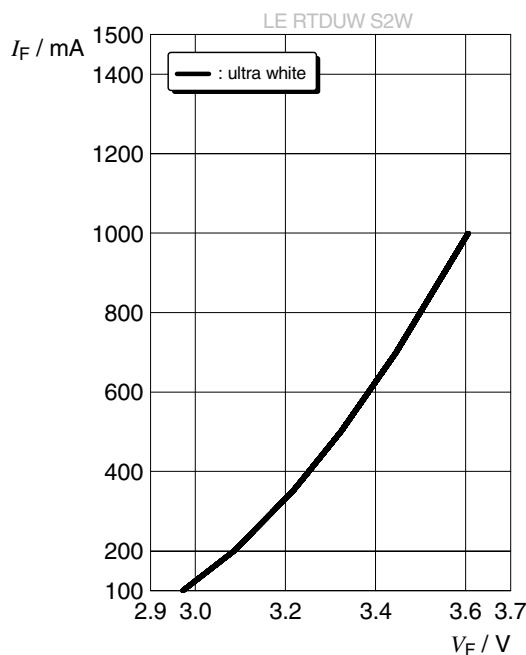

Not for new design

Relative Luminous Flux 4), 7)

$\Phi_V / \Phi_V(700\text{ mA}) = f(I_F); T_J = 25\text{ }^\circ\text{C}$

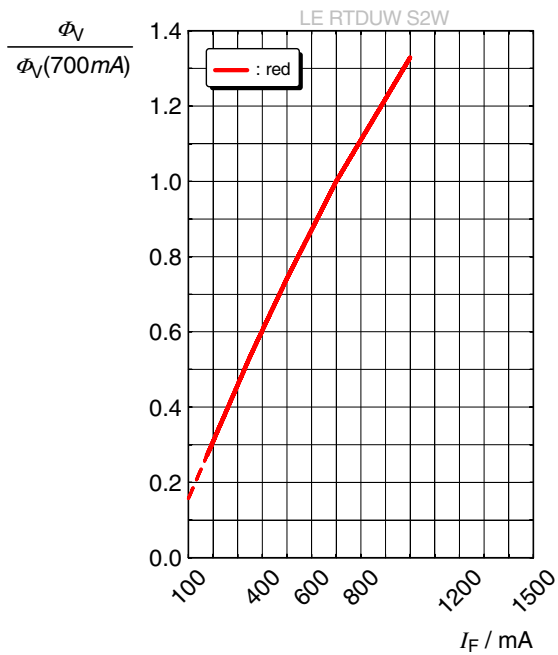

Relative Luminous Flux 4), 7)

$\Phi_V / \Phi_V(700\text{ mA}) = f(I_F); T_J = 25\text{ }^\circ\text{C}$

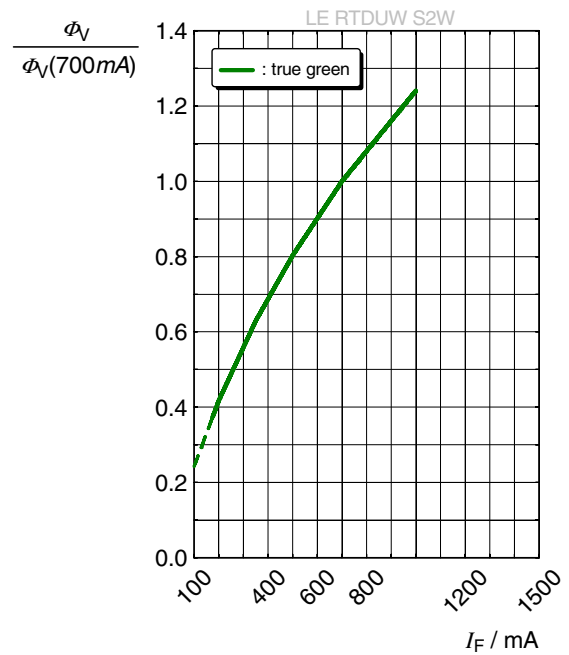

Relative Radiant Power 4), 7)

$\Phi_E / \Phi_E(700\text{ mA}) = f(I_F); T_J = 25\text{ }^\circ\text{C}$

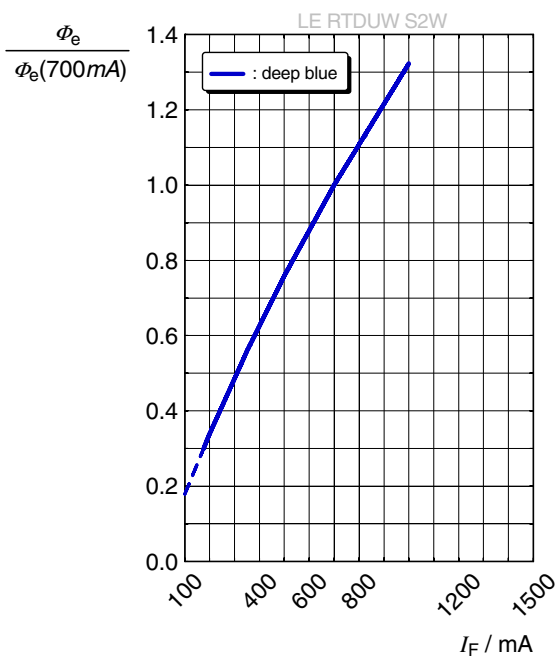

Relative Luminous Flux 4), 7)

$\Phi_V / \Phi_V(700\text{ mA}) = f(I_F); T_J = 25\text{ }^\circ\text{C}$

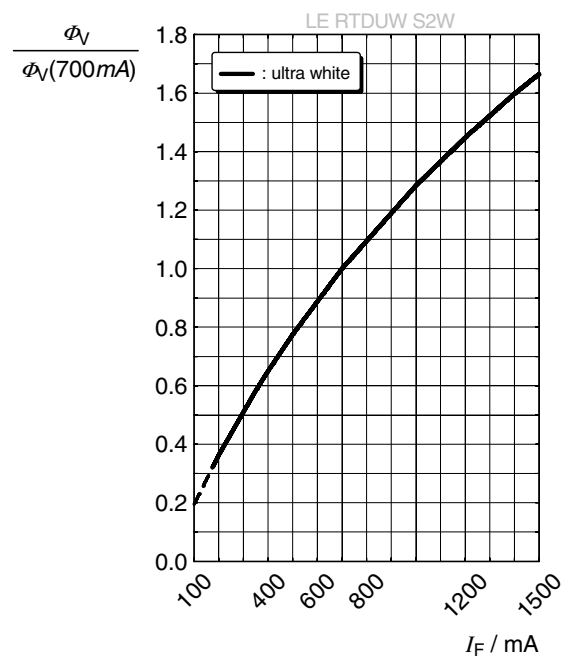

Not for new design

Dominant Wavelength ⁴⁾

$$\Delta\lambda_{\text{dom}} = f(I_F); T_J = 25\text{ }^\circ\text{C}$$

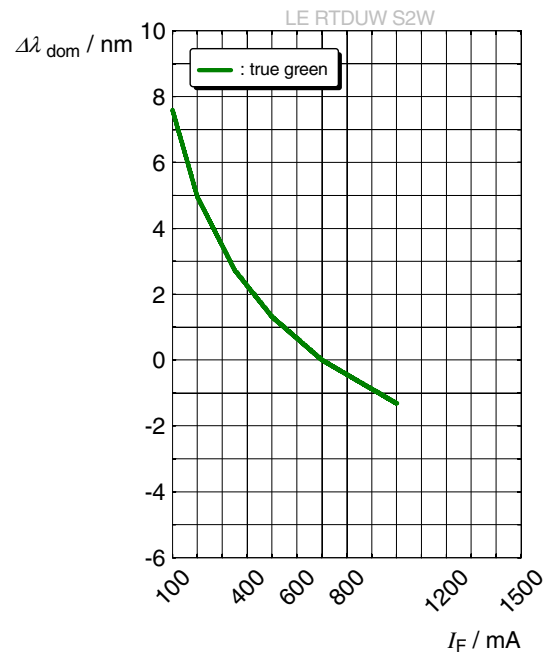

Dominant Wavelength ⁴⁾

$$\Delta\lambda_{\text{dom}} = f(I_F); T_J = 25\text{ }^\circ\text{C}$$

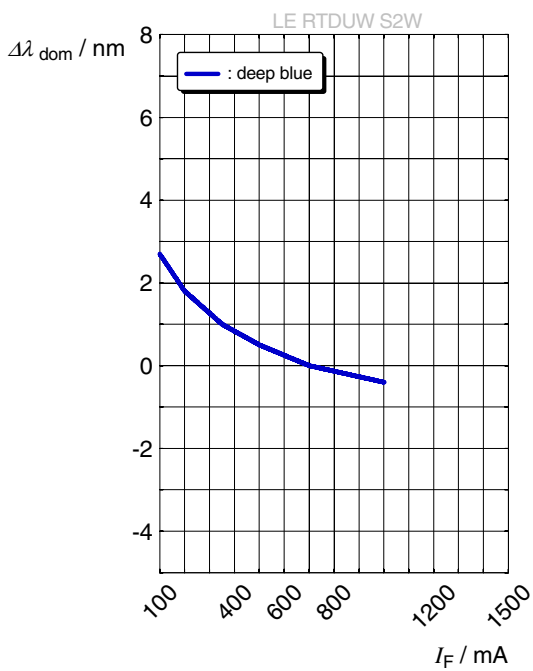

Chromaticity Coordinate Shift ⁴⁾

$$\Delta C_x, \Delta C_y = f(I_F); T_J = 25\text{ }^\circ\text{C}$$

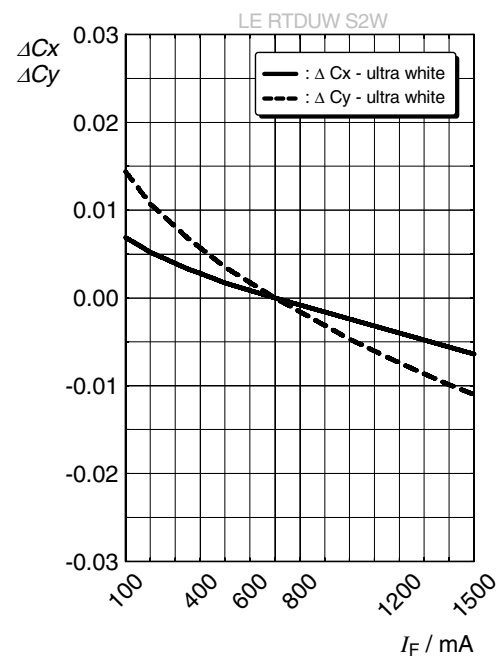

Not for new design

Forward Voltage ⁴⁾

$$\Delta V_F = V_F - V_F(25\text{ }^\circ\text{C}) = f(T_j); I_F = 700\text{ mA}$$

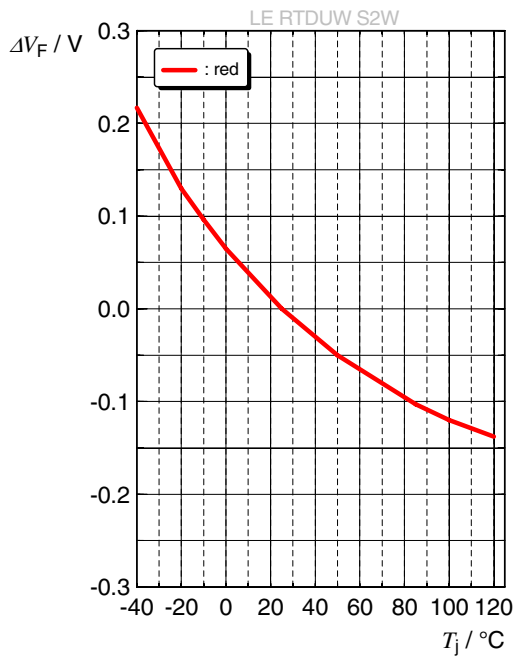

Forward Voltage ⁴⁾

$$\Delta V_F = V_F - V_F(25\text{ }^\circ\text{C}) = f(T_j); I_F = 700\text{ mA}$$

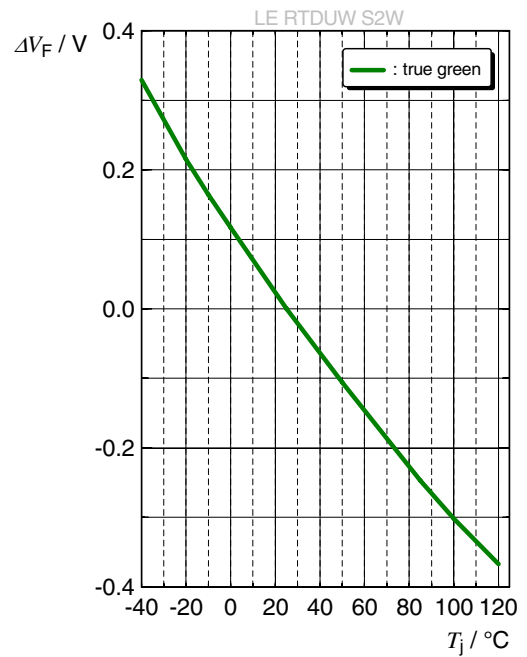

Forward Voltage ⁴⁾

$$\Delta V_F = V_F - V_F(25\text{ }^\circ\text{C}) = f(T_j); I_F = 700\text{ mA}$$

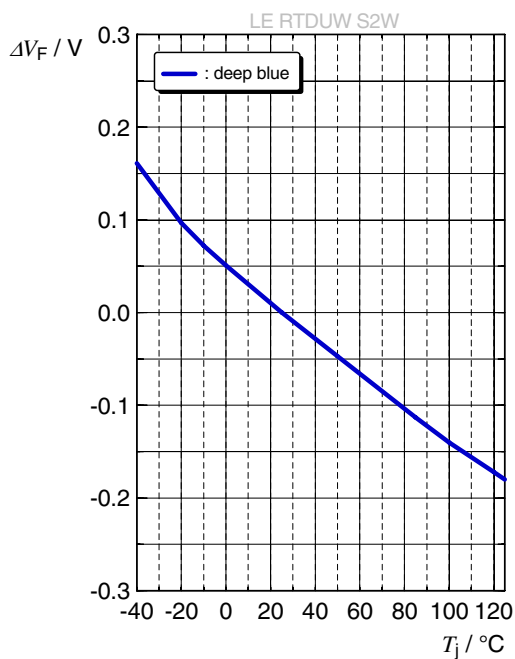

Forward Voltage ⁴⁾

$$\Delta V_F = V_F - V_F(25\text{ }^\circ\text{C}) = f(T_j); I_F = 700\text{ mA}$$

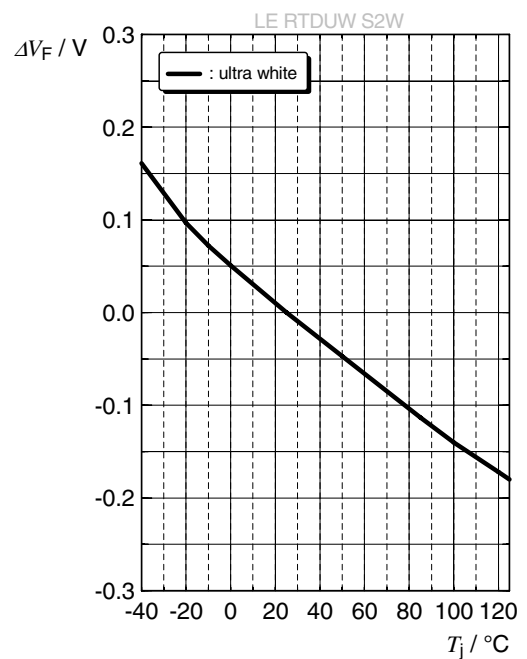

Not for new design

Relative Luminous Flux ⁴⁾

$\Phi_V / \Phi_V(25^\circ\text{C}) = f(T_j); I_F = 700\text{ mA}$

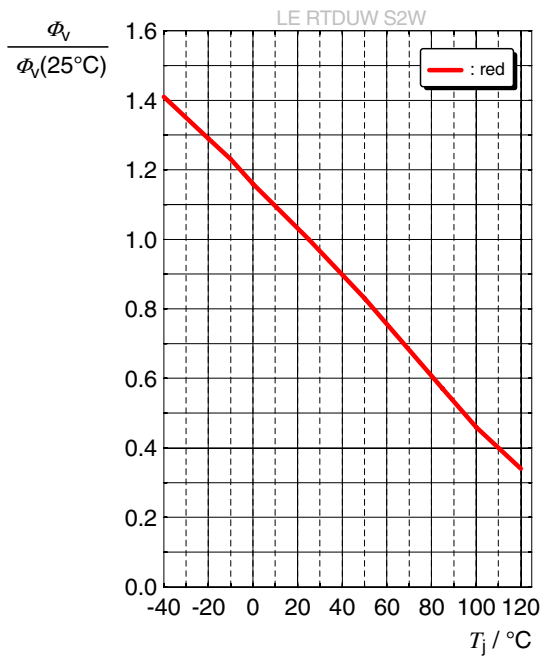

Relative Luminous Flux ⁴⁾

$\Phi_V / \Phi_V(25^\circ\text{C}) = f(T_j); I_F = 700\text{ mA}$

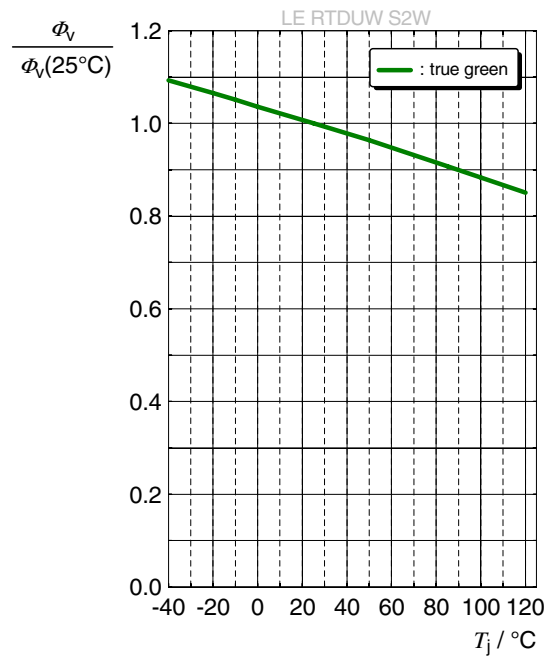

Relative Radiant Power ⁴⁾

$\Phi_E / \Phi_E(25^\circ\text{C}) = f(T_j); I_F = 700\text{ mA}$

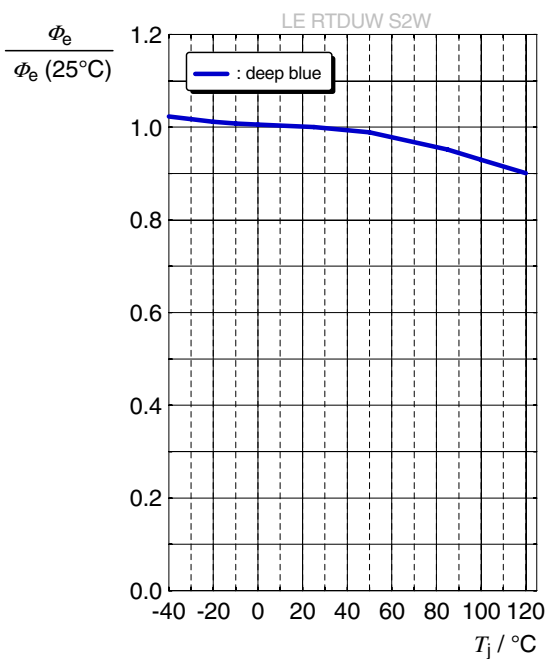

Relative Luminous Flux ⁴⁾

$\Phi_V / \Phi_V(25^\circ\text{C}) = f(T_j); I_F = 700\text{ mA}$

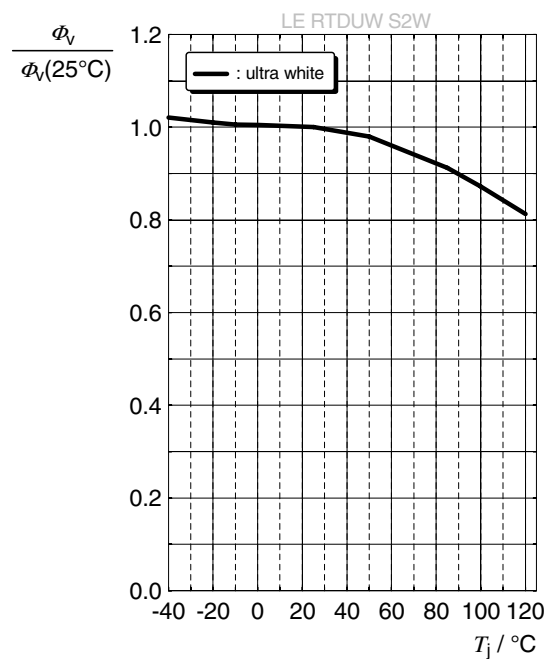

Not for new design

Dominant Wavelength ⁴⁾

$$\Delta\lambda_{\text{dom}} = \lambda_{\text{dom}} - \lambda_{\text{dom}}(25\text{ }^\circ\text{C}) = f(T_j); I_F = 700\text{ mA}$$

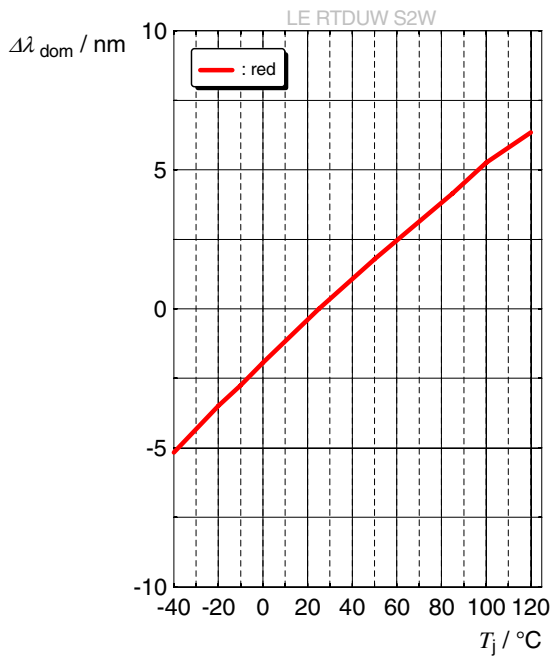

Dominant Wavelength ⁴⁾

$$\Delta\lambda_{\text{dom}} = \lambda_{\text{dom}} - \lambda_{\text{dom}}(25\text{ }^\circ\text{C}) = f(T_j); I_F = 700\text{ mA}$$

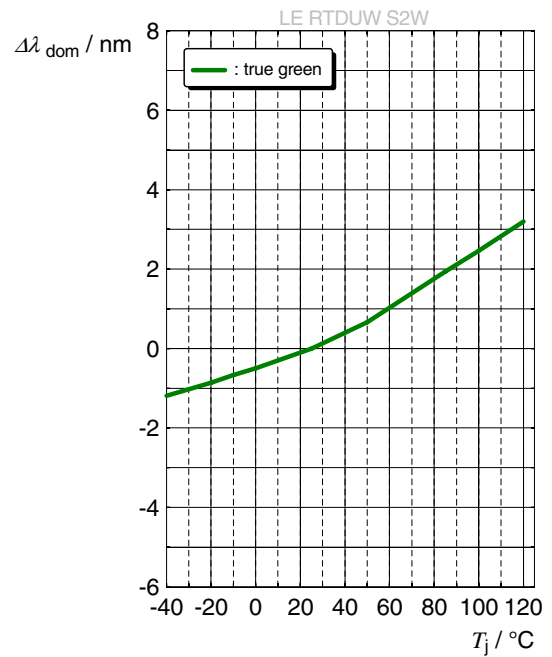

Dominant Wavelength ⁴⁾

$$\Delta\lambda_{\text{dom}} = \lambda_{\text{dom}} - \lambda_{\text{dom}}(25\text{ }^\circ\text{C}) = f(T_j); I_F = 700\text{ mA}$$

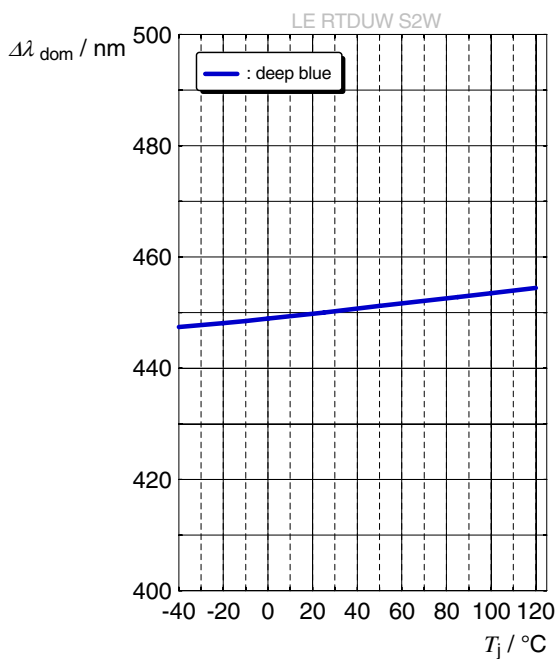

Chromaticity Coordinate Shift ⁴⁾

$$\Delta C_x, \Delta C_y = f(T_j); I_F = 700\text{ mA}$$

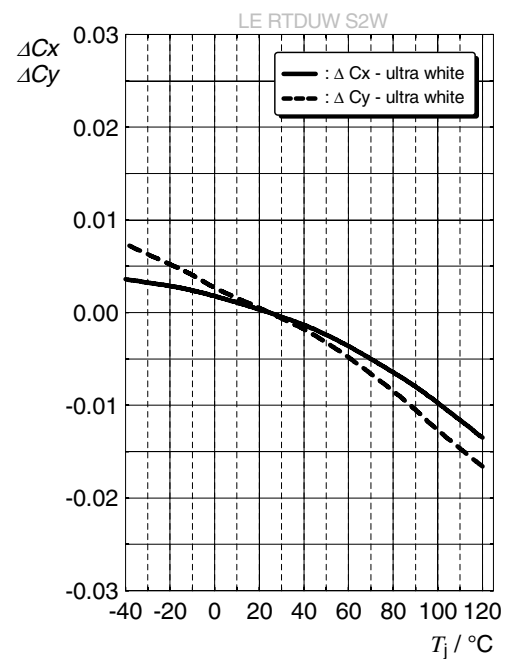

Not for new design

Max. Permissible Forward Current

$I_F = f(T_S)$; for 4 Chip operated

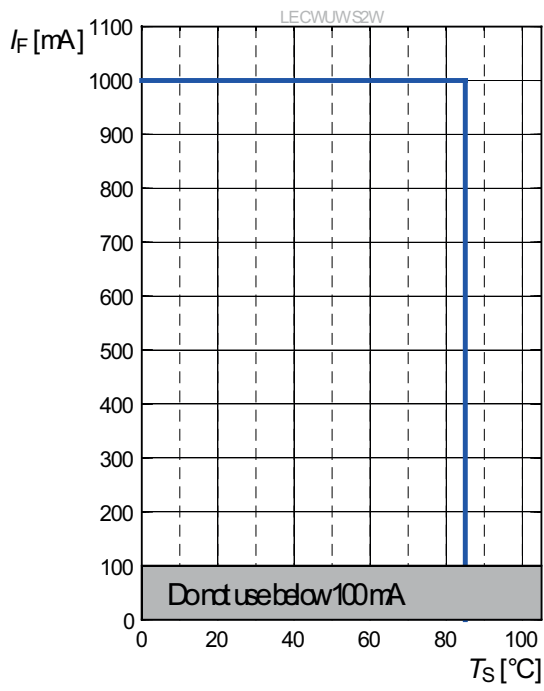

Dimensional Drawing ⁸⁾

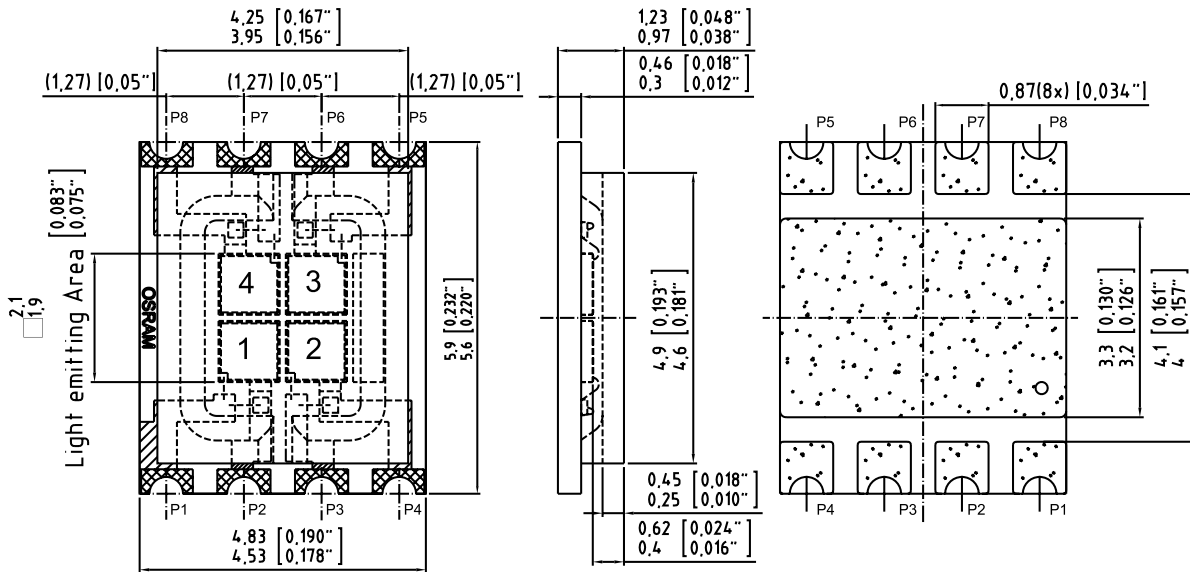

C63062-A4028-A1...-09

Approximate Weight: 66.0 mg

Corrosion test: Class: 3B
 Test condition: 40°C / 90 % RH / 15 ppm H₂S / 14 days (stricter then IEC 60068-2-43)

ESD advice: The device is protected by ESD device which is connected in parallel to the Chip.

Electrical internal circuit

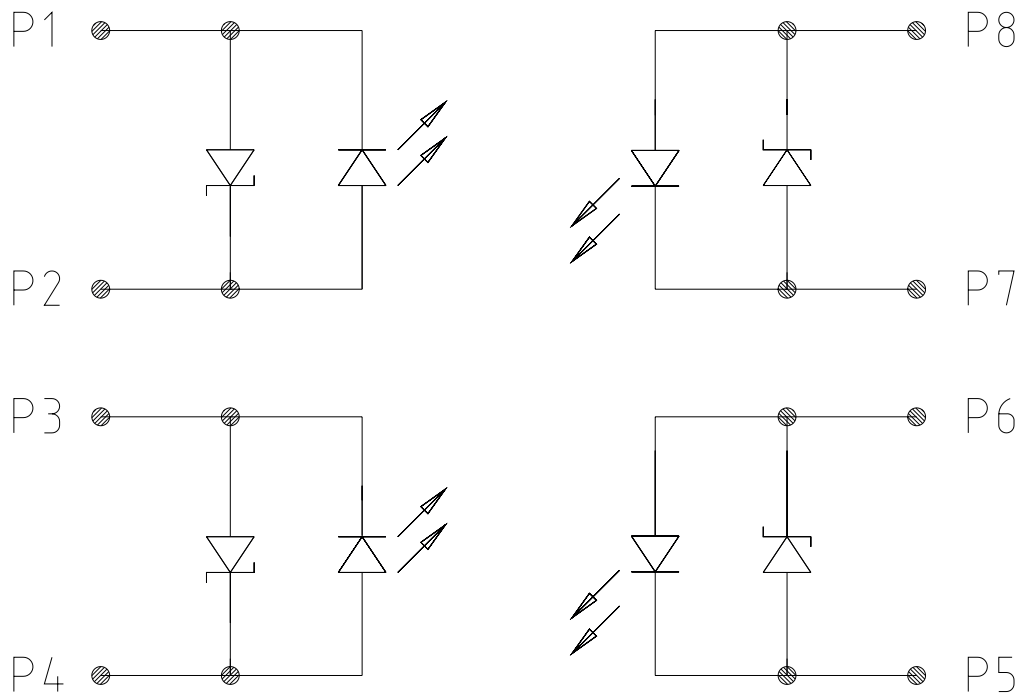

| Pin | Description |
|-------|------------------------------|
| Pin 1 | Cathode Chip 1 (red) |
| Pin 2 | Anode Chip 1 (red) |
| Pin 3 | Cathode Chip 2 (true green) |
| Pin 4 | Anode Chip 2 (true green) |
| Pin 5 | Cathode Chip 3 (deep blue) |
| Pin 6 | Anode Chip 3 (deep blue) |
| Pin 7 | Cathode Chip 4 (ultra white) |
| Pin 8 | Anode Chip 4 (ultra white) |

Not for new design

Recommended Solder Pad ⁸⁾

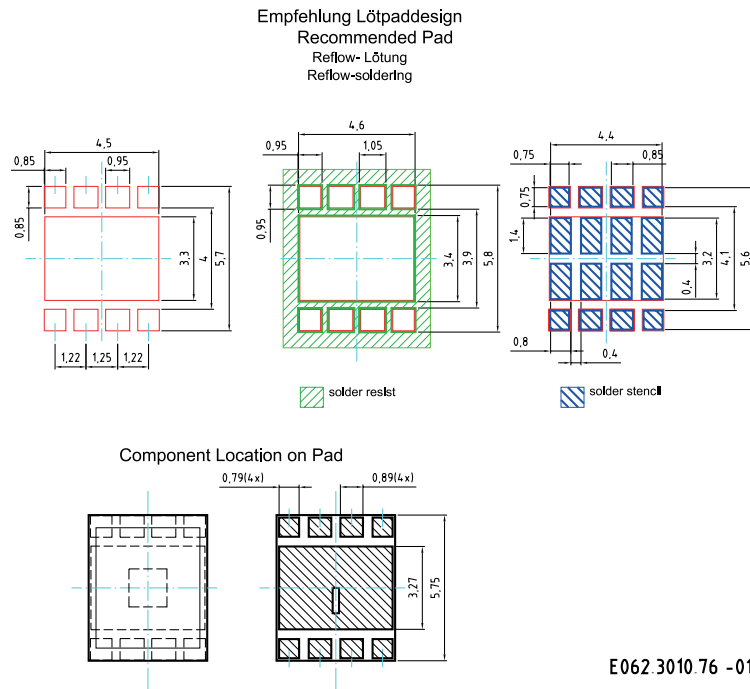

For superior solder joint connectivity results we recommend soldering under standard nitrogen atmosphere. Package not suitable for any kind of wet cleaning or ultrasonic cleaning.

Reflow Soldering Profile

Product complies to MSL Level 2 acc. to JEDEC J-STD-020E

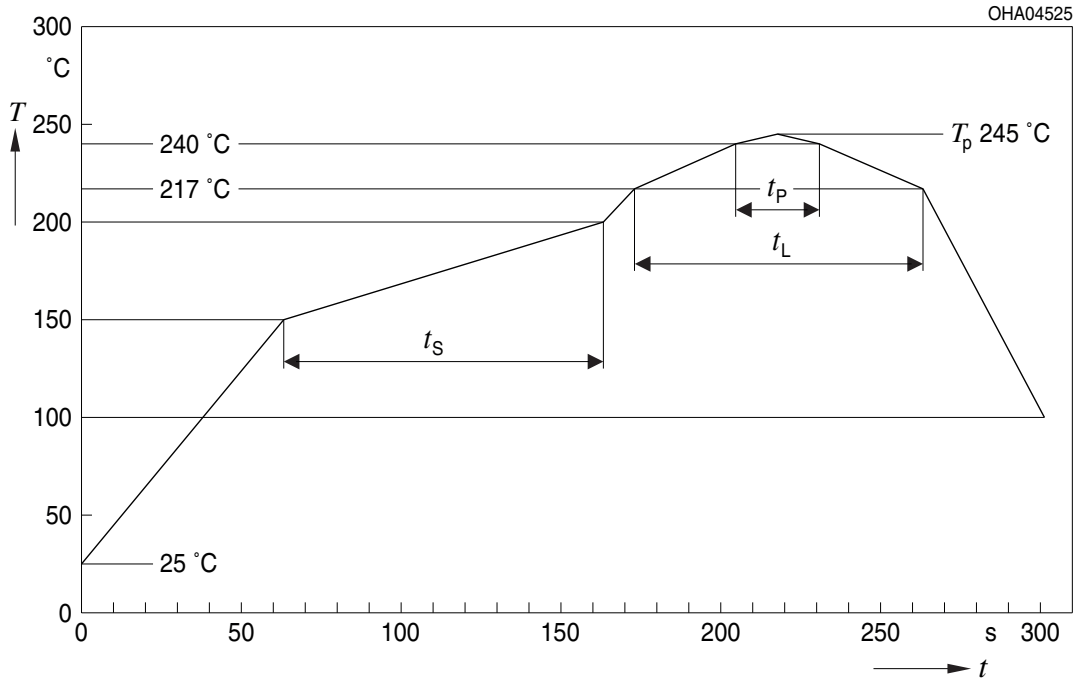

| Profile Feature | Symbol | Pb-Free (SnAgCu) Assembly | | | Unit |
|--|--------|---------------------------|----------------|---------|------|
| | | Minimum | Recommendation | Maximum | |
| Ramp-up rate to preheat ^{*)} 25 °C to 150 °C | | | 2 | 3 | K/s |
| Time t_s T_{Smin} to T_{Smax} | t_s | 60 | 100 | 120 | s |
| Ramp-up rate to peak ^{*)} T_{Smax} to T_p | | | 2 | 3 | K/s |
| Liquidus temperature | T_L | | 217 | | °C |
| Time above liquidus temperature | t_L | | 80 | 100 | s |
| Peak temperature | T_p | | 245 | 260 | °C |
| Time within 5 °C of the specified peak temperature $T_p - 5$ K | t_p | 10 | 20 | 30 | s |
| Ramp-down rate* T_p to 100 °C | | | 3 | 6 | K/s |
| Time 25 °C to T_p | | | | 480 | s |

All temperatures refer to the center of the package, measured on the top of the component
 *) slope calculation DT/Dt : Dt max. 5 s; fulfillment for the whole T-range

Not for new design

Taping ⁸⁾

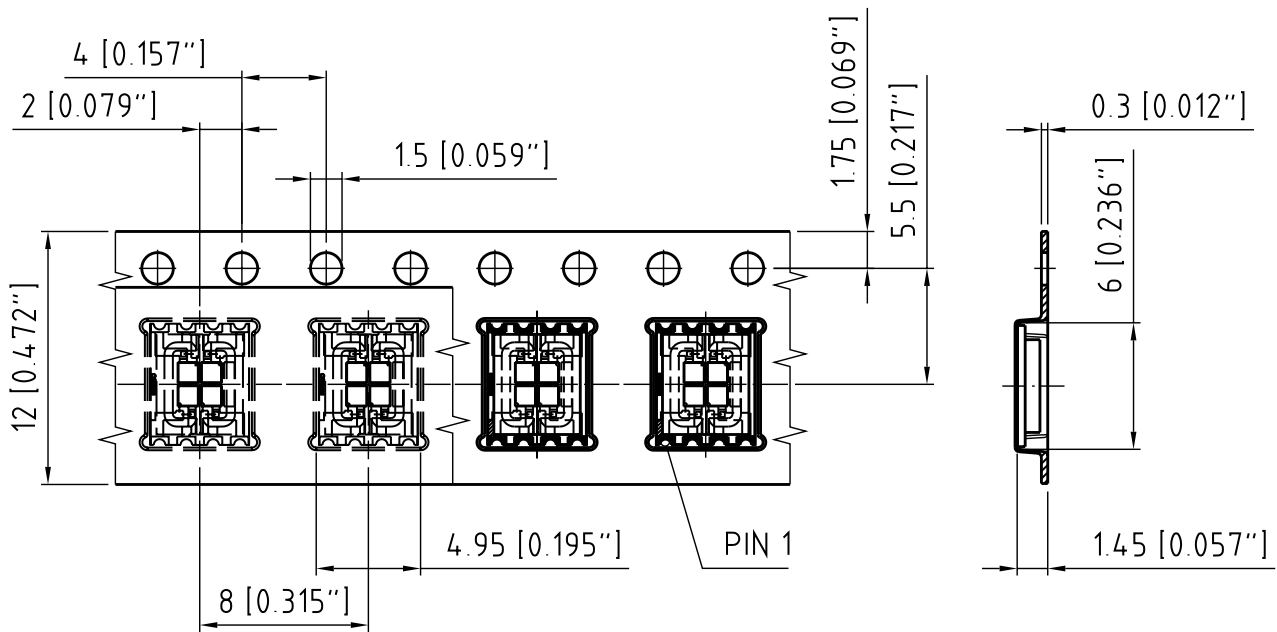

C63062-A3985-B7-03

Tape and Reel ⁹⁾

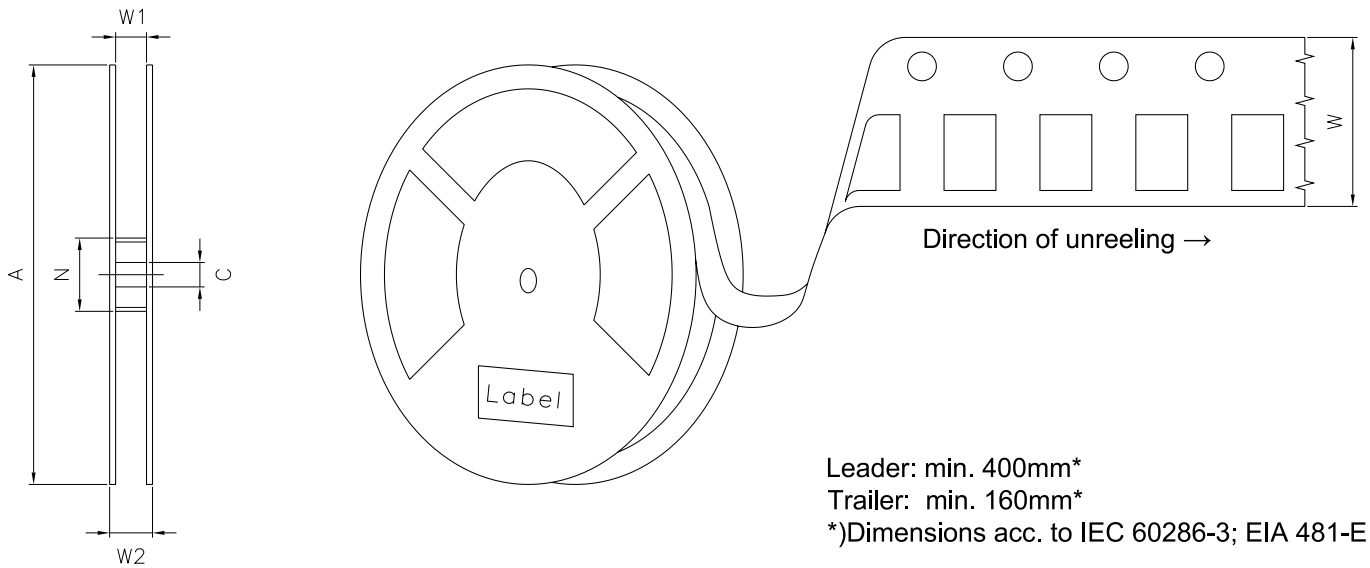

Reel dimensions [mm]

| A | W | N _{min} | W ₁ | W _{2max} | Pieces per PU |
|--------|------------------|------------------|----------------|-------------------|---------------|
| 180 mm | 12 + 0.3 / - 0.1 | 60 | 12.4 + 2 | 18.4 | 500 |

Not for new design

Barcode-Product-Label (BPL)

OSRAM Opto Semiconductors LX XXXX BIN1: XX-XX-X-XXX-X

RoHS Compliant

(6P) BATCH NO: 1234567890 ML Temp ST
X XXX °C X

(1T) LOT NO: 1234567890 (9D) D/C: 1234

(X) PROD NO: 123456789(Q)QTY: 9999 (G) GROUP: XX-XX-X-X

Pack: RXX
DEMY XXX
X_X123_1234.1234 X



OHA04563

Dry Packing Process and Materials ⁸⁾

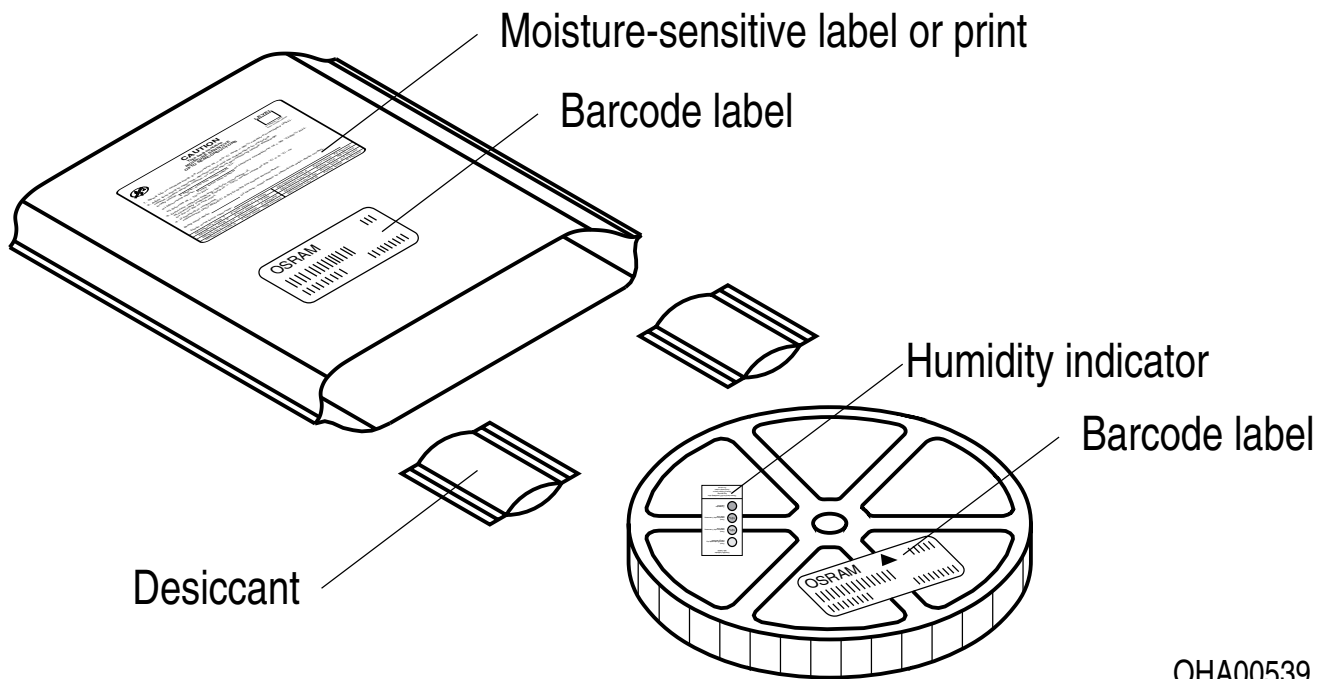

OHA00539

Moisture-sensitive product is packed in a dry bag containing desiccant and a humidity card according JEDEC-STD-033.

Not for new design

Schematic transportation box ⁸⁾

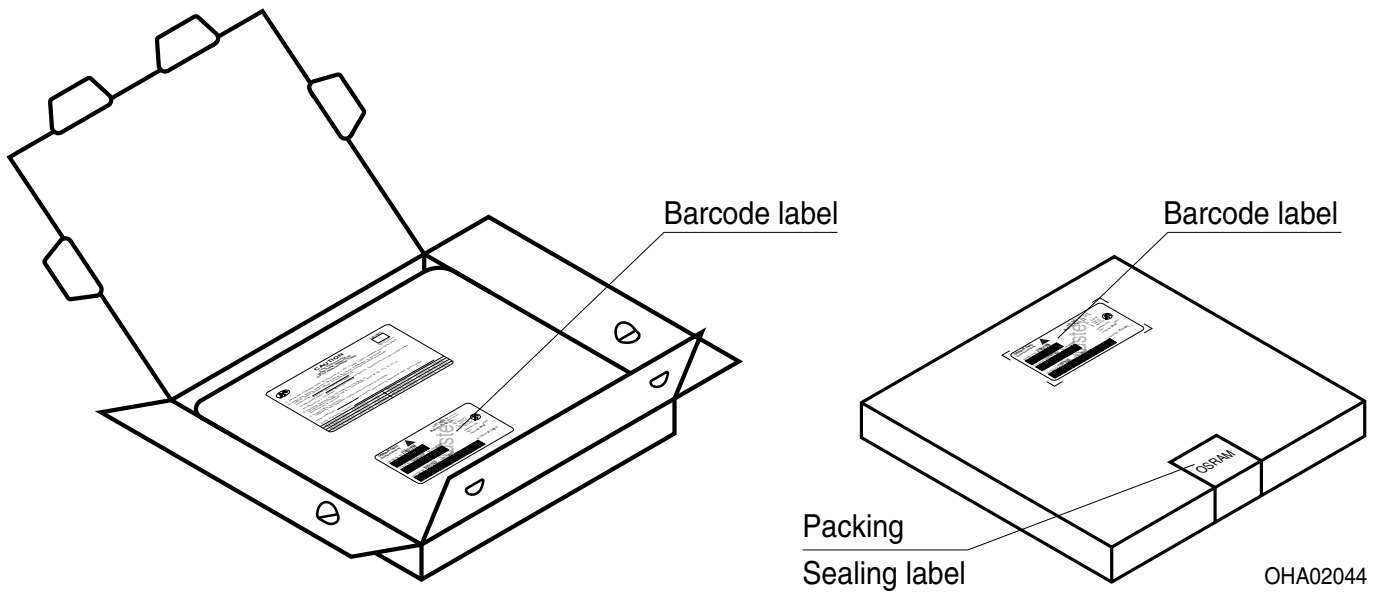

Dimensions of transportation box in mm

| Width | Length | Height |
|------------|------------|-----------|
| 195 ± 5 mm | 195 ± 5 mm | 30 ± 5 mm |

Type Designation System

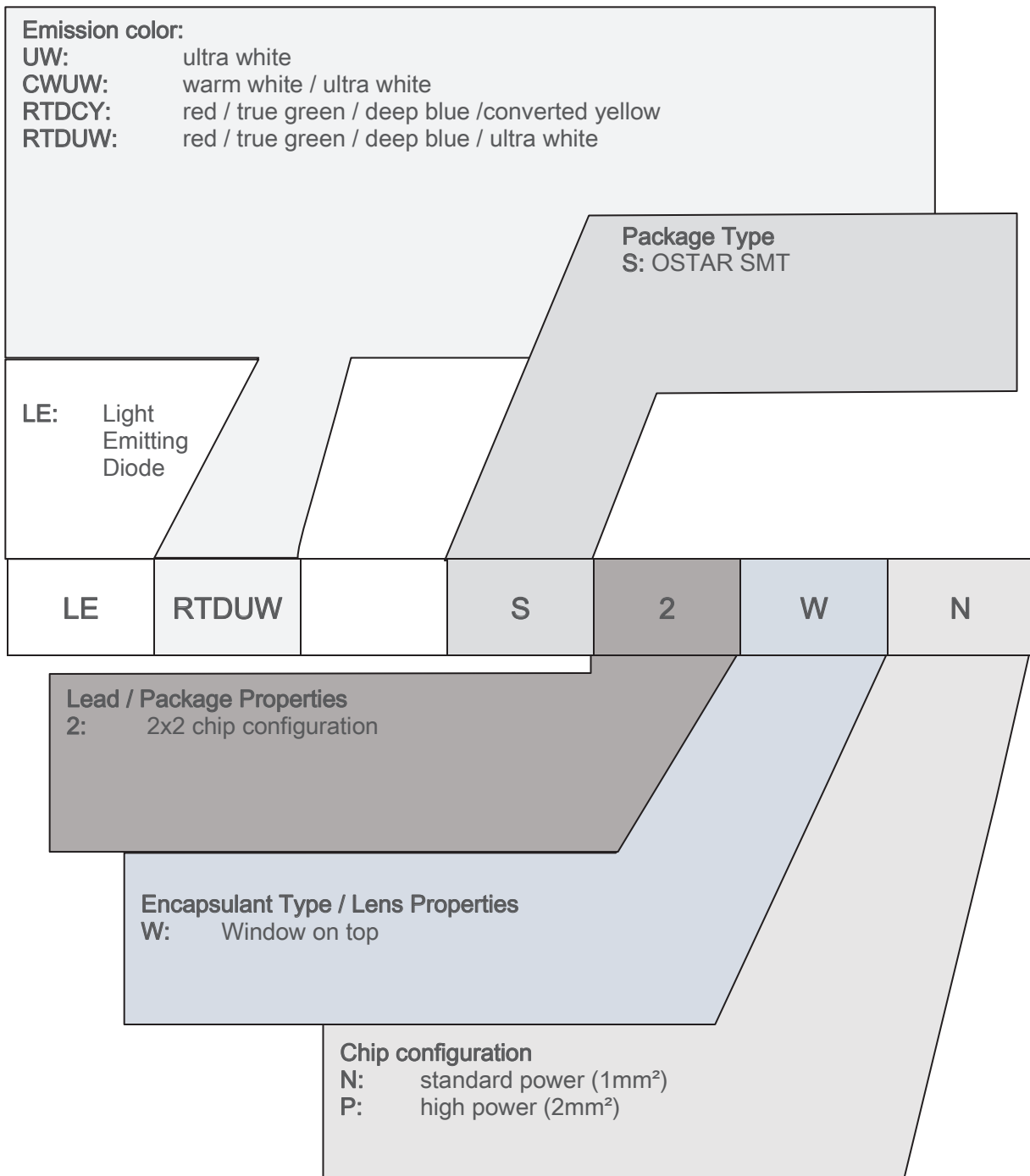

Not for new design

Notes

The evaluation of eye safety occurs according to the standard IEC 62471:2006 (photo biological safety of lamps and lamp systems). Within the risk grouping system of this IEC standard, the device specified in this data sheet falls into the class **moderate risk (exposure time 0.25 s)**. Under real circumstances (for exposure time, conditions of the eye pupils, observation distance), it is assumed that no endangerment to the eye exists from these devices. As a matter of principle, however, it should be mentioned that intense light sources have a high secondary exposure potential due to their blinding effect. When looking at bright light sources (e.g. headlights), temporary reduction in visual acuity and afterimages can occur, leading to irritation, annoyance, visual impairment, and even accidents, depending on the situation.

Subcomponents of this device contain, in addition to other substances, metal filled materials including silver. Metal filled materials can be affected by environments that contain traces of aggressive substances. Therefore, we recommend that customers minimize device exposure to aggressive substances during storage, production, and use. Devices that showed visible discoloration when tested using the described tests above did show no performance deviations within failure limits during the stated test duration. Respective failure limits are described in the IEC60810.

For further application related informations please visit www.osram-os.com/appnotes

Disclaimer

Attention please!

The information describes the type of component and shall not be considered as assured characteristics. Terms of delivery and rights to change design reserved. Due to technical requirements components may contain dangerous substances.

For information on the types in question please contact our Sales Organization.

If printed or downloaded, please find the latest version on the OSRAM OS website.

Packing

Please use the recycling operators known to you. We can also help you – get in touch with your nearest sales office.

By agreement we will take packing material back, if it is sorted. You must bear the costs of transport. For packing material that is returned to us unsorted or which we are not obliged to accept, we shall have to invoice you for any costs incurred.

Product safety devices/applications or medical devices/applications

OSRAM OS components are not developed, constructed or tested for the application as safety relevant component or for the application in medical devices.

In case Buyer – or Customer supplied by Buyer– considers using OSRAM OS components in product safety devices/applications or medical devices/applications, Buyer and/or Customer has to inform the local sales partner of OSRAM OS immediately and OSRAM OS and Buyer and /or Customer will analyze and coordinate the customer-specific request between OSRAM OS and Buyer and/or Customer.

Glossary

- 1) **Brightness:** Brightness values are measured during a current pulse of typically 25 ms, with an internal reproducibility of $\pm 8\%$ and an expanded uncertainty of $\pm 11\%$ (acc. to GUM with a coverage factor of $k = 3$).
- 2) **Reverse Operation:** Reverse Operation of 10 hours is permissible in total. Continuous reverse operation is not allowed.
- 3) **Wavelength:** The wavelength is measured at a current pulse of typically 25 ms, with an internal reproducibility of ± 0.5 nm and an expanded uncertainty of ± 1 nm (acc. to GUM with a coverage factor of $k = 3$).
- 4) **Typical Values:** Due to the special conditions of the manufacturing processes of semiconductor devices, the typical data or calculated correlations of technical parameters can only reflect statistical figures. These do not necessarily correspond to the actual parameters of each single product, which could differ from the typical data and calculated correlations or the typical characteristic line. If requested, e.g. because of technical improvements, these typ. data will be changed without any further notice.
- 5) **Forward Voltage:** The forward voltage is measured during a current pulse of typically 8 ms, with an internal reproducibility of ± 0.05 V and an expanded uncertainty of ± 0.1 V (acc. to GUM with a coverage factor of $k = 3$).
- 6) **Thermal Resistance:** $R_{th\ max}$ is based on statistic values (6σ).
- 7) **Characteristic curve:** In the range where the line of the graph is broken, you must expect higher differences between single devices within one packing unit.
- 8) **Tolerance of Measure:** Unless otherwise noted in drawing, tolerances are specified with ± 0.1 and dimensions are specified in mm.
- 9) **Tape and Reel:** All dimensions and tolerances are specified acc. IEC 60286-3 and specified in mm.

Revision History

| Version | Date | Change |
|---------|------------|-----------------|
| 1.2 | 2018-11-28 | Characteristics |

Published by OSRAM Opto Semiconductors GmbH EU RoHS and China RoHS compliant product
Leibnizstraße 4, D-93055 Regensburg
www.osram-os.com © All Rights Reserved.



此产品符合欧盟 RoHS 指令的要求；
按照中国的相关法规和标准，不含有毒有害物质或元素。