

KEMET, L-RMS, RF, 470 nH, 5%

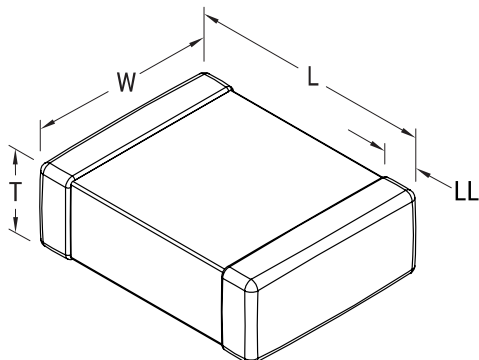

Dimensions	
Chip Size	0603
L	1.6mm +/-0.15mm
W	0.8mm +/-0.15mm
T	0.8mm +/-0.15mm
LL	0.3mm +/-0.2mm

Packaging Specifications	
Packaging:	T&R
Packaging Quantity:	4000

General Information	
Series:	L-RMS
Style:	SMD Chip
Description:	Surface Mount Inductor
RoHS:	Yes
Core:	Ceramic
Winding Type:	Multilayer

Specifications	
Inductance:	0.47 uH (50 MHz)
Inductance Tolerance:	5%
Temperature Range:	-40/+85°C
Current:	150 mAmps (MAX)
DC Resistance:	2.6 Ohms
Quality Factor:	13 at 100 MHz
Self-Resonant Frequency:	300 MHz