

Phase-sequence Phase-loss Relay

K8DS-PH

Three-phase Phase-sequence Phase-loss Relay Using Voltage Detection Method



- Lineup includes a 17.5-mm slim, compact model. **NEW**
- Greater resistance to inverter noise. **NEW**
- Distinguishes between positive phases, reversed phases, and phase loss when power is turned ON.
- Supports phase loss detection when the motor is operating.
- Output status can be monitored using LED indicator.
- Ideal to prevent reverse operation of motors.



Refer to *Safety Precautions for the K8AK Series* on page 86.
Refer to page 44 for commonly asked questions.

For the most recent information on models that have been certified for safety standards, refer to your OMRON website.

Ordering Information

List of Models

Function	Rated input voltage*	Relay output	Model
Phase sequence and phase loss monitoring	3-phase, 3-wire 200 to 480 VAC	SPDT × 1	K8DS-PH1

* The power supply is shared with the rated input voltage.

K8DS-PH

Ratings and Specifications

Ratings

Rated input voltage	3-phase, 200 to 480 VAC (3-wire)
Input load	Approx. 2.7 VA
Reversed phase and phase loss operating time	0.1 s max.
Reset method	Automatic reset
Indicators	Power (PWR): Green, Relay output (RY): Yellow
Output relays	One SPDT relay (NC operation)
Output relay ratings	Rated load Resistive load 5 A at 250 VAC 5 A at 30 VDC Max. switching voltage 250 VAC or 30 VDC Max. switching current: 5 A Maximum switching capacity: 1,250 VA, 150 W Mechanical life: 10 million operations min. Electrical life: 5 A at 250 VAC or 30 VDC:50,000 operations 3 A at 250 VAC/30 VDC:100,000 operations
Ambient operating temperature	-20 to 60°C (with no condensation or icing)
Storage temperature	-25 to 65°C (with no condensation or icing)
Ambient operating humidity	25% to 85% (with no condensation)
Storage humidity	25% to 85% (with no condensation)
Altitude	2,000 m max.
Terminal screw tightening torque	0.49 N·m
Terminal wiring method	Recommended wire Solid wire: 2.5 mm ² Twisted wires: AWG16, AWG18 Note: 1. Ferrules with insulating sleeves must be used with twisted wires. 2. Two wires can be twisted together. Recommended ferrules Al 1,5-8BK (for AWG16) manufactured by Phoenix Contact Al 1-8RD (for AWG18) manufactured by Phoenix Contact Al 0,75-8GY (for AWG18) manufactured by Phoenix Contact
Case color	N1.5
Case material	PC and ABS
Weight	Approx. 60 g
Mounting	Mounts to DIN Track.
Dimensions	17.5 × 80 × 73 mm (W×D×H)

Specifications

Input voltage range		200 to 480 VAC
Input frequency		50/60 Hz (no presumed range)
Overload capacity		Continuous 500 V
Applicable standards	Conforming standards	EN60947-5-1 Installation environment (pollution level 2, installation category III)
	EMC	EN60947-5-1
	Safety standards	UL 508 (Recognition), Korean Radio Waves Act (Act 10564), CSA: CAN/CSA C22.2 No.14, CCC: GB14048.5
Insulation resistance		20 M Ω min. Between external terminals and case Between input terminals and output terminals
Dielectric strength		2,000 VAC for one minute Between external terminals and case Between input terminals and output terminals
Noise immunity		1,500 V power supply terminal common/normal mode Square-wave noise of $\pm 1 \mu\text{s}/100 \text{ ns}$ pulse width with 1-ns rise time
Vibration resistance		Frequency: 10 to 55 Hz, acceleration 50 m/s ² 10 sweeps of 5 min each in X,Y, and Z directions
Shock resistance		150 m/s ² , 3 times each in 6 directions along 3 axes However, 100 m/s ² for relay contacts.
Degree of protection		Terminals: IP20

●Relationship of Mounting Distance between K8DS-PH Relays and Ambient Temperature (Reference Values)

The following diagram shows the relationship between the mounting distances and the ambient temperature.

If the relay is used with an ambient temperature that exceeds these values, the temperature of the K8DS may rise and shorten the life of the internal components.

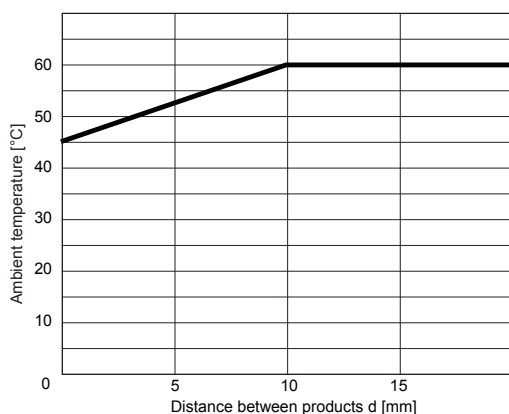

Test method

Sample: K8DS-PH

Mounting distances: 0, 5, and 10 mm min.

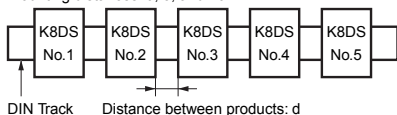

Connections

Wiring Diagram

●Phase Sequence and Phase Loss Operation Diagram

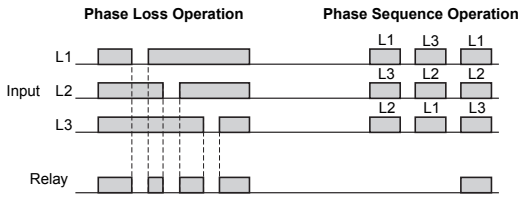

- Note:**
1. The K8DS-PH1 output contacts are normally operative.
 2. The Relay will not operate if the input voltage drops below 70% of the minimum input value because L1 and L2 are also used to provide power.
 3. Phase loss cannot be detected on the load side because this detection is based on the voltage.

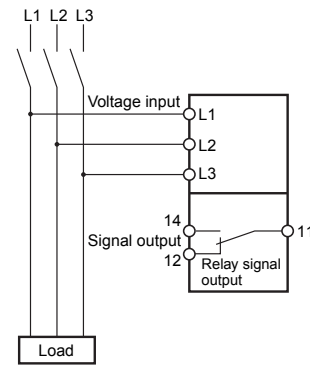

Nomenclature

Front

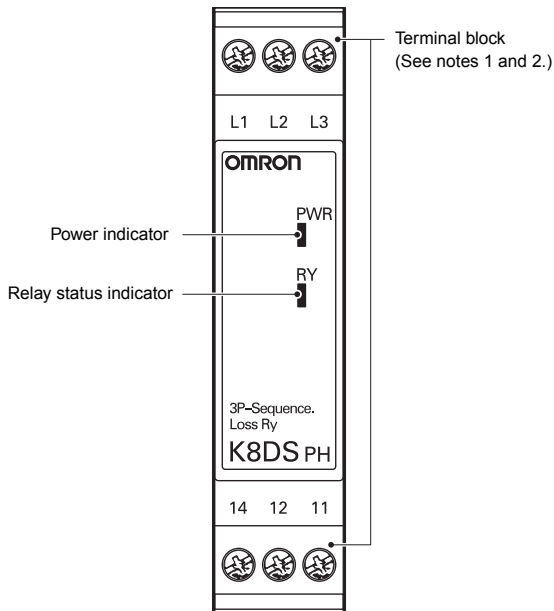

●Indicators

Item	Meaning
Power indicator (PWR: Green)	Lit when power is being supplied *3.
Relay status indicator (RY: Yellow)	Lit when relay is operating (normally lit).

* The input across L1 and L2 is used for the internal power supply. Therefore, the power indicator will not be lit if there is no input across L1 and L2.

Note: 1. Use either a solid wire of 2.5 mm² maximum or a ferrule with insulating sleeve for the terminal connection. The length of the exposed current-carrying part inserted into the terminal must be 8 mm or less to maintain dielectric strength after connection.

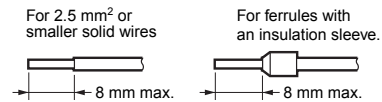

Recommended ferrules
Phoenix Contact

- Al 1,5-8BK (for AWG16)
- Al 1-8RD (for AWG18)
- Al 0,75-8GY (for AWG18)

2. Tightening torque: 0.49 N·m

Operation and Setting Methods

●Connections

1. Input
Connect using L1, L2, and L3.
Make sure the phase sequence is wired correctly. The Unit will not operate normally if the phase sequence is incorrect.
 2. Outputs
Terminals 11, 12, and 14 are the output terminals SPDT.
- * Use the recommended ferrules if you use twisted wires.

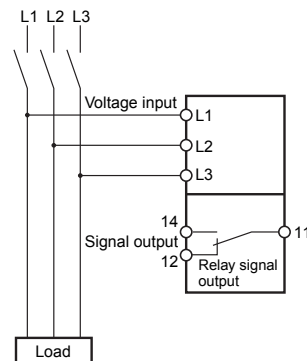

Dimensions

(Unit: mm)

●Phase-sequence Phase-loss Relay

K8DS-PH1

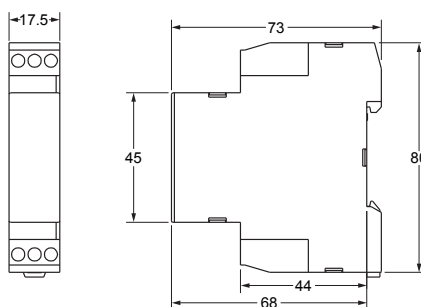

Optional Parts for DIN Track Mounting

●DIN Tracks

PFP-100N

PFP-50N

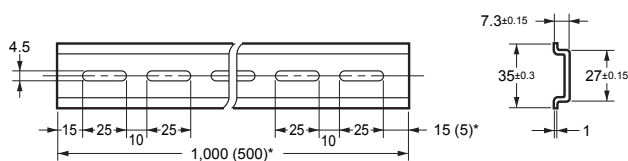
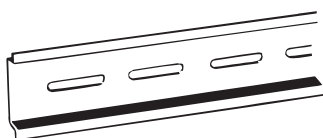

*Dimensions in parentheses are for the PFP-50N.

Questions and Answers

Q Checking Operation

A Phase Sequence
Switch the wiring, as shown by the dotted lines in the connection diagram, to reverse the phase sequence and check that the K8DS operates.

Phase Loss
Create a phase loss for any input phase and check that the K8AK operates.

Connection Diagram

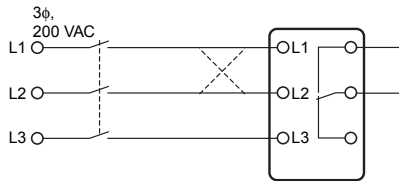

Q Can phase loss be detected on the load side?

A In principle, phase loss cannot be detected on the load side because the K8DS-PH measures three-phase voltage to determine phase loss.

Q Is it possible to detect phase losses for motor loads while the motor is operating?

A Phase loss can be detected while the motor is operating. However, the detection conditions depend on the load conditions that are shown in the following figure. Understand these characteristics when using this feature.

Normally, three-phase motors will continue to rotate even if one phase is open. The three-phase voltage will be induced at the motor terminals. The diagram shows voltage induction at the motor terminals when phase R has been lost with a load applied to a three-phase motor. The horizontal axis shows the motor load as a percentage of the rated load, and the vertical axis shows voltage as a percentage of the rated voltage. The solid line in the this graph shows the voltage that is induced at the motor terminals when a phase loss occurs while the motor is operating under various loads. The figure below shows how a phase loss that occurs while the motor is operating causes an imbalance in the voltage across each motor terminal. The K8DS-PH1 detects phase loss when the motor is operating when the voltage is unbalanced. (Detection occurs when the imbalance is 80% of the maximum phase). The K8DS-PH1 cannot detect phase loss with light motor loads because the voltage imbalance is too small. The detectable range is shown by the diagonal lines.

Characteristic Curve Diagram

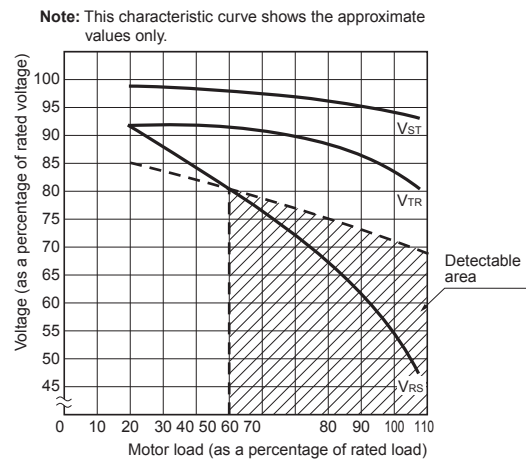

Note: For phase loss of phase R. V_{st}, V_{tr}, and V_{rs} indicate the motor terminal voltage at phase loss.





Safety Precautions

Be sure to read the precautions for all models in the website at the following URL: <http://www.ia.omron.com/>.

Warning Indications

 CAUTION	Indicates a potentially hazardous situation which, if not avoided, may result in minor or moderate injury or in property damage.
Precautions for Safe Use	Supplementary comments on what to do or avoid doing, to use the product safely.
Precautions for Correct Use	Supplementary comments on what to do or avoid doing, to prevent failure to operate, malfunction, or undesirable effects on product performance.

Meaning of Product Safety Symbols

	Used to warn of the risk of electric shock under specific conditions.
	Used for general prohibitions for which there is no specific symbol.
	Used to indicate prohibition when there is a risk of minor injury from electrical shock or other source if the product is disassembled.
	Used for general mandatory action precautions for which there is no specified symbol.

CAUTION

Electrical shock may cause minor injury.
Do not touch terminals while electricity is being supplied.



There is a risk of minor electrical shock, fire, or device failure.
Do not allow any pieces of metal, conductors, or cutting chips that occur during the installation process to enter the product.



Explosions may cause minor injuries. Do not use the product in locations with inflammable or explosive gases.



There is a risk of minor electrical shock, fire, or device failure.
Do not disassemble, modify, repair, or touch the inside of the product.



Loose screws may cause fires. Tighten terminal screws to the specified torque of 0.49 to 0.59 N·m.



Use of excessive torque may damage the terminal screws.
Tighten terminal screws to the specified torque of 0.49 to 0.59 N·m.



If the setting does not match the element to be monitored, the product may behave unexpectedly and damage the machine or cause accidents. Set the K8AK-TH as described below.



- Adjust each set value on the K8AK-TH correctly for the element that is to be monitored.
- Turn OFF the power to the K8AK-TH before you change the switch settings on the side panel. The switch settings made on the side panel take effect when the power is turned ON.

If the K8AK-TH fails, the monitoring alarms and alarm outputs may fail to operate. This may result in physical damage to the facilities, equipment, or other devices that are connected to it. To reduce this risk, inspect the product regularly. To make the product fail-safe, take alternative safety measures, such as the installation of monitoring devices on a separate circuit.



Use of the product beyond its life may result in contact welding or burning. Make sure to consider the actual operating conditions and use the product within its rated load and electrical life count. The life of the output relay varies significantly with the switching capacity and switching conditions.



Precautions for Safe Use

- Do not use or store the product in the following locations.
 - Locations subject to water or oil
 - Locations subject to direct radiant heat from heating equipment
 - Outdoor locations or under direct sunlight
 - Locations subject to dust or corrosive gases (particularly sulfurizing gases, ammonia, etc.)
 - Locations subject to rapid temperature changes
 - Locations prone to icing and dew condensation
 - Locations subject to excessive vibration or shock
 - Locations subject to wind and rain
 - Locations subject to static electricity and noise
 - Habitats of insects or small animals
- Use and store the product in a location where the ambient temperature and humidity are within the specified ranges. If applicable, provide forced cooling.
- Mount the product in the correct direction.
- Check terminal polarity when wiring and wire all connections correctly. The power supply terminals do not have polarity.
- Do not wire the input and output terminals incorrectly.
- Make sure the power supply voltage and loads are within the specifications and ratings for the product.
- Make sure the type of the thermocouple matches the input type that the K8AK-TH is designed for.
- If you need to extend the length of the lead wires on the thermocouple to use with the K8AK-TH, make sure to match the type of thermocouple and always use compensating conductors.
- To extend the lead wires on the platinum resistance thermometer that is used with the K8AK-TH, use lead wires with a low resistance (5 Ω or less per wire), and make the resistance equal on all three lead wires.
- Make sure the crimp terminals for wiring are of the specified size.
- Do not connect anything to terminals that are not being used.
- Use a power supply that will reach the rated voltage within 1 second after the power is turned ON.
- After you turn ON the power, it takes 2 seconds for the outputs of the K8AK-TH to stabilize. Take this time into account when you design the control panel.
- Allow at least 30 minutes for the K8AK-TH to warm up. During this time, the temperature measurements will be incorrect.
- Keep wiring separate from high voltages and power lines that draw large currents.
Do not place product wiring in parallel with or in the same path as high-voltage or high-current lines.
- Do not install the product near equipment that generates high frequencies or surges.
- The product may cause incoming radio wave interference. Do not use the product near radio wave receivers.
- Install an external switch or circuit breaker and label it clearly so that the operator can quickly turn OFF the power supply.

19. When cleaning the product, do not use thinners or solvents. Use commercial alcohol.
20. Make sure the power and output indicators operate correctly. Depending on the application environment, the indicators and other plastic parts may wear prematurely and become difficult to see. Check and replace these parts regularly.
21. The terminal blocks may heat up to 65°C. Use care when handling them.
22. Do not use the product if it is accidentally dropped. The internal components may be damaged.
23. Be sure you understand the contents of this catalog and handle the product according to the instructions provided.
24. Do not install the product in any way that would place a load on it.
25. When discarding the product, properly dispose of it as industrial waste.
26. When using the product, remember that the power supply terminals carry a high voltage.
27. The product must be handled only by trained electrician.
28. Prior to operation, check the wiring before you supply power to the product.
29. Do not install the product immediately next to heat sources.

Precautions for Correct Use

Observe the following operating methods to prevent failure and malfunction.

1. Use operating power, input power, and other power supplies and converters with suitable capacities and rated outputs.
2. Allow only qualified personnel to manage or handle the product.
3. Use a precision screwdriver or similar tool to adjust the setting knobs.
4. The distortion in the input waveform for the K8AK-AS, K8AK-AW, K8AK-PH, K8AK-PA, K8AK-PM, or K8DS-PH must be 30% max. If the input waveform is distorted beyond this level, it may cause unnecessary operation.
Do not use the K8AK-VS or K8AK-VW in circuits with waveform distortion. Error will be large due to waveform distortion.
5. Error will be large if the K8AK-AS, K8AK-AW, K8AK-VS, or K8AK-VW is used for thyristor or inverter control. The K8AK-PH, K8AK-PA, K8AK-PM, K8AK-PW, or K8DS-PH cannot be used on the secondary side of an inverter. To use the product on the load side of an inverter, install a noise filter on the primary side of the inverter.
6. To reduce the error in the setting knob, always turn the setting knob from the minimum setting toward the maximum setting.
7. Phase loss is detected for the K8AK-PA or K8AK-PM only when the phase loss occurs between the input contacts and the power supply. Phase loss is not detected on the load side.
8. Phase loss can be detected only from the input contacts to the power supply side by the K8AK-PH, K8AK-PA, K8AK-PM, or K8DS-PH. Phase loss cannot be detected from the input contacts to the load side.

Mounting and Removing the K8AK

- Mounting to DIN Track
 1. Catch the upper hook on the DIN Track.
 2. Push the product onto the Track until the hooks lock into place.

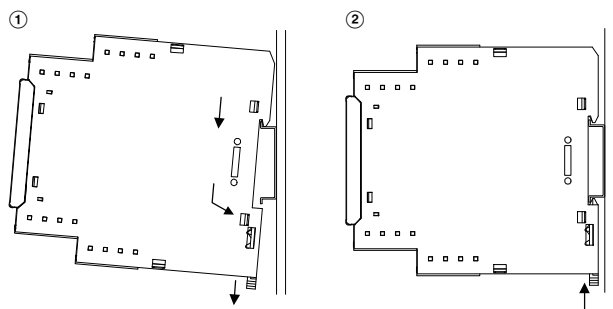

- To remove the product, pull down on the bottom hook with a flat-blade screwdriver and lift up on the product.

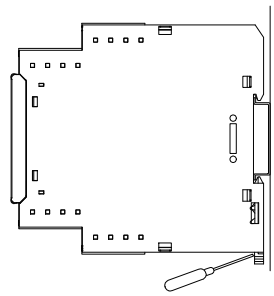

Applicable DIN Tracks:
PFP-100N (100 cm)
PFP-50N (50 cm)

Mounting and Removing the K8DS

- The product may be mounted in any direction, but it must be mounted securely and as level as possible.
- To mount the product to the DIN Track, hook it on the DIN Track at (A) and then press in on the Unit in direction (B).

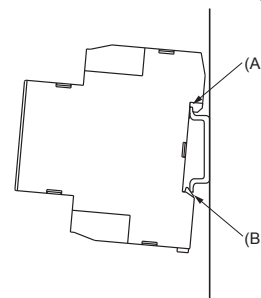

- To remove the product, insert a flat-blade screwdriver at (C) and pull down the hook to release the Unit.

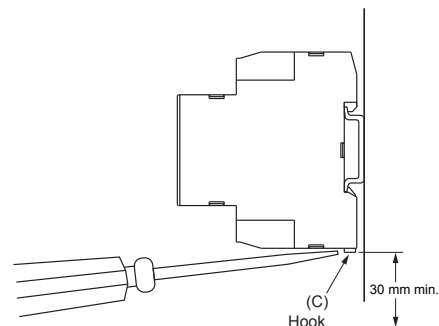

- Leave at least 30 mm of space between the product and other devices to allow easy installation and removal.

Adjusting the Setting Knobs

- Use a screwdriver to adjust the setting knobs. The knobs have a stopper that prevents them from turning beyond the full right or left position. Do not force a knob beyond these points.

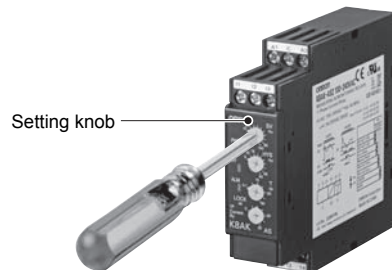

* (Not applicable to the K8AK-PH and K8DS-PH.)

Terms and Conditions of Sale

1. **Offer; Acceptance.** These terms and conditions (these "**Terms**") are deemed part of all quotes, agreements, purchase orders, acknowledgments, price lists, catalogs, manuals, brochures and other documents, whether electronic or in writing, relating to the sale of products or services (collectively, the "**Products**") by Omron Electronics LLC and its subsidiary companies ("**Omron**"). Omron objects to any terms or conditions proposed in Buyer's purchase order or other documents which are inconsistent with, or in addition to, these Terms.
2. **Prices; Payment Terms.** All prices stated are current, subject to change without notice by Omron. Omron reserves the right to increase or decrease prices on any unshipped portions of outstanding orders. Payments for Products are due net 30 days unless otherwise stated in the invoice.
3. **Discounts.** Cash discounts, if any, will apply only on the net amount of invoices sent to Buyer after deducting transportation charges, taxes and duties, and will be allowed only if (i) the invoice is paid according to Omron's payment terms and (ii) Buyer has no past due amounts.
4. **Interest.** Omron, at its option, may charge Buyer 1-1/2% interest per month or the maximum legal rate, whichever is less, on any balance not paid within the stated terms.
5. **Orders.** Omron will accept no order less than \$200 net billing.
6. **Governmental Approvals.** Buyer shall be responsible for, and shall bear all costs involved in, obtaining any government approvals required for the importation or sale of the Products.
7. **Taxes.** All taxes, duties and other governmental charges (other than general real property and income taxes), including any interest or penalties thereon, imposed directly or indirectly on Omron or required to be collected directly or indirectly by Omron for the manufacture, production, sale, delivery, importation, consumption or use of the Products sold hereunder (including customs duties and sales, excise, use, turnover and license taxes) shall be charged to and remitted by Buyer to Omron.
8. **Financial.** If the financial position of Buyer at any time becomes unsatisfactory to Omron, Omron reserves the right to stop shipments or require satisfactory security or payment in advance. If Buyer fails to make payment or otherwise comply with these Terms or any related agreement, Omron may (without liability and in addition to other remedies) cancel any unshipped portion of Products sold hereunder and stop any Products in transit until Buyer pays all amounts, including amounts payable hereunder, whether or not then due, which are owing to it by Buyer. Buyer shall in any event remain liable for all unpaid accounts.
9. **Cancellation; Etc.** Orders are not subject to rescheduling or cancellation unless Buyer indemnifies Omron against all related costs or expenses.
10. **Force Majeure.** Omron shall not be liable for any delay or failure in delivery resulting from causes beyond its control, including earthquakes, fires, floods, strikes or other labor disputes, shortage of labor or materials, accidents to machinery, acts of sabotage, riots, delay in or lack of transportation or the requirements of any government authority.
11. **Shipping; Delivery.** Unless otherwise expressly agreed in writing by Omron:
 - a. Shipments shall be by a carrier selected by Omron; Omron will not drop ship except in "break down" situations.
 - b. Such carrier shall act as the agent of Buyer and delivery to such carrier shall constitute delivery to Buyer;
 - c. All sales and shipments of Products shall be FOB shipping point (unless otherwise stated in writing by Omron), at which point title and risk of loss shall pass from Omron to Buyer; provided that Omron shall retain a security interest in the Products until the full purchase price is paid;
 - d. Delivery and shipping dates are estimates only; and
 - e. Omron will package Products as it deems proper for protection against normal handling and extra charges apply to special conditions.
12. **Claims.** Any claim by Buyer against Omron for shortage or damage to the Products occurring before delivery to the carrier must be presented in writing to Omron within 30 days of receipt of shipment and include the original transportation bill signed by the carrier noting that the carrier received the Products from Omron in the condition claimed.
13. **Warranties.** (a) **Exclusive Warranty.** Omron's exclusive warranty is that the Products will be free from defects in materials and workmanship for a period of twelve months from the date of sale by Omron (or such other period expressed in writing by Omron). Omron disclaims all other warranties, express or implied. (b) **Limitations.** OMRON MAKES NO WARRANTY OR REPRESENTATION, EXPRESS OR IMPLIED, ABOUT NON-INFRINGEMENT, MERCHANTABILITY OR FITNESS FOR A PARTICULAR PURPOSE OF THE PRODUCTS. BUYER ACKNOWLEDGES THAT IT ALONE HAS DETERMINED THAT THE PRODUCTS WILL SUITABLY MEET THE REQUIREMENTS OF THEIR INTENDED USE. Omron further disclaims all warranties and responsibility of any type for claims or expenses based on infringement by the Products or otherwise of any intellectual property right. (c) **Buyer Remedy.** Omron's sole obligation hereunder shall be, at Omron's election, to (i) replace (in the form originally shipped with Buyer responsible for labor charges for removal or replacement thereof) the non-complying Product, (ii) repair the non-complying Product, or (iii) repay or credit Buyer an amount equal to the purchase price of the non-complying Product; provided that in no event shall Omron be responsible for warranty, repair, indemnity or any other claims or expenses regarding the Products unless Omron's analysis confirms that the Products were properly handled, stored, installed and maintained and not subject to contamination, abuse, misuse or inappropriate modification. Return of any Products by Buyer must be approved in writing by Omron before shipment. Omron Companies shall not be liable for the suitability or unsuitability or the results from the use of Products in combination with any electrical or electronic components, circuits, system assemblies or any other materials or substances or environments. Any advice, recommendations or information given orally or in writing, are not to be construed as an amendment or addition to the above warranty. See <http://www.omron247.com> or contact your Omron representative for published information.
14. **Limitation on Liability; Etc.** OMRON COMPANIES SHALL NOT BE LIABLE FOR SPECIAL, INDIRECT, INCIDENTAL, OR CONSEQUENTIAL DAMAGES, LOSS OF PROFITS OR PRODUCTION OR COMMERCIAL LOSS IN ANY WAY CONNECTED WITH THE PRODUCTS, WHETHER SUCH CLAIM IS BASED IN CONTRACT, WARRANTY, NEGLIGENCE OR STRICT LIABILITY. Further, in no event shall liability of Omron Companies exceed the individual price of the Product on which liability is asserted.
15. **Indemnities.** Buyer shall indemnify and hold harmless Omron Companies and their employees from and against all liabilities, losses, claims, costs and expenses (including attorney's fees and expenses) related to any claim, investigation, litigation or proceeding (whether or not Omron is a party) which arises or is alleged to arise from Buyer's acts or omissions under these Terms or in any way with respect to the Products. Without limiting the foregoing, Buyer (at its own expense) shall indemnify and hold harmless Omron and defend or settle any action brought against such Companies to the extent based on a claim that any Product made to Buyer specifications infringed intellectual property rights of another party.
16. **Property; Confidentiality.** Any intellectual property in the Products is the exclusive property of Omron Companies and Buyer shall not attempt to duplicate it in any way without the written permission of Omron. Notwithstanding any charges to Buyer for engineering or tooling, all engineering and tooling shall remain the exclusive property of Omron. All information and materials supplied by Omron to Buyer relating to the Products are confidential and proprietary, and Buyer shall limit distribution thereof to its trusted employees and strictly prevent disclosure to any third party.
17. **Export Controls.** Buyer shall comply with all applicable laws, regulations and licenses regarding (i) export of products or information; (ii) sale of products to "forbidden" or other proscribed persons; and (iii) disclosure to non-citizens of regulated technology or information.
18. **Miscellaneous.** (a) **Waiver.** No failure or delay by Omron in exercising any right and no course of dealing between Buyer and Omron shall operate as a waiver of rights by Omron. (b) **Assignment.** Buyer may not assign its rights hereunder without Omron's written consent. (c) **Law.** These Terms are governed by the law of the jurisdiction of the home office of the Omron company from which Buyer is purchasing the Products (without regard to conflict of law principles). (d) **Amendment.** These Terms constitute the entire agreement between Buyer and Omron relating to the Products, and no provision may be changed or waived unless in writing signed by the parties. (e) **Severability.** If any provision hereof is rendered ineffective or invalid, such provision shall not invalidate any other provision. (f) **Setoff.** Buyer shall have no right to set off any amounts against the amount owing in respect of this invoice. (g) **Definitions.** As used herein, "including" means "including without limitation"; and "Omron Companies" (or similar words) mean Omron Corporation and any direct or indirect subsidiary or affiliate thereof.

Certain Precautions on Specifications and Use

1. **Suitability of Use.** Omron Companies shall not be responsible for conformity with any standards, codes or regulations which apply to the combination of the Product in the Buyer's application or use of the Product. At Buyer's request, Omron will provide applicable third party certification documents identifying ratings and limitations of use which apply to the Product. This information by itself is not sufficient for a complete determination of the suitability of the Product in combination with the end product, machine, system, or other application or use. Buyer shall be solely responsible for determining appropriateness of the particular Product with respect to Buyer's application, product or system. Buyer shall take application responsibility in all cases but the following is a non-exhaustive list of applications for which particular attention must be given: (i) Outdoor use, uses involving potential chemical contamination or electrical interference, or conditions or uses not described in this document. (ii) Use in consumer products or any use in significant quantities. (iii) Energy control systems, combustion systems, railroad systems, aviation systems, medical equipment, amusement machines, vehicles, safety equipment, and installations subject to separate industry or government regulations. (iv) Systems, machines and equipment that could present a risk to life or property. Please know and observe all prohibitions of use applicable to this Product. NEVER USE THE PRODUCT FOR AN APPLICATION INVOLVING SERIOUS RISK TO LIFE OR PROPERTY OR IN LARGE QUANTITIES WITHOUT ENSURING THAT THE SYSTEM AS A WHOLE HAS BEEN DESIGNED TO ADDRESS THE RISKS, AND THAT THE OMRON'S PRODUCT IS PROPERLY RATED AND INSTALLED FOR THE INTENDED USE WITHIN THE OVERALL EQUIPMENT OR SYSTEM.
2. **Programmable Products.** Omron Companies shall not be responsible for the user's programming of a programmable Product, or any consequence thereof.
3. **Performance Data.** Data presented in Omron Company websites, catalogs and other materials is provided as a guide for the user in determining suitability and does not constitute a warranty. It may represent the result of Omron's test conditions, and the user must correlate it to actual application requirements. Actual performance is subject to the Omron's Warranty and Limitations of Liability.
4. **Change in Specifications.** Product specifications and accessories may be changed at any time based on improvements and other reasons. It is our practice to change part numbers when published ratings or features are changed, or when significant construction changes are made. However, some specifications of the Product may be changed without any notice. When in doubt, special part numbers may be assigned to fix or establish key specifications for your application. Please consult with your Omron's representative at any time to confirm actual specifications of purchased Product.
5. **Errors and Omissions.** Information presented by Omron Companies has been checked and is believed to be accurate; however, no responsibility is assumed for clerical, typographical or proofreading errors or omissions.

OMRON INDUSTRIAL AUTOMATION • THE AMERICAS HEADQUARTERS

Schaumburg, IL USA • 847.843.7900 • 800.556.6766 • www.omron247.com

OMRON CANADA, INC. • HEAD OFFICE

Toronto, ON, Canada • 416.286.6465 • 866.986.6766 • www.omron247.com

OMRON ELECTRONICS DE MEXICO • HEAD OFFICE

México DF • 52.55.59.01.43.00 • 001.800.556.6766 • mela@omron.com

OMRON ELECTRONICS DE MEXICO • SALES OFFICE

Apodaca, N.L. • 52.81.11.56.99.20 • 001.800.556.6766 • mela@omron.com

OMRON ELETRÔNICA DO BRASIL LTDA • HEAD OFFICE

São Paulo, SP, Brasil • 55.11.2101.6300 • www.omron.com.br

OMRON ARGENTINA • SALES OFFICE

Cono Sur • 54.11.4783.5300

OMRON CHILE • SALES OFFICE

Santiago • 56.9.9917.3920

OTHER OMRON LATIN AMERICA SALES

54.11.4783.5300

OMRON EUROPE B.V. • Wegalaan 67-69, NL-2132 JD, Hoofddorp, The Netherlands. • Tel: +31 (0) 23 568 13 00

Fax: +31 (0) 23 568 13 88 • www.industrial.omron.eu