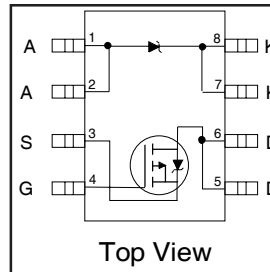


# IRF7342D2PbF

FETKY™ MOSFET & Schottky Diode

- Co-packaged HEXFET® Power MOSFET and Schottky Diode
- Ideal For Buck Regulator Applications
- P-Channel HEXFET®
- Low  $V_F$  Schottky Rectifier
- SO-8 Footprint
- Lead-Free

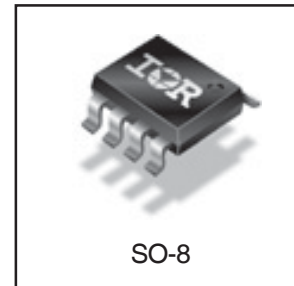


$V_{DSS} = -55V$
$R_{DS(on)} = 105m\Omega$
Schottky $V_f = 0.61V$

## Description

The FETKY™ family of Co-packaged HEXFETs and Schottky diodes offer the designer an innovative board space saving solution for switching regulator and power management applications. HEXFETs utilize advanced processing techniques to achieve extremely low on-resistance per silicon area. Combining this technology with International Rectifier's low forward drop Schottky rectifiers results in an extremely efficient device suitable for use in a wide variety of portable electronics applications.

The SO-8 has been modified through a customized leadframe for enhanced thermal characteristics. The SO-8 package is designed for vapor phase, infrared or wave soldering techniques.



## Absolute Maximum Ratings ( $T_A = 25^\circ C$ Unless Otherwise Noted)

Parameter	Maximum	Units
$I_D @ T_A = 25^\circ C$	-3.4	A
$I_D @ T_A = 70^\circ C$	-2.7	
$I_{DM}$	-27	
$P_D @ T_A = 25^\circ C$	2.0	W
$P_D @ T_A = 70^\circ C$	1.3	
	16	mW/°C
$V_{GS}$	$\pm 20$	V
$dv/dt$	-5.0	V/ns
$T_J, T_{STG}$	-55 to +150	°C

## Thermal Resistance

Symbol	Parameter	Typ.	Max.	Units
$R_{\theta JL}$	Junction-to-Drain Lead, MOSFET	—	20	°C/W
$R_{\theta JA}$	Junction-to-Ambient ④, MOSFET	—	62.5	
$R_{\theta JA}$	Junction-to-Ambient ④, SCHOTTKY	—	62.5	

### Notes:

- ① Repetitive rating – pulse width limited by max. junction temperature (see fig. 11)
- ②  $I_{SD} \leq -3.4A$ ,  $di/dt \leq -150A/\mu s$ ,  $V_{DD} \leq V_{(BR)DSS}$ ,  $T_J \leq 150^\circ C$
- ③ Pulse width  $\leq 400\mu s$  – duty cycle  $\leq 2\%$
- ④ Surface mounted on 1 inch square copper board,  $t \leq 10sec$ .

www.irf.com

# IRF7342D2PbF

Electrical Characteristics @ T<sub>J</sub> = 25°C (unless otherwise specified)

International  
IR Rectifier

	Parameter	Min.	Typ.	Max.	Units	Conditions
V <sub>(BR)DSS</sub>	Drain-to-Source Breakdown Voltage	-55	—	—	V	V <sub>GS</sub> = 0V, I <sub>D</sub> = -250μA
ΔV <sub>(BR)DSS</sub> /ΔT <sub>J</sub>	Breakdown Voltage Temp. Coefficient	—	-0.054	—	V/°C	Reference to 25°C, I <sub>D</sub> = -1mA
R <sub>DS(on)</sub>	Static Drain-to-Source On-Resistance	—	95	105	mΩ	V <sub>GS</sub> = -10V, I <sub>D</sub> = -3.4A ③
		—	150	170		V <sub>GS</sub> = -4.5V, I <sub>D</sub> = -2.7A ③
V <sub>GS(th)</sub>	Gate Threshold Voltage	-1.0	—	—	V	V <sub>DS</sub> = V <sub>GS</sub> , I <sub>D</sub> = -250μA
g <sub>fs</sub>	Forward Transconductance	3.3	—	—	S	V <sub>DS</sub> = -10V, I <sub>D</sub> = -3.1A
I <sub>DSS</sub>	Drain-to-Source Leakage Current	—	—	-2.0	μA	V <sub>DS</sub> = -44V, V <sub>GS</sub> = 0V
		—	—	-25		V <sub>DS</sub> = -44V, V <sub>GS</sub> = 0V, T <sub>J</sub> = 70°C
I <sub>GSS</sub>	Gate-to-Source Forward Leakage	—	—	-100	nA	V <sub>GS</sub> = -20V
	Gate-to-Source Reverse Leakage	—	—	100		V <sub>GS</sub> = 20V
Q <sub>g</sub>	Total Gate Charge	—	26	38	nC	I <sub>D</sub> = -3.1A
Q <sub>gs</sub>	Gate-to-Source Charge	—	3.0	4.5		V <sub>DS</sub> = -44V
Q <sub>gd</sub>	Gate-to-Drain ("Miller") Charge	—	8.4	13		V <sub>GS</sub> = -10V, See Fig. 6 & 14 ③
t <sub>d(on)</sub>	Turn-On Delay Time	—	14	22	ns	V <sub>DD</sub> = -28V
t <sub>r</sub>	Rise Time	—	10	15		I <sub>D</sub> = -1.0A
t <sub>d(off)</sub>	Turn-Off Delay Time	—	43	64		R <sub>G</sub> = 6.0Ω
t <sub>f</sub>	Fall Time	—	22	32		V <sub>GS</sub> = -10V, ③
C <sub>iss</sub>	Input Capacitance	—	690	—	pF	V <sub>GS</sub> = 0V
C <sub>oss</sub>	Output Capacitance	—	210	—		V <sub>DS</sub> = -25V
C <sub>rss</sub>	Reverse Transfer Capacitance	—	86	—		f = 1.0MHz, See Fig. 5

## MOSFET Source-Drain Ratings and Characteristics

	Parameter	Min.	Typ.	Max.	Units	Conditions
I <sub>S</sub>	Continuous Source Current (Body Diode)	—	—	-2.0	A	
I <sub>SM</sub>	Pulsed Source Current (Body Diode)	—	—	-27		
V <sub>SD</sub>	Body Diode Forward Voltage	—	—	-1.2	V	T <sub>J</sub> = 25°C, I <sub>S</sub> = -2.0A, V <sub>GS</sub> = 0V
t <sub>rr</sub>	Reverse Recovery Time (Body Diode)	—	54	80	ns	T <sub>J</sub> = 25°C, I <sub>F</sub> = -2.0A
Q <sub>rr</sub>	Reverse Recovery Charge	—	85	130	nC	di/dt = 100A/μs ③

## Schottky Diode Maximum Ratings

	Parameter	Max.	Units	Conditions
I <sub>F(av)</sub>	Max. Average Forward Current	3.0	A	50% Duty Cycle. Rectangular Wave, T <sub>A</sub> = 57°C See Fig. 21
I <sub>SM</sub>	Max. peak one cycle Non-repetitive Surge current	490	A	5μs sine or 3μs Rect. pulse
		70		10ms sine or 6ms Rect. pulse
				Following any rated load condition & with V <sub>rrm</sub> applied

## Schottky Diode Electrical Specifications

	Parameter	Max.	Units	Conditions
V <sub>fm</sub>	Max. Forward Voltage Drop	0.61	V	I <sub>F</sub> = 3.0A, T <sub>J</sub> = 25°C
		0.76		I <sub>F</sub> = 6.0A, T <sub>J</sub> = 25°C
		0.53		I <sub>F</sub> = 3.0A, T <sub>J</sub> = 125°C
		0.65		I <sub>F</sub> = 6.0A, T <sub>J</sub> = 125°C
V <sub>rrm</sub>	Max. Working Peak Reverse Voltage	60	V	
I <sub>rm</sub>	Max. Reverse Leakage Current	2.0	mA	V <sub>r</sub> = 60V, T <sub>J</sub> = 25°C
		30		T <sub>J</sub> = 125°C
C <sub>t</sub>	Max. Junction Capacitance	145	pF	V <sub>r</sub> = 5Vdc ( 100kHz to 1 MHz) 25°C

## Power Mosfet Characteristics

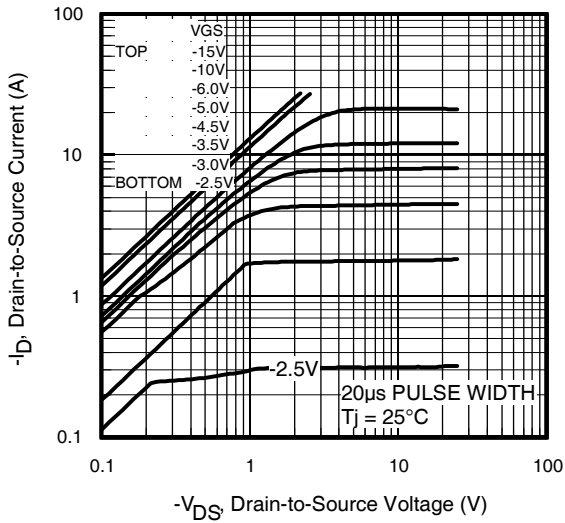


Fig 1. Typical Output Characteristics

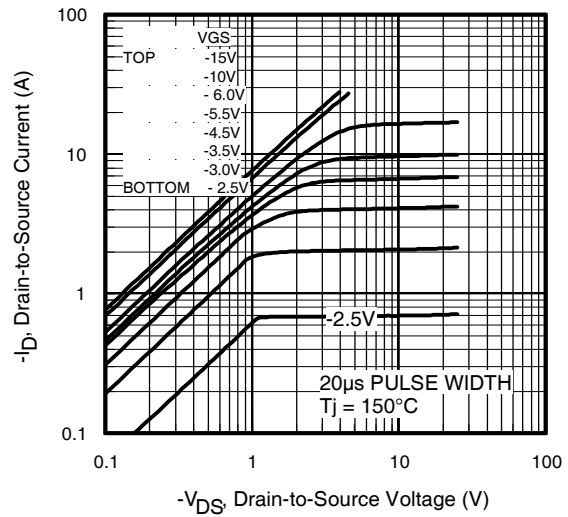


Fig 2. Typical Output Characteristics

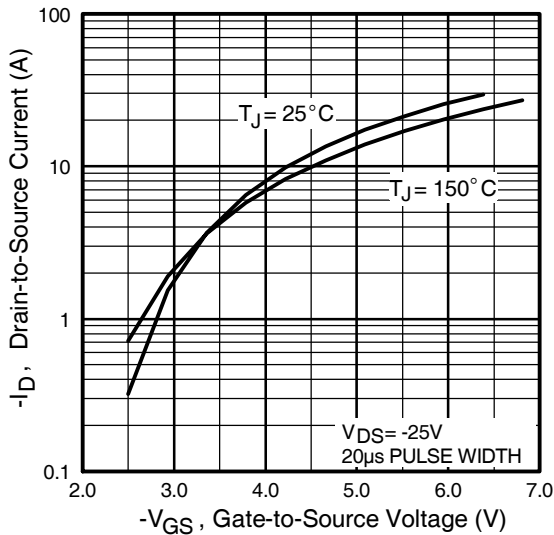


Fig 3. Typical Transfer Characteristics

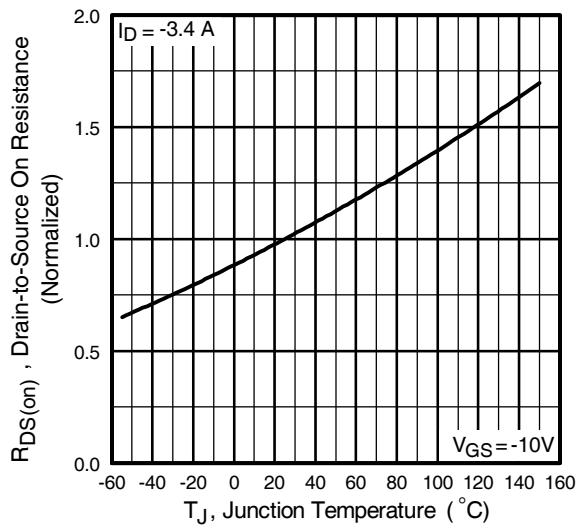
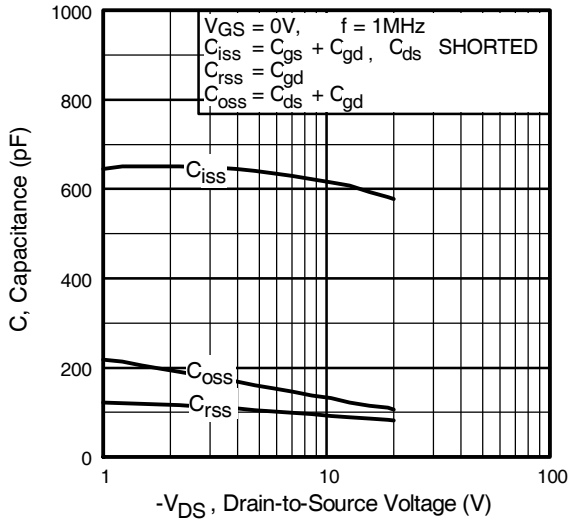


Fig 4. Normalized On-Resistance Vs. Temperature

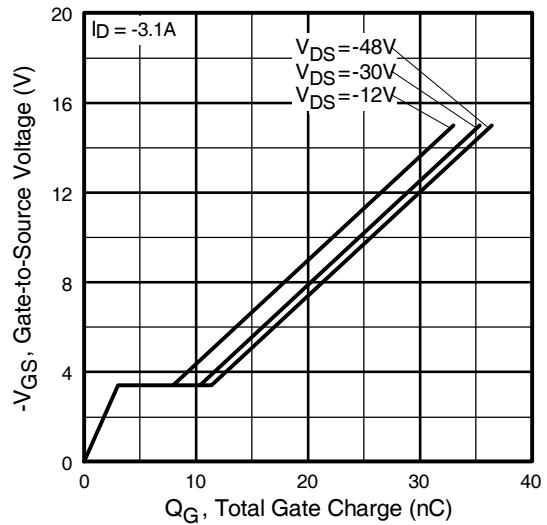
# IRF7342D2PbF

International  
**IR** Rectifier

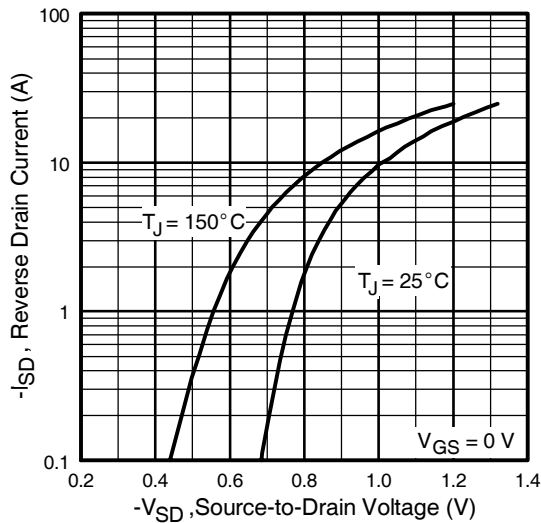
## Power Mosfet Characteristics



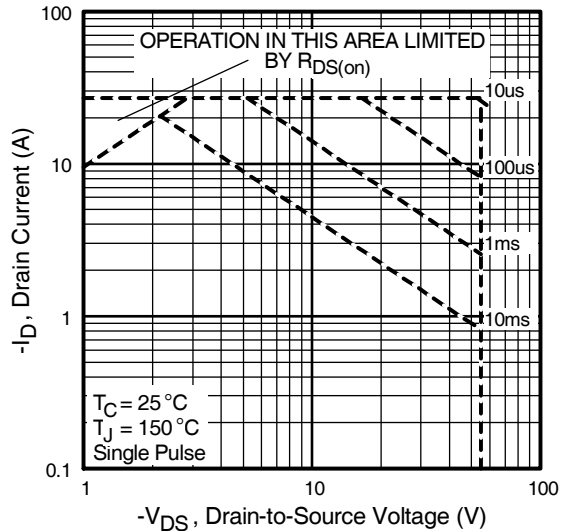
**Fig 5.** Typical Capacitance Vs. Drain-to-Source Voltage



**Fig 6.** Typical Gate Charge Vs. Gate-to-Source Voltage

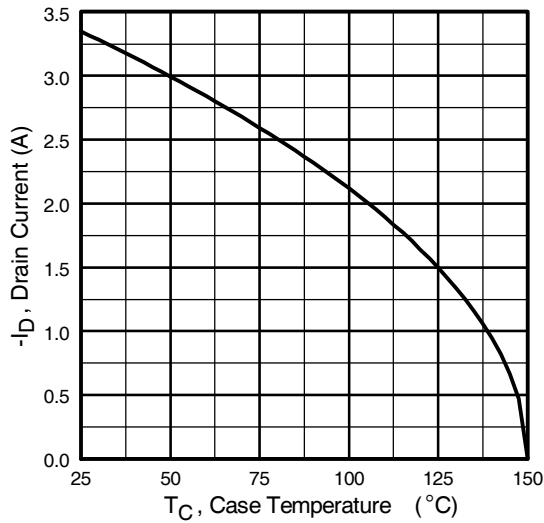


**Fig 7.** Typical Source-Drain Diode Forward Voltage

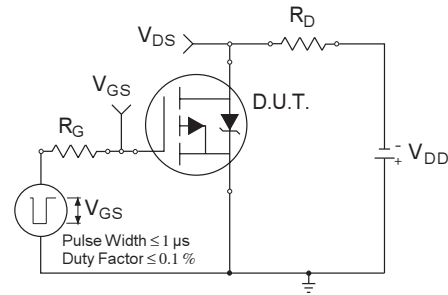


**Fig 8.** Maximum Safe Operating Area

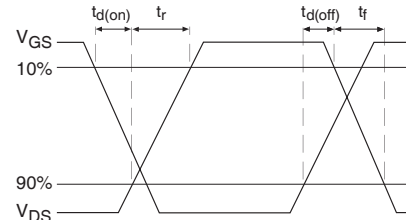
## Power Mosfet Characteristics



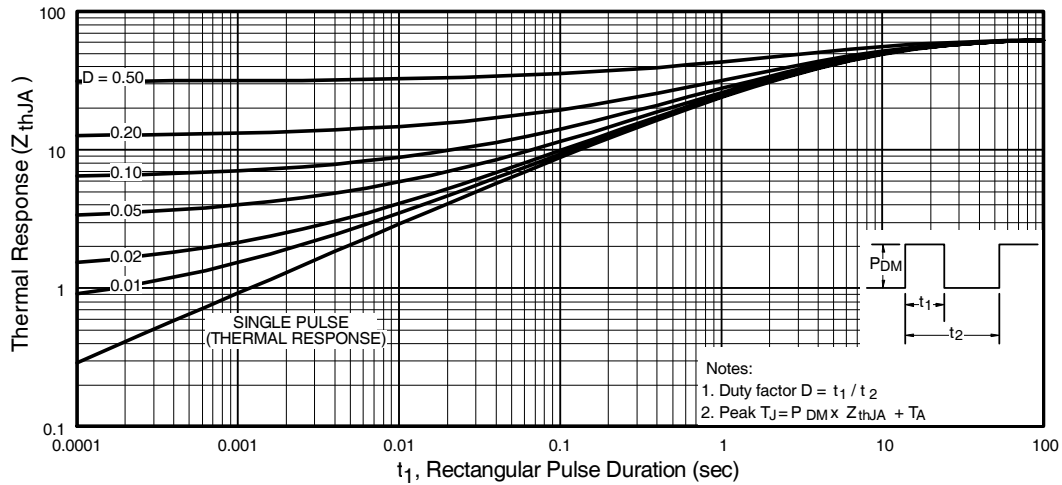
**Fig 9.** Maximum Drain Current Vs. Case Temperature



**Fig 10a.** Switching Time Test Circuit

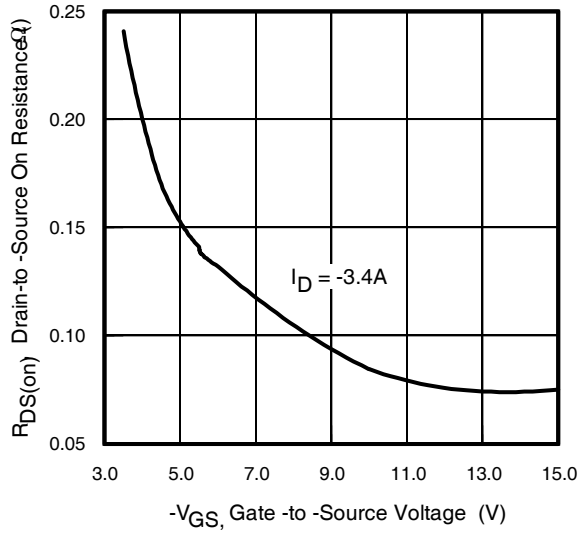


**Fig 10b.** Switching Time Waveforms

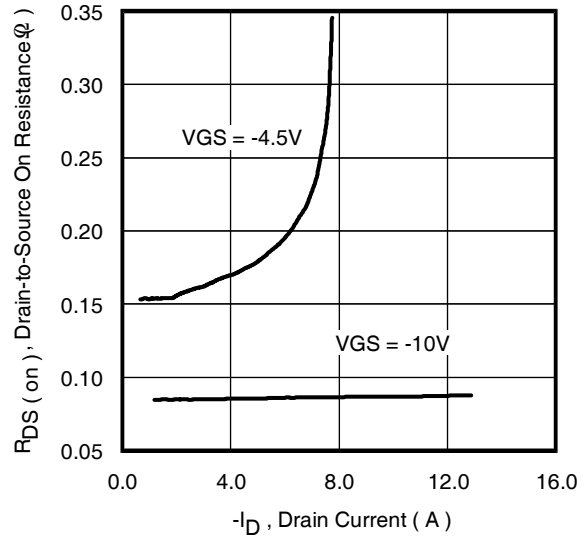


**Fig 11.** Maximum Effective Transient Thermal Impedance, Junction-to-Ambient

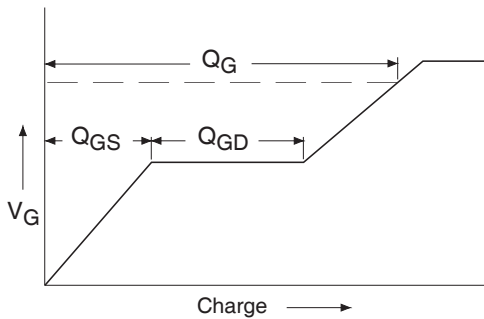
## Power Mosfet Characteristics



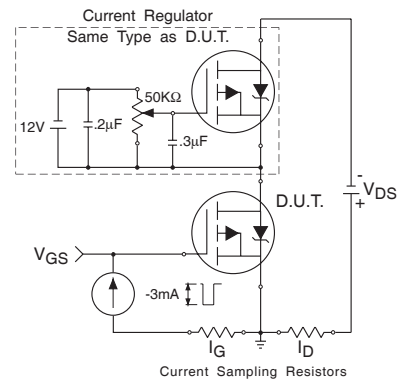
**Fig 12.** Typical On-Resistance Vs. Gate Voltage



**Fig 13.** Typical On-Resistance Vs. Drain Current

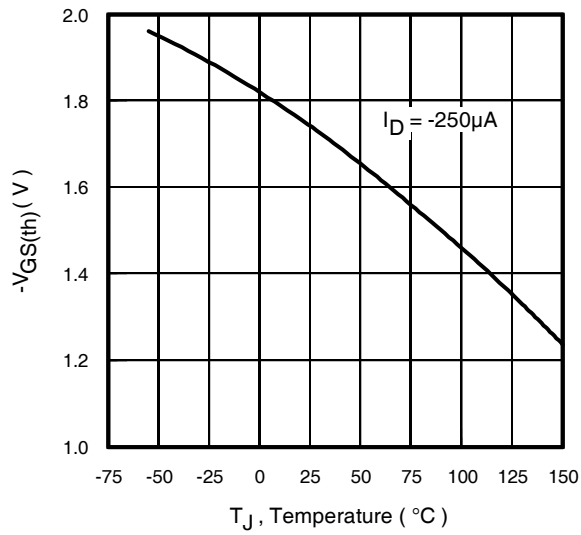


**Fig 14a.** Basic Gate Charge Waveform

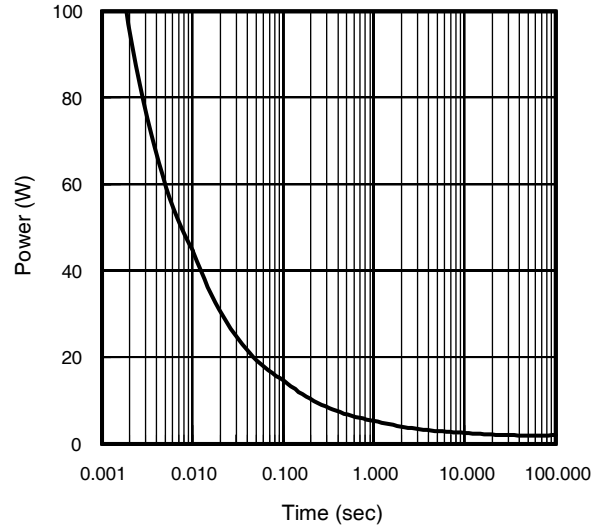


**Fig 14b.** Gate Charge Test Circuit

## Power Mosfet Characteristics

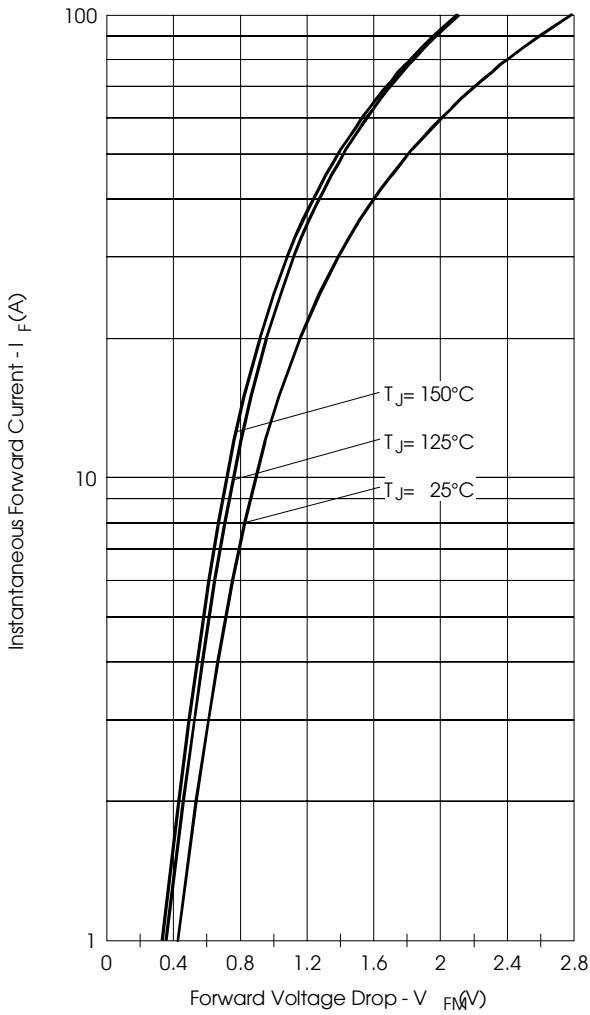


**Fig 15.** Typical  $V_{GS(th)}$  Vs. Junction Temperature

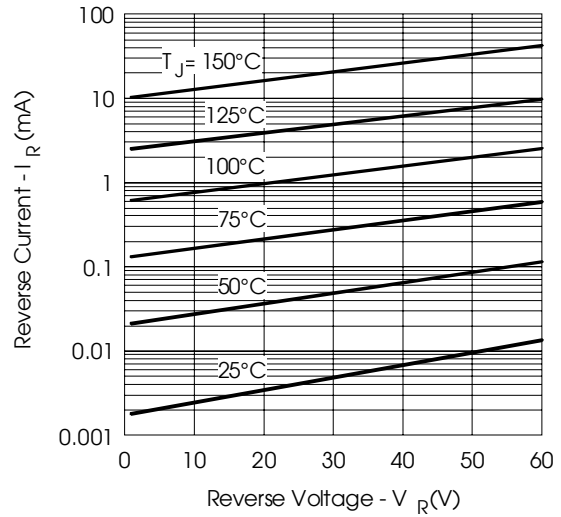


**Fig 16.** Typical Power Vs. Time

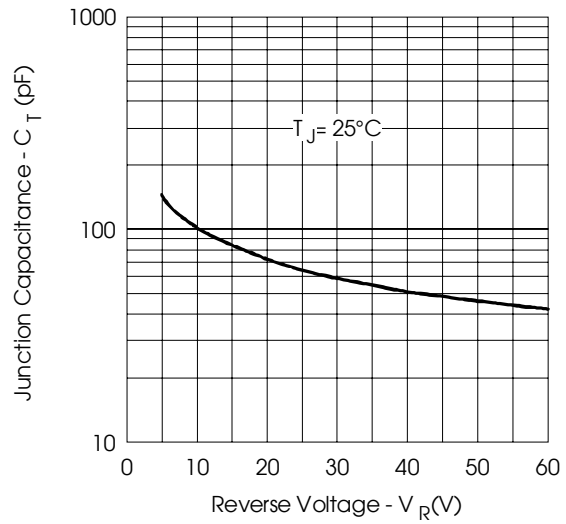
## Schottky Diode Characteristics



**Fig. 17 - Maximum Forward Voltage Drop Characteristics**



**Fig. 18 - Typical Values of Reverse Current Vs. Reverse Voltage**



**Fig. 19 - Typical Junction Capacitance Vs. Reverse Voltage**

## Schottky Diode Characteristics

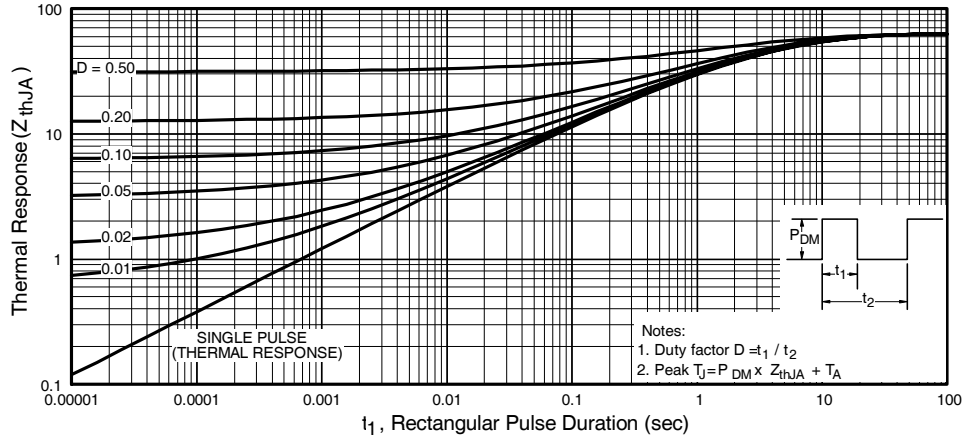


Fig 20. Maximum Effective Transient Thermal Impedance, Junction-to-Ambient

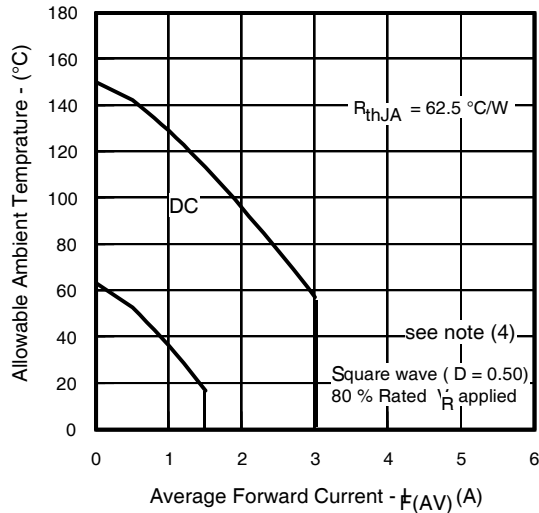
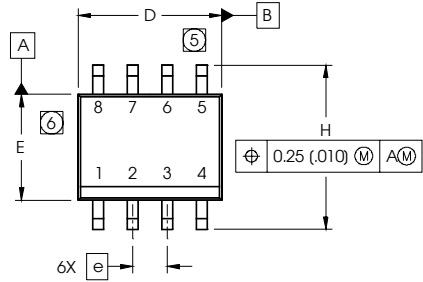


Fig.21 - Maximum Allowable Ambient Temp. Vs. Forward Current

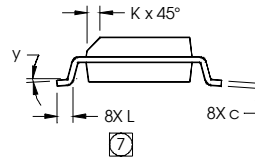
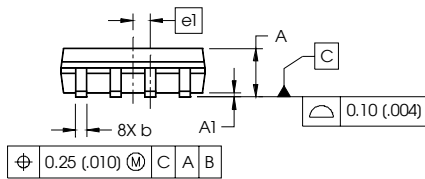
**Note (4)** Formula used:  $T_C = T_J - (P_d + P_{d_{REV}}) \times R_{thJA}$ ;  
 $P_d = \text{Forward Power Loss} = I_{F(AV)} \times V_{FM} @ (I_{F(AV)} / D)$ ;  
 $P_{d_{REV}} = \text{Inverse Power Loss} = V_{R1} \times I_R (1 - D)$ ;  $I_R @ V_{R1} = 80\% \text{ rated } V_R$   
 www.irf.com

# IRF7342D2PbF

## SO-8 (Fetky) Package Outline



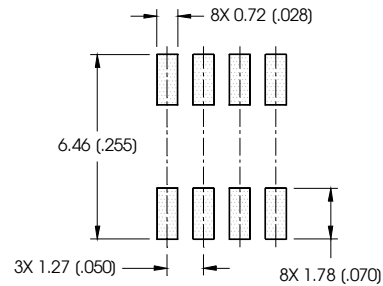
DIM	INCHES		MILLIMETERS	
	MIN	MAX	MIN	MAX
A	.0532	.0688	1.35	1.75
A1	.0040	.0098	0.10	0.25
b	.013	.020	0.33	0.51
c	.0075	.0098	0.19	0.25
D	.189	.1968	4.80	5.00
E	.1497	.1574	3.80	4.00
e	.050 BASIC		1.27 BASIC	
e1	.025 BASIC		0.635 BASIC	
H	.2284	.2440	5.80	6.20
K	.0099	.0196	0.25	0.50
L	.016	.050	0.40	1.27
y	0°	8°	0°	8°



**NOTES:**

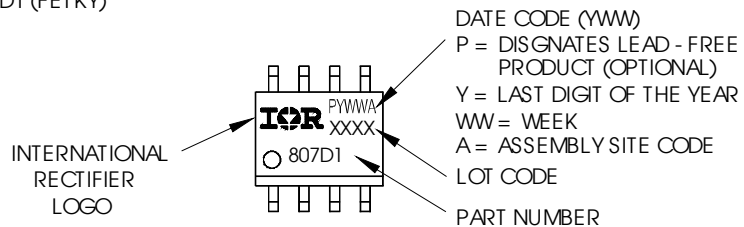
1. DIMENSIONING & TOLERANCING PER ASME Y14.5M-1994.
2. CONTROLLING DIMENSION: MILLIMETER
3. DIMENSIONS ARE SHOWN IN MILLIMETERS (INCHES).
4. OUTLINE CONFORMS TO JEDEC OUTLINE MS-012AA.
- ⑤ DIMENSION DOES NOT INCLUDE MOLD PROTRUSIONS. MOLD PROTRUSIONS NOT TO EXCEED 0.15 (.006).
- ⑥ DIMENSION DOES NOT INCLUDE MOLD PROTRUSIONS. MOLD PROTRUSIONS NOT TO EXCEED 0.25 (.010).
- ⑦ DIMENSION IS THE LENGTH OF LEAD FOR SOLDERING TO A SUBSTRATE.

**FOOTPRINT**



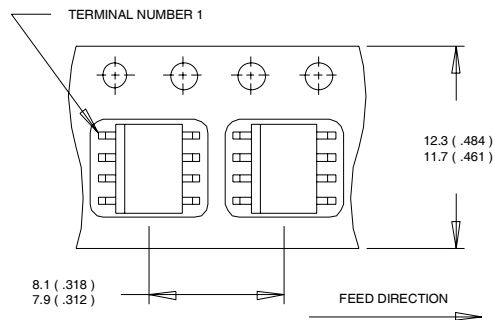
## SO-8 (Fetky) Part Marking Information

EXAMPLE: THIS IS AN IRF7807D1 (FETKY)

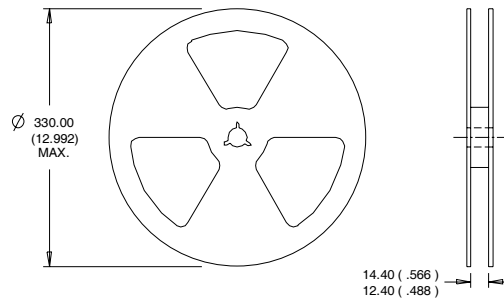


## SO-8 Tape and Reel

Dimensions are shown in millimeters (inches)



- NOTES:
1. CONTROLLING DIMENSION : MILLIMETER.
  2. ALL DIMENSIONS ARE SHOWN IN MILLIMETERS(INCHES).
  3. OUTLINE CONFORMS TO EIA-481 & EIA-541.



- NOTES:
1. CONTROLLING DIMENSION : MILLIMETER.
  2. OUTLINE CONFORMS TO EIA-481 & EIA-541.

Data and specifications subject to change without notice.  
 This product has been designed and qualified for the Consumer market.  
 Qualification Standards can be found on IR's Web site.

# Mouser Electronics

Authorized Distributor

Click to View Pricing, Inventory, Delivery & Lifecycle Information:

[Infineon:](#)

[IRF7342D2PBF](#) [IRF7342D2TRPBF](#)