

### FEATURES

- ◆ Wide operating voltage range of 10 to 45 Vdc
- ◆ PWM control for coil currents of 40 to 300 mA
- ◆ Coil current for energise and hold modes set by an external resistor
- ◆ Coil current monitored during energise mode, detection of load breakage and voltage errors
- ◆ Automatic current reduction after 100 ms to reduce the power consumption in hold mode
- ◆ The internal free-wheeling alteration function supports PWM operation and quick demagnetising during shutdown
- ◆ Status signalled at the current-limited LED output
- ◆ Shutdown with excessive temperature and low voltage
- ◆ Integrated oscillator needs no external components
- ◆ PWM frequency is beyond audible range
- ◆ Protective circuitry against damage by ESD
- ◆ Minimum space requirements, few external components

### APPLICATIONS

- ◆ PWM drive for inductive loads (e.g. relays, electrovalves)
- ◆ Relay low-/high-side switch

### PACKAGES

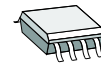

SO8

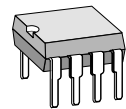

PDIP8

### BLOCK DIAGRAM

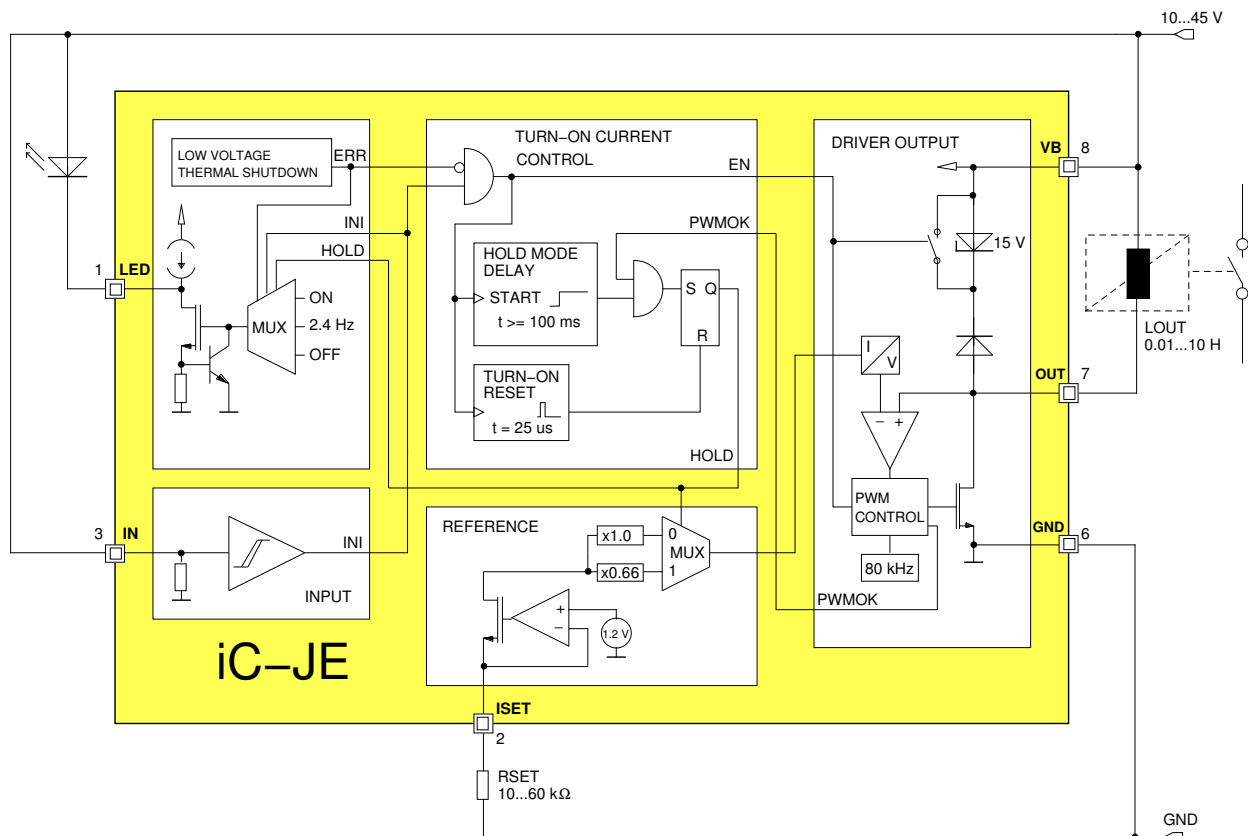

**DESCRIPTION**

iC-JE is a PWM driver for inductive loads, such as relay coils, solenoid valves and small DC motors.

The setpoint for the coil current is preset with the help of the RSET external resistor. 60 to 300 mA can be set for energise mode which then automatically drop to 2/3 of this value (40 to 200 mA) during hold mode. The device is switched to hold mode after 100 ms provided that the set coil current is obtained during energising (PWMOK = 1).

The changeover between energise and hold modes is suitable for typical relay drives which require a powerful initial energising current which can then be reduced after closing the air gap in a magnetic circuit. The quadratic dependence on the current intensity means that the power dissipation of the system is more than halved through this reduction.

The output current is measured with zero loss at the power transistor's ON resistance and compared to the setpoint. In order to maintain this setpoint, the

switch-on time of the coil driver is modulated by the pulse width. The internal flyback diode maintains the current during the switching pauses. The switching frequency of ca. 80 kHz is provided by the internal oscillator.

The device is shutdown by a Low signal at input IN or the removal of the power supply; the current reduction in the coil is supported by the changeover of the free-wheeling circuit. The Zener diode now active permits higher free-wheeling voltages and thus a quicker demagnetising of the coil.

The status indicator LED is constantly ON when hold mode is functioning correctly and flashes with low voltage, excessive temperature or when the coil current in energise mode has not reached the setpoint. The driver output is shutdown with low voltage or excessive temperature.

The device is protected against destruction by ESD.

**PACKAGES SO8, PDIP8 to JEDEC**

**PIN CONFIGURATION SO8 (top view)**

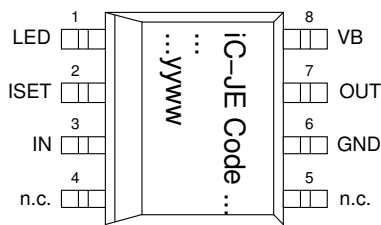

**PIN FUNCTIONS**

**No. Name Function**

1	LED	State monitor
2	ISET	PWM Reference Current (setpoint adjustment)
3	IN	Input
4	n.c.	
5	n.c.	
6	GND	Ground
7	OUT	PWM Output
8	VB	+10 to 45 V Supply Voltage

**PIN CONFIGURATION PDIP8 (top view)**

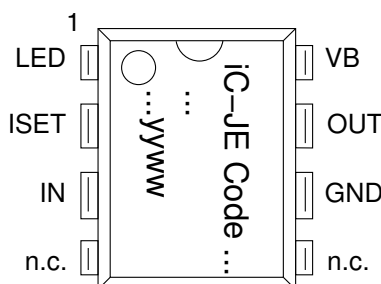

### ABSOLUTE MAXIMUM RATINGS

Beyond these values damage may occur; device operation is not guaranteed.

Item No.	Symbol	Parameter	Conditions	Fig.			Unit
					Min.	Max.	
G001	V(VB)	Voltage at VB			-0.3	48	V
G002	I(VB)	Current in VB			-350	6	mA
G003	V(OUT)	Voltage at OUT			-0.3	60	V
G004	I(OUT)	Output Current in OUT			-6	350	mA
G005	V(LED)	Voltage at LED			-0.3	VB	V
G006	I(LED)	Current in LED			-6	8	mA
G007	V(ISET)	Voltage at ISET			-0.3	48	V
G008	I(ISET)	Current in ISET			-6	6	mA
G009	V(IN)	Voltage at IN			-0.3	48	V
G010	I(IN)	Current in IN			-6	6	mA
G011	T <sub>J</sub>	Junction Temperature			-40	150	°C
G012	T <sub>s</sub>	Storage Temperature			-40	150	°C

### THERMAL DATA

Operating Conditions: VB = 10...45 V, LOUT = 0.01...10 H, RSET = 10...60 kΩ

Item No.	Symbol	Parameter	Conditions	Fig.				Unit
					Min.	Typ.	Max.	
T01	T <sub>a</sub>	Operating Ambient Temperature Range			-25		80	°C
T02	R <sub>thja</sub>	Thermal Resistance Chip/Ambient	PDIP8 package				110	K/W
T03	R <sub>thja</sub>	Thermal Resistance Chip/Ambient	SO8 package				140	K/W

All voltages are referenced to ground unless otherwise stated.

All currents into the device pins are positive; all currents out of the device pins are negative.

### ELECTRICAL CHARACTERISTICS

Operating Conditions:  $V_B = 10...45\text{ V}$ ,  $L_{OUT} = 0.01...10\text{ H}$ ,  $R_{SET} = 10...60\text{ k}\Omega$ ,  $T_j = -25...125\text{ }^\circ\text{C}$ , unless otherwise noted.  
LED connected or pin LED linked to GND (via ca.  $500\ \Omega$  resistor or capacitor).

Item No.	Symbol	Parameter	Conditions	Tj °C	Fig.				Unit
						Min.	Typ.	Max.	
<b>Total Device</b>									
001	$V_B$	Permissible Supply Voltage Range				10		45	V
002	$I(V_B)$	Supply Current in $V_B$	Outputs OUT, LED disabled			0.5		2	mA
003	$I(V_B)$	Supply Current in $V_B$	Output OUT enabled			0.5		3	mA
004	$V_c(\text{lo})$	Clamp Voltage lo at all Pins	$I() = -4\text{ mA}$ , other Pins open			-1.4		-0.3	V
005	$V_c(\text{hi})$	Clamp Voltage hi at $V_B$ , IN, ISET	$I() = 4\text{ mA}$ , other Pins open			48	57		V
006	$V_c(\text{hi})$	Clamp Voltage hi at OUT	$I(\text{OUT}) = 4\text{ mA}$ , other Pins open			60	71		V
007	$V_c(\text{hi})$	Clamp Voltage hi at LED vs. $V_B$	$V_c(\text{hi}) = V(\text{LED}) - V(V_B)$ ; $I(\text{LED}) = 4\text{ mA}$ , other Pins open			0.3		1.4	V
<b>Driver Output OUT</b>									
101	$V_s(\text{lo})$	Saturation Voltage lo	$I(\text{OUT}) = 200\text{ mA}$		1		360	600	mV
102	$V_s(\text{lo})$	Saturation Voltage lo	$I(\text{OUT}) = 300\text{ mA}$		1		550	850	mV
103	PWMthi	Permissible Energising Current	Increased Energising Current by RC-circuit at ISET, Hold Current 200 mA max.		1, 5, 6			300 350	mA mA
104	PWMthi	Permissible Hold Current			1	40			mA
105	$I_{sc}()$	Short-circuit Current	$V(\text{OUT}) = V_B$			0.6	1	1.7	A
106	$V_c(\text{hi})$	Clamp Voltage hi at PWM-Free-Wheeling	$V_c(\text{hi}) = V(\text{OUT}) - V_B$ ; IN = hi, $I(\text{OUT}) = 200\text{ mA}$		1		1	1.5	V
107	$V_c(\text{hi})$	Clamp Voltage hi at PWM-Free-Wheeling	$V_c(\text{hi}) = V(\text{OUT}) - V_B$ ; IN = hi, $I(\text{OUT}) = 300\text{ mA}$		1		1.4	2	V
108	$V_c(\text{off})$	Clamp Voltage hi at Turn-off	$V_c(\text{hi}) = V(\text{OUT}) - V_B$ ; IN: hi $\rightarrow$ lo, $I(\text{OUT}) = 200\text{ mA}$		1	12	15	17	V
109	$I_{IK}()$	Leakage Current	IN = lo, $V(\text{OUT}) = 0...V_B$				1	10	$\mu\text{A}$
110	$t_{\text{won}}(\text{min})$	Minimum PWM Turn-on Duration	IN = hi, ISET open		1	250		1000	ns
111	$C()$	Permissible Load Capacitance						1	nF
<b>Input IN</b>									
201	$V_t(\text{on})$	Threshold Voltage hi				2.6	2.85	3.2	V
202	$V_t(\text{off})$	Threshold Voltage lo				1.7	2.0	2.3	V
203	$V_t(\text{hys})$	Hysteresis	$V_t(\text{hys}) = V_t(\text{on}) - V_t(\text{off})$			0.7	0.85	1.1	V
204	$I_{pd}()$	Pull-down Current	$V(\text{IN}) = 4...45\text{ V}$			50	100	200	$\mu\text{A}$
205	$R_{pd}()$	Pull-down Resistor	$V(\text{IN}) = 0...4\text{ V}$			20	50	80	$\text{k}\Omega$
206	$t_p(\text{IN-OUT})$	Turn-on Delay	IN: lo $\rightarrow$ hi					20	$\mu\text{s}$
207	$t_p(\text{IN-OUT})$	Turn-off Delay	IN: hi $\rightarrow$ lo					10	$\mu\text{s}$
208	$t_p(\text{VB-OUT})$	Turn-on Delay when $V_B$ is powered up	IN = $V_B$ , $V_B = V_{\text{Boff}} \rightarrow V_{\text{Bon}}$					40	$\mu\text{s}$
209	$t_p(\text{IN-LED})$	Delay Time from IN to LED (with light permanently on)	PWMOK = 1 before $t_p\text{PMWlo}$			65	100	135	ms
210	$t_p(\text{IN-LED})$	Delay Time from IN to LED (with light flashing)	PWMOK = 0			130	200	270	ms
<b>Status Monitor LED</b>									
301	$I_{pd}()$	Pull-down Current	$V(\text{LED}) = 5\text{ V}...V_B$			3	5	8	mA
302	$V_s(\text{lo})$	Saturation Voltage lo	$I(\text{LED}) = 200\ \mu\text{A}$					0.4	V
303	$I_{pu}()$	Pull-up Current	$V(\text{LED}) = 0\text{ V}...(V_B - 1\text{ V})$			-20	-100	-300	$\mu\text{A}$
304	$V_{Blo}$	Permissible Supply Voltage for Monitoring Function				6		45	V
305	$V_{Bon}$	Turn-on Threshold at $V_B$				7.6	8	8.4	V
306	$V_{Boff}$	Undervoltage Threshold at $V_B$	Decreasing voltage $V_B$			7.1	7.5	7.9	V
307	$V_{Bhys}$	Hysteresis	$V_{Bhys} = V_{Bon} - V_{Boff}$			200	500	800	mV
308	$T_{off}$	Thermal Shutdown Temperature				130	140	150	$^\circ\text{C}$

### ELECTRICAL CHARACTERISTICS

Operating Conditions:  $V_B = 10...45\text{ V}$ ,  $L_{OUT} = 0.01...10\text{ H}$ ,  $R_{SET} = 10...60\text{ k}\Omega$ ,  $T_j = -25...125\text{ }^\circ\text{C}$ , unless otherwise noted.  
 LED connected or pin LED linked to GND (via ca.  $500\text{ }\Omega$  resistor or capacitor).

Item No.	Symbol	Parameter	Conditions	Tj °C	Fig.	Min.	Typ.	Max.	Unit
309	Ton	Thermal Lock-on Threshold	Decreasing temperature			110	120	130	°C
310	Thys	Thermal Shutdown Hysteresis	$T_{hs} = T_{off} - T_{on}$			10	20	30	°C
311	f()	Flash Frequency on Error	ERR = hi or PWMOK = 0, $V_B = 6...45\text{ V}$			1.8	2.4	3.6	Hz
<b>Reference ISET</b>									
401	V()	Reference Voltage				1.14	1.20	1.26	V
402	Isc()	Short-Circuit Current	$V(ISET) = 0\text{ V}$			-2.5	-1.8	-0.3	mA
403	K1	Transfer Value for Energising Current $R_{SET} = K1 / I(OUT)_{start}$	$I(OUT)_{start} = 60...300\text{ mA}$		1	2900	3400	3900	A $\Omega$
404	CRrel	Relative Current Ratio $I_t(OUT)_{hold} / I_t(OUT)_{start}$ (Trigger Thresholds Ratio: Hold vs. Energise Mode)	$I(OUT)_{start} = 60...300\text{ mA}$		1	63	66	71	%
405	K2	Transfer Value for Hold Current $R_{SET} = K2 / I(OUT)_{hold}$	$I(OUT)_{hold} = 40...200\text{ mA}$			1930	2315	2700	A $\Omega$
<b>Oscillator</b>									
501	fosc	Oscillator Frequency			1	60	80	120	kHz
<b>Turn-on Current Control</b>									
601	tpPWMlo	Hold Mode Propagation Delay	PWMOK = 1 before tpPWMlo			65	100	135	ms

### ELECTRICAL CHARACTERISTICS: Diagrams

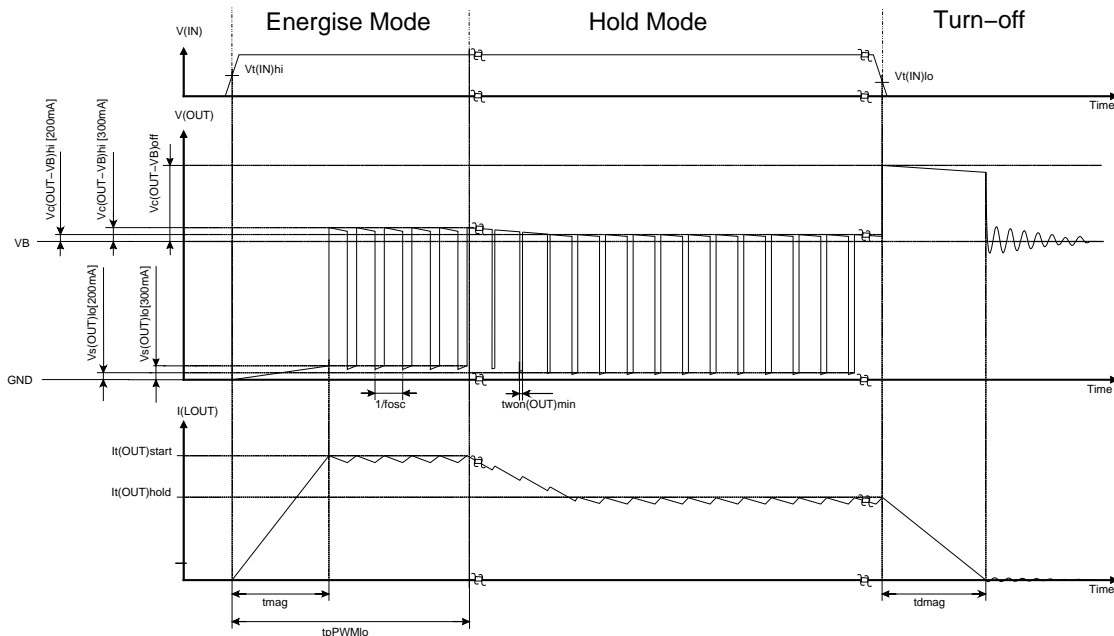

Figure 1: Operation modes: energise mode, hold mode and turn-off

$$t_{mag} \approx \frac{I_t(OUT)_{start} \times L_{OUT}}{V_B} \quad (1)$$

$$t_{dmag} \approx \frac{I_t(OUT)_{hold} \times L_{OUT}}{V_c(OUT - V_B)_{hi}} \quad (2)$$

### APPLICATIONS INFORMATION

#### Setting the coil current

The following equations can be given for the energise and hold modes of the PWM control using Electrical Characteristics Nos. 403 to 408:

$$RSET = \frac{K1}{I(OUT)_{start}} \quad (3)$$

$$RSET = \frac{K2}{I(OUT)_{hold}} \quad (4)$$

#### Example

For a relay with a starting current of 100 mA (66 mA hold current) RSET is calculated as:

$$RSET = \frac{3250 \Omega A}{0.1 A} = 32.5 k\Omega \quad (5)$$

#### Application circuits

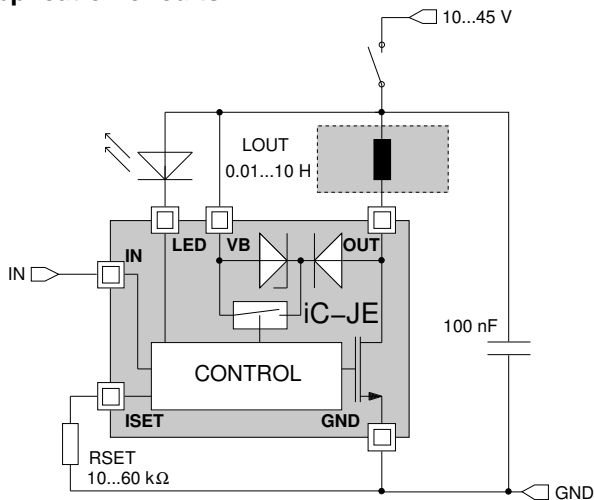

Figure 2: Driver/relay combination activated via the external control input IN

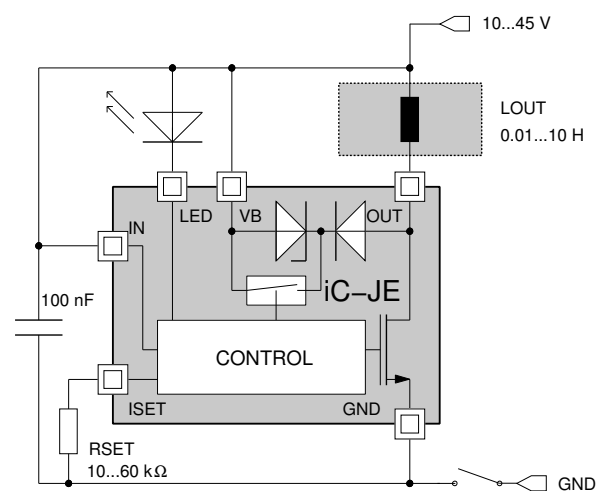

Figure 3: Driver/relay combination activated via the supply pin GND

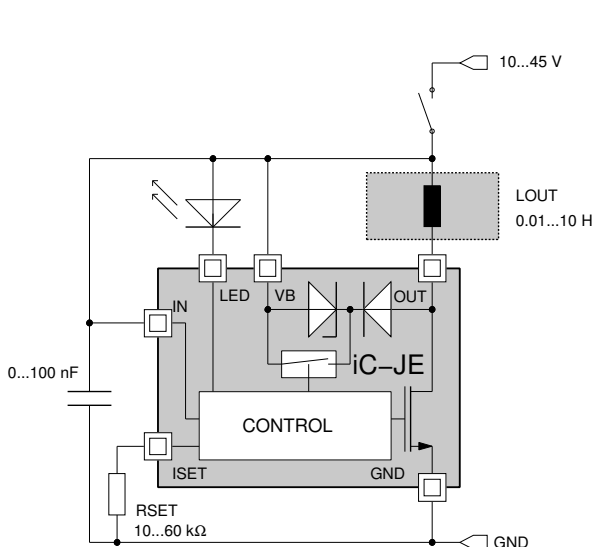

Figure 4: Driver/relay combination activated via the supply pin VB

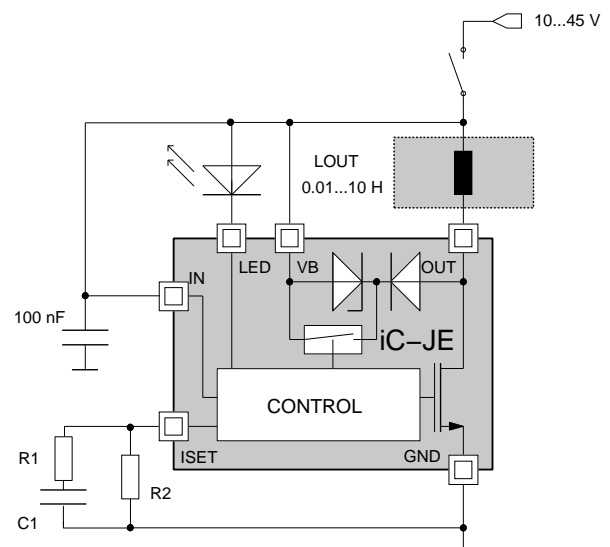

Figure 5: Increased energizing current due to the parallel RC-circuit

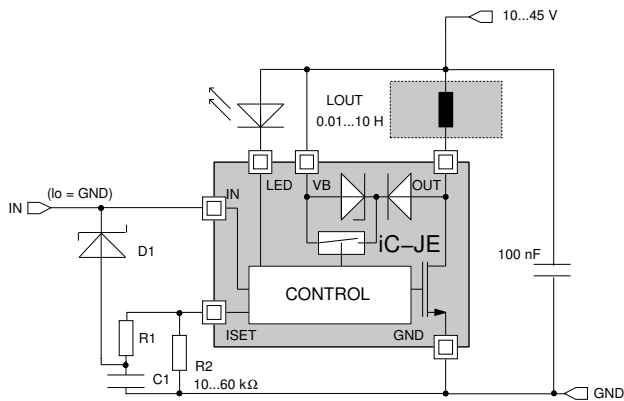

Figure 6: Activation via pin IN with an increased energizing current. An additional Schottky diode discharges C1 if IN is switched to low (GND)

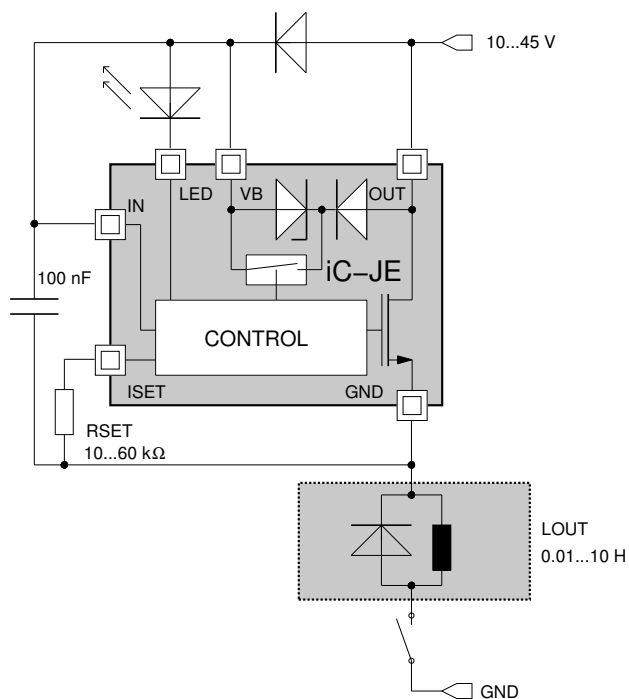

Figure 7: High-side driver for an external relay with a flyback diode

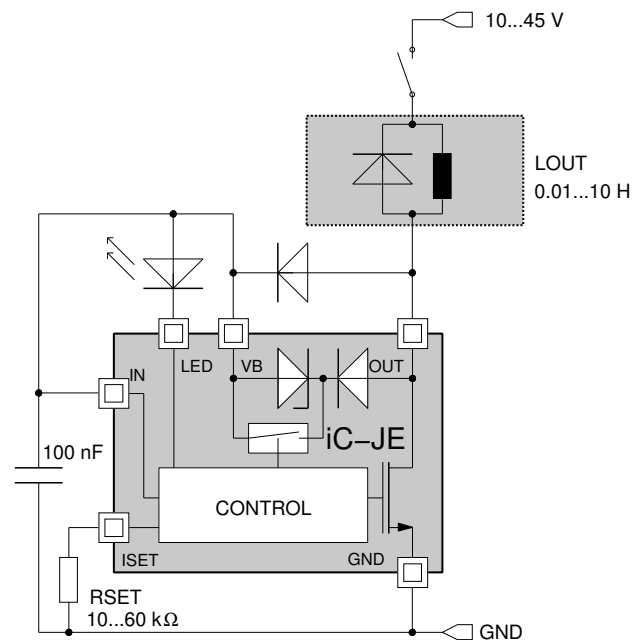

Figure 8: Low-side driver for an external relay with a flyback diode

### EVALUATION BOARD

The iC-JE is equipped with an Evaluation Board for test purposes. The following figures show the circuit diagram as well as the top and bottom layout of the test PCB.

The board comes with a strap between IN and SENSE1 (application equal to Fig. 4). The actual coil current can be measured by the voltage drop between SENSE1 and SENSE2 (1 mV/mA).

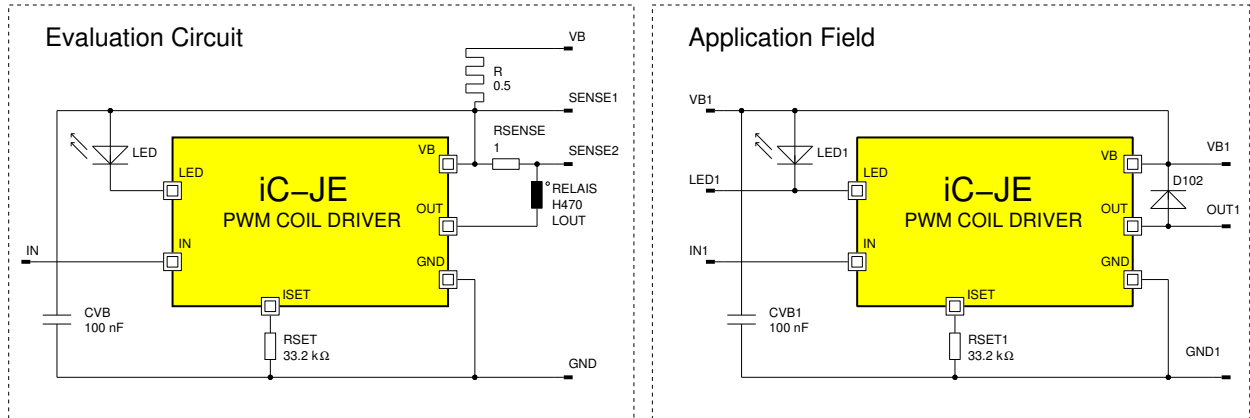

Figure 9: Schematic diagram of the Evaluation Board

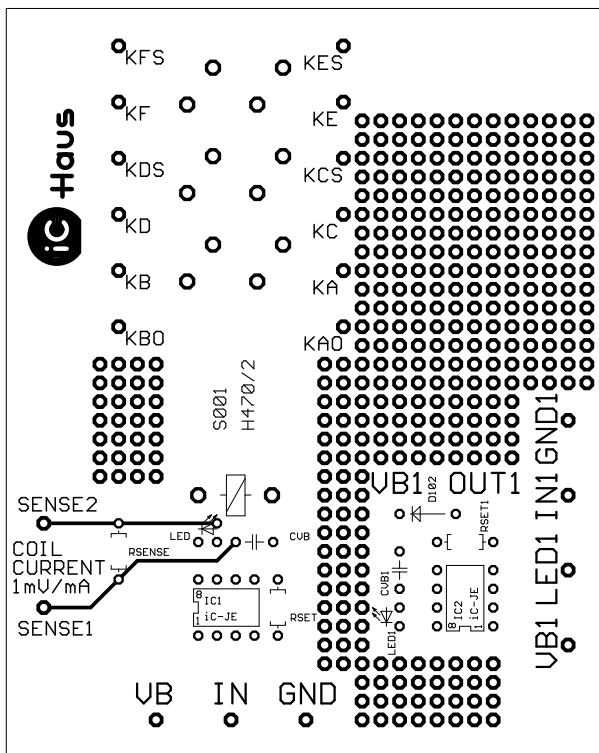

Figure 10: Evaluation Board (components side)

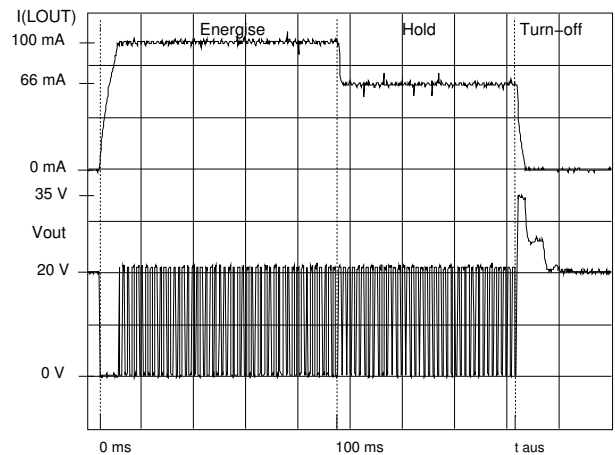

Figure 11: Oscilloscope graph of the evaluation circuit (sampled)

This specification is for a newly developed product. iC-Haus therefore reserves the right to change or update, without notice, any information contained herein, design and specification; and to discontinue or limit production or distribution of any product versions. Please contact iC-Haus to ascertain the current data. Copying – even as an excerpt – is only permitted with iC-Haus approval in writing and precise reference to source. iC-Haus does not warrant the accuracy, completeness or timeliness of the specification on this site and does not assume liability for any errors or omissions in the materials. The data specified is intended solely for the purpose of product description. No representations or warranties, either express or implied, of merchantability, fitness for a particular purpose or of any other nature are made hereunder with respect to information/specification or the products to which information refers and no guarantee with respect to compliance to the intended use is given. In particular, this also applies to the stated possible applications or areas of applications of the product. iC-Haus conveys no patent, copyright, mask work right or other trade mark right to this product. iC-Haus assumes no liability for any patent and/or other trade mark rights of a third party resulting from processing or handling of the product and/or any other use of the product.

**ORDERING INFORMATION**

Type	Package	Order Designation
iC-JE	PDIP8 SO8	iC-JE PDIP8 iC-JE SO8
Evaluation Board		iC-JE EVAL JE1D

For information about prices, terms of delivery, other packaging options etc. please contact:

**iC-Haus GmbH**  
Am Kuemmerling 18  
D-55294 Bodenheim  
GERMANY

**Tel.: +49 (61 35) 92 92-0**  
**Fax: +49 (61 35) 92 92-192**  
**Web: <http://www.ichaus.com>**  
**E-Mail: [sales@ichaus.com](mailto:sales@ichaus.com)**