

KEMET Part Number: HHBC24N-2R0A0219V
(UALC4N2R0A0219)

KEMET, HHBC, AC Line Filters, Normal Mode, 219 uH, 20%

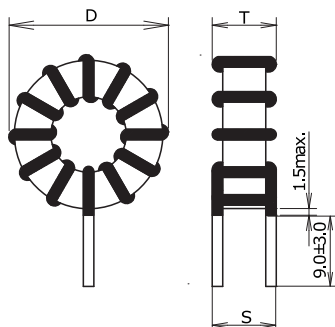

Dimensions	
D	50.5mm MAX
T	26.5mm MAX
LL	9mm +/-3mm
S	19mm NOM

Packaging Specifications	
Packaging:	Tray
Packaging Quantity:	60
Weight:	149 g

General Information	
Series:	HHBC
Style:	Through-Hole
Features:	Noise Solution, Switching Power Supply Outlets, DC-DC Converter
RoHS:	Yes
Miscellaneous:	65 (K) Temperature Rise Max.

Specifications	
Inductance:	219 uH
Inductance Tolerance:	20%
Current:	15 A
Temperature Range:	-40/+125°C
DC Resistance:	19.5 mOhms