

Plastic Fiber Optic Cable

Simplex Fiber Optic Cable is constructed of a single step index plastic fiber sheathed in a plastic jacket. Duplex Fiber Optic Cable has two plastic fibers, each in a cable of construction similar to the Simplex Cable, joined with a web. The individual channels are identified by a marking on one channel of the cable. The Improved Fiber Optic Cable is identical to the Standard Cable except that the attenuation is lower.

These cables are UL recognized components and pass UL VW-1 flame retardancy specification. Safe cable properties in flammable environments, along with non-conductive electrical characteristics of the cable may make the use of conduit unnecessary. Plastic cable is available unconnected or connected. Refer to page 5-34 for part numbers.

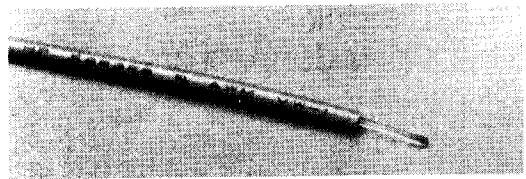

SIMPLEX CABLE

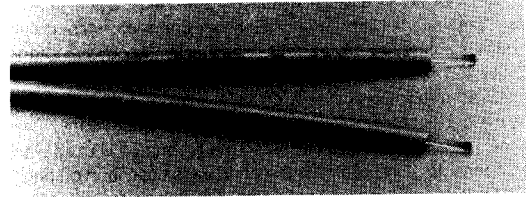

DUPLEX CABLE

Absolute Maximum Ratings

Parameter	Symbol	Min.	Max.	Units	Ref.
Storage Temperature	T_S	-40	+75	°C	
Installation Temperature	T_I	-20	+70	°C	
Short Term Tensile Force	Single Channel		50	N	Note 1
	Dual Channel		100	N	
Short Term Bend Radius	r	10		mm	Note 2
Long Term Bend Radius	r	35		mm	
Long Term Tensile Load	F_T		1	N	
Flexing			1000	Cycles	Note 3
Impact	m		0.5	kg	Note 4
	h		150	mm	

Electrical/Optical Characteristics 0°C to +70°C Unless Otherwise Specified

Parameter	Symbol	Min.	Typ. ^[5]	Max.	Units	Conditions	Ref.
Cable Attenuation	Standard Cable	0.19	0.31	0.43	dB/m	Source is HFBR-152X/153X (660 nm), $\ell = 20$ m	Note 7
	Improved Cable	0.19	0.25	0.31			
Numerical Aperture	N.A.		0.5			$\ell > 2$ m	
Diameter, Core	D_C		1.0		mm		
Diameter, Jacket	D_J		2.2		mm	Simplex Cable	
Travel Time Constant	ℓ/v		5.0		nsec/m		Note 6
Mass per Unit Length/Channel	m/ℓ		4.6		g/m	Without Connectors	
Cable Leakage Current	I_L		12		nA	50 kV, $\ell = 0.3$ m	

- Notes:**
- Less than 30 minutes.
 - Less than 1 hour, non-operating.
 - 90° bend on 10 mm radius mandrel. Bend radius is the radius of the mandrel around which the cable is bent.
 - Tested at 1 impact according to MIL-STD-1678, Method 2030, Procedure 1.
 - Typical data is at 25°C.
 - Travel time constant is the reciprocal of the group velocity for propagation of optical power. Group velocity is $v = c/n$, where c is the velocity of light in space (3×10^8 m/s) and n equals effective core index of refraction. Unit length of cable is ℓ .
 - In addition to standard Hewlett-Packard 100% product testing, HP provides additional margin to ensure link performance. Under certain conditions, cable installation and improper connecting may reduce performance. Contact Hewlett-Packard for recommendations.
 - Improved cable is available in 500 metre spools and in factory-connected lengths less than 100 metres.

Versatile Link Fiber Optic Connectors

CONNECTORS FEEDTHROUGH/SPLICE POLISHING TOOLS

Versatile Link transmitters and receivers are compatible with three connector styles; simplex, simplex latching, and duplex. All connectors provide a snap-action when mated to Versatile Link components. Simplex connectors are color coded to match with transmitter and receiver color coding. Duplex connectors are keyed so that proper orientation is ensured. When removing a connector from a module, pull at the connector body. Do not pull on the cable alone. The same, quick and simple connectoring technique is used with all connectors and cable. This technique is described on page 18. Note that simplex and duplex crimp rings are different.

Simplex Connector Styles

HFBR-4501/4511 — Simplex

The simplex connector provides a quick and stable connection for applications that require a component to provide retention force of 8 newtons (1.8 lb). These connectors are available in colors of gray (HFBR-4501) or blue (HFBR-4511).

HFBR-4503/4513 — Simplex Latching

The simplex latching connector is designed for rugged applications requiring greater retention force, 80 N (18 lbs), than that provided by a simplex connector. When inserting the simplex latching connector into a module, the connector latch mechanism should be aligned with the top surface of the horizontal module, or with the tall vertical side of the vertical module. Misorientation of an inserted latching connector into either module housing will not result in a positive latch. The connector is released by depressing the rear section of the connector lever, and then pulling the connector assembly away from the module housing.

If the cable/connector will be used at elevated operating temperatures or experience frequent and wide temperature cycling effects, the cable/connector attachment can be strengthened by applying a RTV adhesive within the connector. A recommended adhesive is GE Company RTV-128. In most applications, use of RTV is unnecessary. The simplex latching connector is available in gray (HFBR-4503) or blue (HFBR-4513).

Duplex Connector HFBR-4506 — Duplex

Duplex connectors provide convenient duplex cable termination and are keyed to prevent incorrect connection. The duplex connector is compatible with dual combinations of identical Versatile Link components (e.g., two horizontal transmitters, two vertical receivers, a horizontal transmitter and a horizontal receiver, etc.). A duplex connector cannot connect to two different packages simultaneously. The duplex connector is an off-white color.

Feedthrough/Splice HFBR-4505/4515 — Adapter

The HFBR-4505/4515 adapter mates two simplex connectors for panel/bulkhead feedthrough of plastic fiber cable. Maximum panel thickness is 4.1 mm (0.16 inch). This adapter can serve as a cable in-line splice using two simplex connectors. The colors of the adapters are gray (HFBR-4505) and blue (HFBR-4515). The adapter is not compatible with the duplex or simplex latching connectors.

Absolute Maximum Ratings

Parameter	Symbol	Min.	Max.	Units	Notes
Storage Temperature	T _S	-40	+75	°C	
Operating Temperature	T _A	0	+70	°C	
Nut Torque HFBR-4505/4515	T _N		0.7	N-m	1
			100	OzF-in	

Notes:

1. Recommended nut torque is 0.57 N-m (80 OzF-in).

HFBR-4501 (GRAY)/4511 (BLUE) SIMPLEX CONNECTOR



HFBR-4503 (GRAY)/4513 (BLUE) SIMPLEX LATCHING CONNECTOR

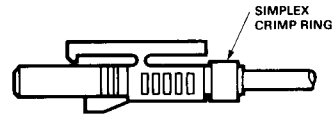

HFBR-4506 (PARCHMENT) DUPLEX CONNECTOR

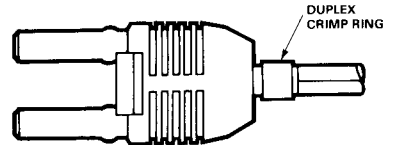

HFBR-4516 (PARCHMENT) DUPLEX LATCHING CONNECTOR

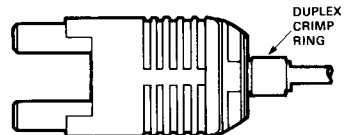

HFBR-4505 (GRAY)/4515 (BLUE) ADAPTER

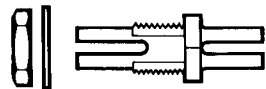

(USE WITH SIMPLEX CONNECTORS ONLY)

Connector Applications

ATTACHMENT TO HEWLETT-PACKARD HFBR-152X/153X/252X/253X VERSATILE LINK FIBER OPTIC COMPONENTS

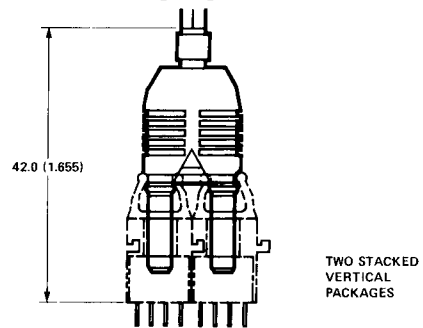
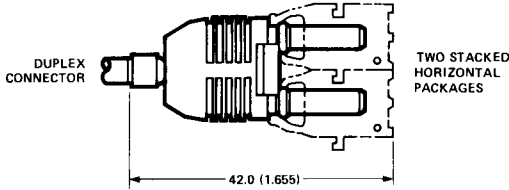
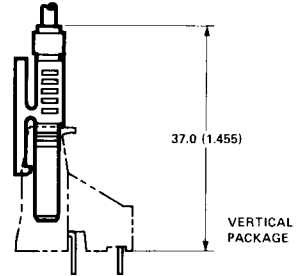
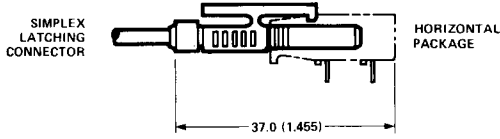
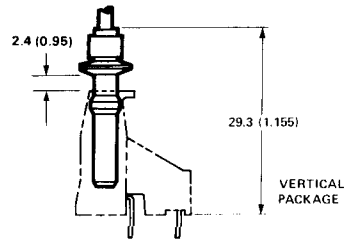
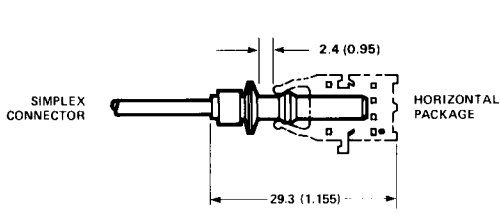

DIMENSIONS IN MILLIMETRES (INCHES)

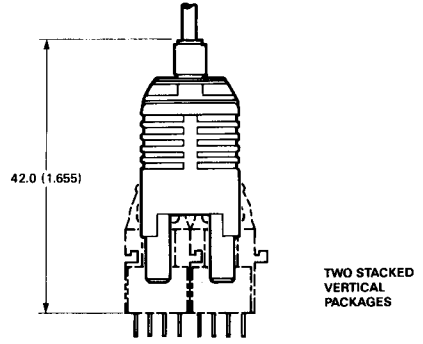
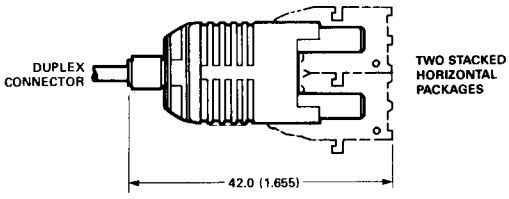

DIMENSIONS IN MILLIMETRES (INCHES)

BULKHEAD FEEDTHROUGH OR PANEL MOUNTING FOR HFBR-4501/4511 SIMPLEX CONNECTORS

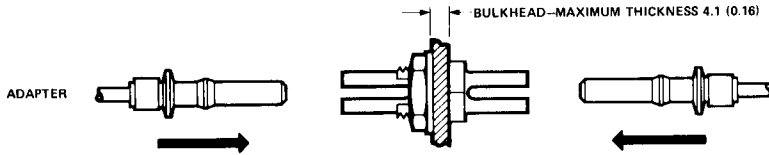

FIBER OPTICS

IN-LINE SPLICE FOR HFBR-35XX/36XX FIBER OPTIC CABLE WITH HFBR-4501/4511 SIMPLEX CONNECTORS

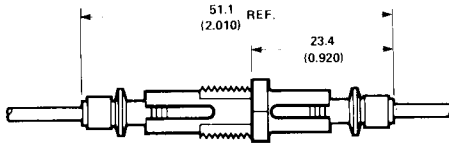

DIMENSIONS IN MILLIMETRES (INCHES)

Connector Mechanical/Optical Characteristics 25°C Unless Otherwise Specified.

Parameter	Part Number		Sym.	Min.	Typ.	Max.	Units	Ref.
Retention Force Connector to HFBR-152X 153X/252X/253X Modules	Simplex	HFBR-4501/4511	F _{R-C}	7	8		N	Note 4
	Simplex Latching	HFBR-4503/4513		47	80			
	Duplex	HFBR-4506		7	12			
	Duplex Latching	HFBR-4516		50	80			
Tensile Force Connector to Cable	Simplex	HFBR-4501/4511	F _T	8.5	22		N	Notes 3, 4
	Simplex Latching	HFBR-4503/4513		8.5	22			
	Duplex	HFBR-4506		14	35			
	Duplex Latching	HFBR-4516		14	35			
Adapter Connector to Connector Loss	HFBR-4505/4515 with HFBR-4501/4511		α _{CC}	0.7	1.5	2.8	dB	Notes 1, 5
Retention Force Connector to Adapter	HFBR-4505/4515 with HFBR-4501/4511		F _{R-B}	7	8		N	Note 4
Insertion Force Connector to HFBR-152X/153X/252X/253X Modules	Simplex	HFBR-4501/4511	F _I		8	12	N	Notes 2, 4
	Simplex Latching	HFBR-4503/4513			16	35		
	Duplex	HFBR-4506			13	46		
	Duplex Latching	HFBR-4516			22	51		

Notes:

1. Factory polish or field polish per recommended procedure.
2. No perceivable reduction in insertion force was observed after 2000 insertions. Destructive insertion force was typically at 178 N (40 lbs).
3. For applications where frequent temperature cycling over temperature extremes is expected please contact Hewlett-Packard for alternate connecting techniques.
4. All mechanical forces were measured after units were stored at 70°C for 168 hours and returned to 25°C for one hour.
5. Minimum and maximum limits of α_{CC} are for 0°C to 70°C temperature range. Typical value of α_{CC} is at 25°C.

Connecting

The following easy procedure describes how to make cable terminations. It is ideal for both field and factory installation. If a high volume connecting technique is required please contact your Hewlett-Packard sales engineer for the recommended procedure and equipment.

Connecting the cable is accomplished with the Hewlett-Packard HFBR-4593 Polishing Kit consisting of a Polishing Fixture, 600 grit abrasive paper and 3-μm pink lapping film (3M Company, OC3-14). No adhesive material is needed to secure the cable in the connector, and the connector can be used immediately after polishing. Improved connector to cable attachment can be achieved with the use of a RTV (GE Company, RTV-128) adhesive for frequent, extreme temperature cycling environments or for elevated temperature operation.

Connectors may be easily installed on the cable ends with readily available tools. Materials needed for the terminating procedure are:

- 1) Hewlett-Packard Plastic Fiber Optic Cable
- 2) HFBR-4593 Polishing Kit
- 3) HFBR-4501/4503 Gray Simplex/Simplex Latching Connector and Silver Color Crimp Ring
- 4) HFBR-4511/4513 Blue Simplex/Simplex Latching Connector and Silver Color Crimp Ring
- 5) HFBR-4506 Parchment Duplex Connector and Duplex Crimp Ring
- 6) Industrial Razor Blade or Wire Cutters
- 7) 16 Gauge Latching Wire Strippers
- 8) Crimp Tool, HFBR-4597

Step 1

The zip cord structure of the duplex cable permits easy separation of the channels. The channels should be separated approximately 50 mm (2.0 in.) back from the ends to permit connecting and polishing.

After cutting the cable to the desired length, strip off approximately 7 mm (0.3 in.) of the outer jacket with the 16 gauge wire strippers. Excess webbing on duplex cable may have to be trimmed to allow the simplex or simplex latching connector to slide over the cable.

When using the duplex connector and duplex cable, the separated duplex cable must be stripped to equal lengths on each cable. This allows easy and proper seating of the cable into the duplex connector.

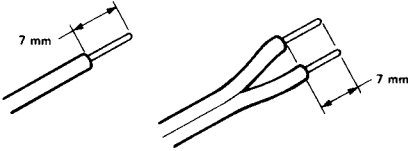

Step 2

Place the crimp ring and connector over the end of the cable; the fiber should protrude about 3 mm (0.12 in.) through the end of the connector. Carefully position the ring so that it is entirely on the connector with the rim of the crimp ring flush with the connector, leaving a small space between the crimp ring and the flange. Then crimp the ring in place with the crimping tool. One crimp tool is used for all connector crimping requirements.

Note: Place the gray connector on the cable end to be connected to the transmitter and the blue connector on the cable end to be connected to the receiver to maintain the color coding (both connectors are the same mechanically). For duplex connector and duplex cable application, align the color coded side of the cable with the appropriate ferrule of the duplex connector in order to match connections to the respective optical ports. The simplex connector crimp ring cannot be used with the duplex connector. The duplex connector crimp ring cannot be used with the simplex or simplex latching connectors. The simplex crimp has a dull lustre; the duplex ring is shiny and has a thinner wall.

SIMPLEX

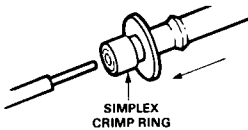

SIMPLEX LATCHING

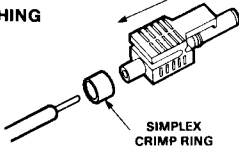

DUPLEX/DUPLEX LATCHING

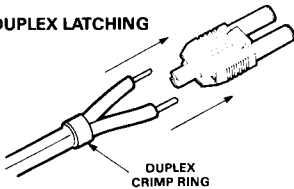

Step 3

Any excess fiber protruding from the connector end may be cut off; however, the trimmed fiber should extend at least 1.5 mm (0.06 in.) from the connector end.

Insert the connector fully into the polishing fixture with the trimmed fiber protruding from the bottom of the fixture. This plastic polishing fixture can be used to polish two simplex connectors or two simplex latching connectors simultaneously, or one duplex connector.

Note: The four dots on the bottom of the polishing fixture are wear indicators. Replace the polishing fixture when any dot is no longer visible.

Place the 600 grit abrasive paper on a flat smooth surface. Pressing down on the connector, polish the fiber and the connector using a figure eight pattern of strokes until the connector is flush with the bottom of the polishing fixture. Wipe the connector and fixture with a clean cloth or tissue.

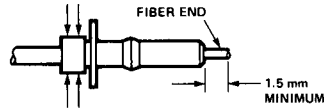

Step 4

Place the flush connector and polishing fixture on the dull side of the 3 micron pink lapping film and continue to polish the fiber and connector for approximately 25 strokes. The fiber end should be flat, smooth and clean.

The cable is now ready for use.

Note: Use of the pink lapping film fine polishing step results in approximately 2 dB improvement in coupling performance of either a transmitter-receiver link or a bulk-head/splice over 600 grit polish alone. This fine polish is comparable to Hewlett-Packard factory polish. The fine polishing step may be omitted where an extra 2 dB of optical power is not essential, as with short link lengths. Proper polishing of the tip of the fiber/connector face results in a tip diameter between 2.8 mm (0.110 in.) minimum and 3.2 mm (0.125 in.) maximum.

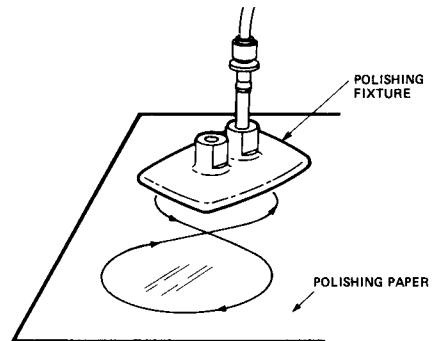

For simultaneous multiple connector polishing techniques please contact Hewlett-Packard.

HFBR-4593 POLISHING KIT

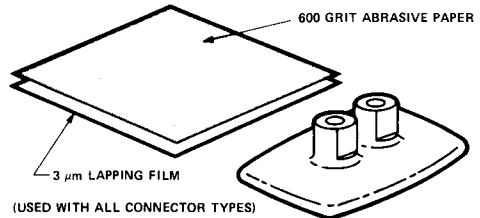

Ordering Guide

TRANSMITTERS (T_x)/RECEIVERS (R_x) Pages 5-24/5-27

Versatile Link	Unit	Horizontal Modules	Vertical Modules
5 MBd High Performance	T _x	HFBR-2521	HFBR-2531
1 MBd High Performance	T _x	HFBR-2522	HFBR-2532
40 kBd Low Current/ Extended Distance	T _x	HFBR-2523	HFBR-2533
1 MBd Standard	T _x	HFBR-2524	HFBR-2534
5 MBd High Performance	R _x	HFBR-1521	HFBR-1531
1 MBd High Performance	R _x	HFBR-1522	HFBR-1532
40 kBd Low Current/ Extended Distance	R _x	HFBR-1523	HFBR-1533
1 MBd Standard	R _x	HFBR-1524	HFBR-1534

CONNECTORS

Page 5-30

HFBR-4501	Gray Simplex Connector/Crimp Ring
HFBR-4511	Blue Simplex Connector/Crimp Ring
HFBR-4503	Gray Simplex Latching Connector with Crimp Ring
HFBR-4513	Blue Simplex Latching Connector with Crimp Ring
HFBR-4506	Parchment Duplex Connector with Crimp Ring
HFBR-4516	Parchment Duplex Latching Connector with Crimp Ring
HFBR-4505	Gray Adapter
HFBR-4515	Blue Adapter

EVALUATION KIT, HFBR-0501

CONTENTS:

HFBR-1524	Transmitter
HFBR-2524	Receiver
HFBR-4501	Gray Simplex Connector with Crimp Ring
HFBR-4506	Duplex Connector with Crimp Ring
—	5 metres of Connected Simplex Cable with Blue Simplex and Gray Simplex Latching Connectors
HFBR-4513	Blue Simplex Latching Connector with Crimp Ring
HFBR-4505	Gray Adapter
—	Polishing Tool and 600 grit paper
HFBR-0501	Data Sheet and Brochure

ACCESSORIES

HFBR-4522	500 Port Plugs
HFBR-4525	1000 Simplex Crimp Rings
HFBR-4526	500 Duplex Crimp Rings
HFBR-4593	Polishing Kit (one polishing tool, two pieces 600 grit abrasive paper, and two pieces 3- μ m lapping film).
HFBR-4597	Crimping Tool

A Note About Ordering Cable

Four steps are required to determine the proper part number for a desired cable.

Step 1 Select Standard or Improved Cable.

As explained on page 5-29, two levels of attenuation are available: Standard and Improved.

Step 2 Select the connector style.

Connector styles are described on page 5-30.

Step 3 Select Simplex or Duplex.

Step 4 Determine the cable length.

To determine the appropriate part number, select the letter corresponding to your selection and fill in the following:

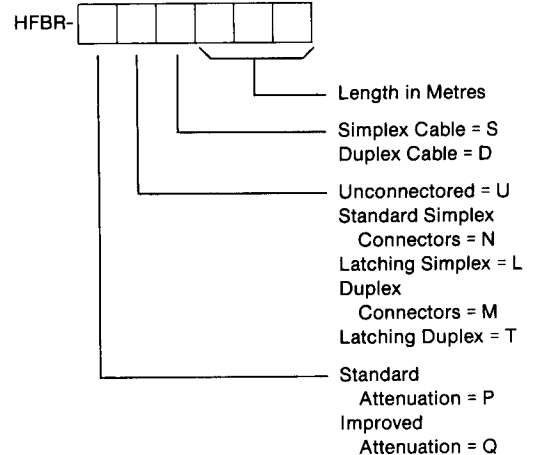

For example:

HFBR-PUD500 is a Standard Attenuation, Unconnected, Duplex, 500 metre cable.

HFBR-QLS001 is an Improved Attenuation, Latching Simplex Connected, Simplex, 1 metre cable.

HFBR-PMD010 is a Standard Attenuation, Standard Duplex Connected, Duplex, 10 metre cable.

HFBR-PND100 is a Standard Attenuation, Standard Simplex Connected, Duplex, 100 metre cable.

Note: 0.1 metre Standard Attenuation Simplex lengths are available; 0.5 metre Standard Attenuation Simplex and Duplex lengths are also available. The lengths are ordered as HFBR-xxx1DM or HFBR-xxx5DM.

ATTENTION: Pre-connected simplex cables have oppositely colored (GRAY vs. BLUE) connectors at the opposite ends of the same fiber; although oppositely colored, the connectors are mechanically identical. For duplex cables with simplex connectors, the same rule applies to each fiber; also, the side-by-side fibers at each end of the cable have oppositely colored connectors. For duplex cables with duplex connectors similar rules apply, so the connectors at opposite ends are oppositely keyed relative to the marked fiber in a duplex cable.