

HF140FF

MINIATURE INTERMEDIATE POWER RELAY



File No.:E134517



File No.:R50149131



File No.:CQC10002046173



Features

- 10A switching capability
- 5kV dielectric strength (between coil and contacts)
- Standard: Creepage distance >8mm
- 2.0mm contact gap available
- Sockets available
- Plastic sealed and flux proofed types available
- UL insulation system: Class F available

RoHS compliant

CONTACT DATA

Contact arrangement	2A, 2C
Contact resistance ¹⁾	50mΩ max.(at 1A 24VDC)
Contact material	AgSnO ₂ , AgNi, AgCdO
Contact rating (Res. load)	10A 250VAC 8A 30VDC
Max. switching voltage	250VAC / 30VDC
Max. switching current	10A
Max. switching power	2500VA / 240W
Mechanical endurance	Standard: 1 x 10 ⁷ OPS W type(1.5mm): 5 x 10 ⁵ OPS W type(2.0mm): 3 x 10 ⁵ OPS
Electrical endurance	2H: 1 x 10 ⁵ OPS (NO or NC, 10A 250VAC, Resistive load, Room temp., 1s on 9s off) 1 x 10 ⁵ OPS (NO or NC, 8A 30VDC, Resistive load, Room temp., 1s on 9s off)

Notes: 1) The data shown above are initial values.

2) For plastic sealed type, the venting-hole should be excised in electrical endurance test.

CHARACTERISTICS

Insulation resistance	1000MΩ (at 500VDC)	
Dielectric strength	Between coil & contacts	5000VAC 1min
	Between contacts sets	3000VAC 1min
	Between open contacts	Standard: 1000VAC 1min W type(1.5mm): 2000VAC 1min W type(2.0mm): 2500VAC 1min
Surge voltage (between coil & contacts)	10kV (1.2/50 μs)	
Operate time (at nomi. volt.)	15ms max.	
Release time (at nomi. volt.)	5ms max.	
Humidity	5% to 85% RH	
Ambient temperature	-40°C to 85°C	
Shock resistance	Functional	98m/s ²
	Destructive	980m/s ²
Vibration resistance	10Hz to 55Hz 1.5mmDA	
Termination	PCB	
Unit weight	Approx. 18g	
Construction	Plastic sealed, Flux proofed	

Notes: 1) The data shown above are initial values.

2) Please find coil temperature curve in the characteristic curves below.

3) UL insulation system: Class F, Class B.



HONGFA RELAY

ISO9001, ISO/TS16949, ISO14001, OHSAS18001, IECQ QC 080000 CERTIFIED

2018 Rev. 1.00

COIL

Coil power	Standard: Approx. 530mW
	W type(1.5mm): Approx. 800mW W type(2.0mm): Approx. 1.4W

COIL DATA

at 23°C

Standard type

Nominal Voltage VDC	Pick-up Voltage VDC max. ¹⁾	Drop-out Voltage VDC min. ¹⁾	Max. Voltage VDC ²⁾	Coil Resistance Ω
3	2.25	0.3	3.9	17 x (1±10%)
5	3.75	0.5	6.5	47 x (1±10%)
6	4.50	0.6	7.8	68 x (1±10%)
9	6.75	0.9	11.7	160 x (1±10%)
12	9.00	1.2	15.6	275 x (1±10%)
18	13.50	1.8	23.4	620 x (1±10%)
24	18.00	2.4	31.2	1100 x (1±10%)
48	36.00	4.8	62.4	4170 x (1±10%)
60	45.00	6.0	78.0	7000 x (1±10%)

Notes: 1) The data shown above are initial values.

2) Maximum voltage refers to the maximum voltage which relay coil could endure in a short period of time.

COIL DATA

at 23°C

W Type (1.5mm)

Nominal Voltage VDC	Pick-up Voltage VDC max. ²⁾	Drop-out Voltage VDC min. ²⁾	Max. Voltage VDC ³⁾	Coil Resistance Ω
3	2.25	0.3	3.3	11.3 x (1±10%)
5	3.75	0.5	5.5	31 x (1±10%)
6	4.50	0.6	6.6	45 x (1±10%)
9	6.75	0.9	9.9	101 x (1±10%)
12	9.00	1.2	13.2	180 x (1±10%)
18	13.5	1.8	19.8	405 x (1±10%)
24	18.0	2.4	26.4	720 x (1±10%)
48	36.0	4.8	52.8	2880 x (1±10%)
60	45.0	6.0	66.0	4500 x (1±10%)

W Type (2.0mm)

Nominal Voltage VDC	Pick-up Voltage VDC max. ²⁾	Drop-out Voltage VDC min. ²⁾	Max. Voltage VDC ³⁾	Coil Resistance Ω
5	3.75	0.5	5.5	18 x (1±10%)
6	4.50	0.6	6.6	26 x (1±10%)
9	6.75	0.9	9.9	58 x (1±10%)
12	9.00	1.2	13.2	102 x (1±10%)
24	18.0	2.4	26.4	410 x (1±10%)
48	36.0	4.8	52.8	1650 x (1±10%)

Notes: 1) When require pick-up voltage < 75% of nominal voltage, special order allowed.

2) The data shown above are initial values.

3) Maximum voltage refers to the maximum voltage which relay coil could endure in a short period of time.

4) Under ambient temperature, applying more than 80% of rating voltage to coil, relay will take action accordingly. But in order to meet the stated product performance, please apply rated voltage to coil.

5) For the CO version whose contact gap is 1.5 mm, the operation voltage ≤ 85% of rated voltage.

SAFETY APPROVAL RATINGS

UL/CUL	Standard	AgCdO	TV-3 125VAC 10A 250VAC 10A 30VDC 1/4HP 240VAC 1/8HP 120VAC	
		AgNi	10A 250VAC 10A 30VDC 12A 277VAC/250VAC Resistive at 70°C 1/3HP 125VAC at 40°C	
		AgSnO ₂	2 Form A	10A 250VAC 10A 30VDC 12A 277VAC/250VAC Resistive at 70°C 1/3HP 125VAC at 40°C 3/4HP 250VAC at 40°C
			2 Form C	10A 250VAC 10A 30VDC 12A 277VAC/250VAC Resistive at 70°C 1/3HP 125VAC at 40°C 3/4HP 250VAC at 40°C
	W type	AgCdO	2 Form A	TV-3 125VAC 10A 250VAC
		AgSnO ₂	2 Form A	12A 277VAC/250VAC Resistive at 70°C 1/3HP 125VAC at 40°C 3/4HP 250VAC at 40°C
TÜV		AgCdO	2 Form A	10A 250VAC
			2 Form C	10A 30VDC
		AgNi	2 Form A	12A 250VAC
			2 Form C	10A 250VAC
AgSnO ₂	2 Form A	12A 250VAC		

Notes: 1) All values unspecified are at room temperature.

2) Only typical loads are listed above. Other load specifications can be available upon request.

ORDERING INFORMATION

Type	HF140FF/ 012 -2H S W T G F (XXX)						
Coil voltage	3, 5, 6, 9, 12, 18, 24, 48, 60VDC						
Contact arrangement	2H: 2 Form A 2Z: 2 Form C						
Construction ¹⁾²⁾	S: Plastic sealed(No smoky-gray cover) Nil: Flux proofed						
Contact Gap	W: Large contact gap ³⁾			Nil: Standard			
Contact material	T: AgSnO ₂ 3: AgNi		Nil: AgCdO				
Contact plating	G: Gold plated		Nil: No gold plated				
Insulation standard	F: Class F		Nil: Class B				
Special code ⁵⁾	XXX: Customer special requirement			Nil: Standard			

- Notes:1) We recommend flux proofed types for a clean environment (free from contaminations like H₂S, SO₂, NO₂, dust, etc.). We suggest to choose plastic sealed types and validate it in real application for an unclean environment (with contaminations like H₂S, SO₂, NO₂, dust, etc).
- 2) Contact is recommended for suitable condition and specifications if water cleaning or surface process is involved in assembling relays on PCB.
- 3) There are two specifications to W type: 1.5mm contact gap and 2.0mm contact gap. The default W type is 1.5mm. So please add the special code "(456)" when releasing order, if 2.0mm contact gap is required. (Only for 2 Form A).
- 4) The standard type is made of black cover. If smoke cover is required, please add a special suffix when ordering. Please take note that smoky-gray cover is only available for flux proofed types.
- 5) The customer special requirement express as special code after evaluating by Hongfa. e.g.(456) means contact gap can reach 2.0mm.

OUTLINE DIMENSIONS, WIRING DIAGRAM AND PC BOARD LAYOUT

Unit: mm

Outline Dimensions

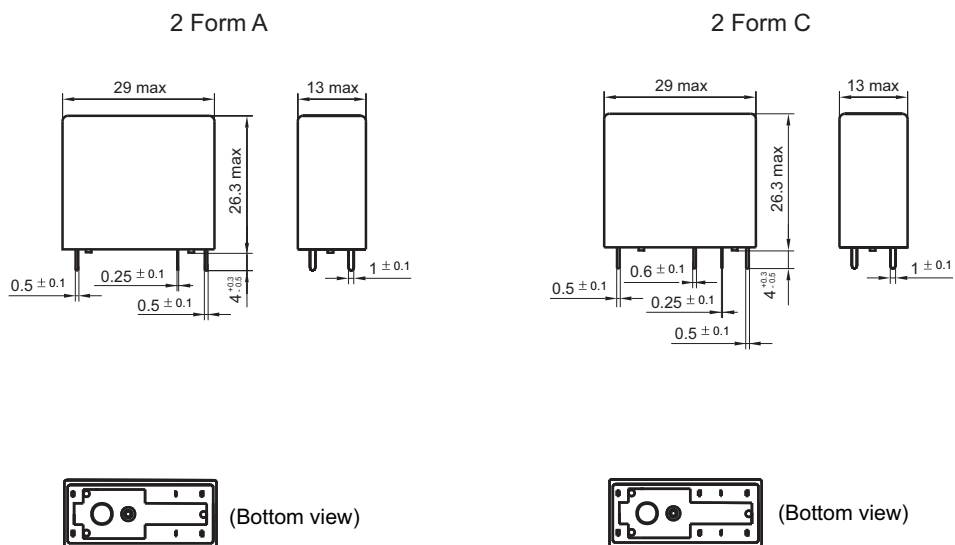

Wiring Diagram (Bottom view)



PCB Layout (Bottom view)

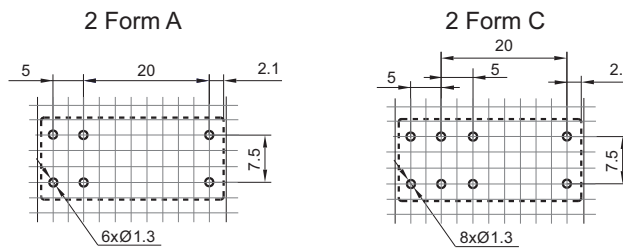

- Remark: 1) In case of no tolerance shown in outline dimension: outline dimension $\leq 1\text{mm}$, tolerance should be $\pm 0.2\text{mm}$; outline dimension $> 1\text{mm}$ and $\leq 5\text{mm}$, tolerance should be $\pm 0.3\text{mm}$; outline dimension $> 5\text{mm}$, tolerance should be $\pm 0.4\text{mm}$.
 2) The tolerance without indicating for PCB layout is always $\pm 0.1\text{mm}$.
 3) The width of the gridding is 2.5mm.

CHARACTERISTIC CURVES

MAXIMUM SWITCHING POWER

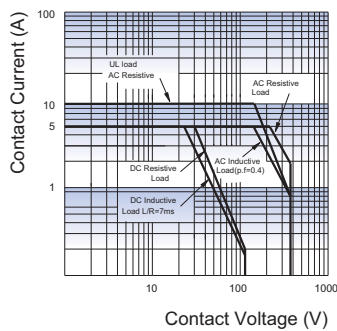

ENDURANCE CURVE

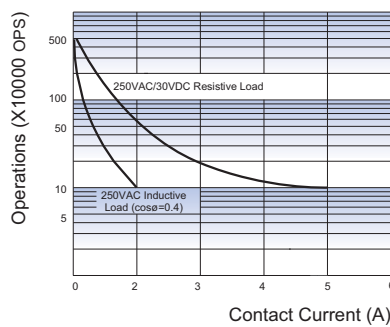

COIL TEMPERATURE RISE

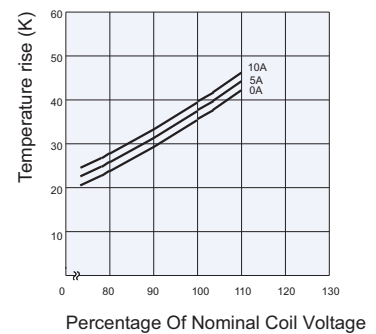

Test conditions:
 NO, Resistive load, Flux proofed,
 Room temp., 1s on 9s off.

Relay Sockets

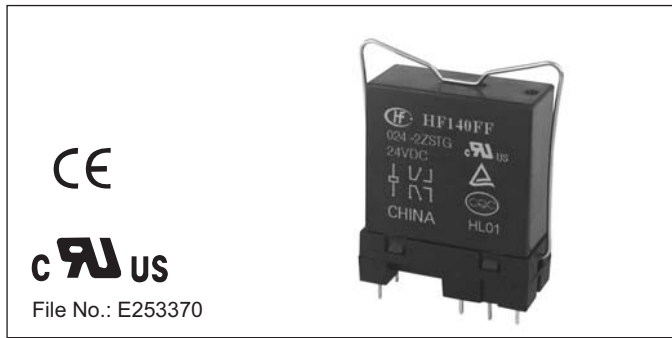

Features





- The insulation resistance is 1000MΩ
- Three mounting types are available: PCB, screw mounting and DIN rail mounting
- With finger protection device
- Many kinds of plug-in modules are available with the function of energizing indication and wiring protection
- Environmental friendly product (RoHS compliant)

CHARACTERISTICS

Type	Nominal Voltage	Nominal Current	Ambient Temperature	Dielectric Strengths	Screw Torque	Wire Strip Length
14FF-2Z-A1	250VAC	10A	-40 °C to 70 °C	5000VAC	—	—
14FF-2Z-C2	250VAC	10A	-40 °C to 70 °C	5000VAC	0.6N · m	7mm
14FF-2Z-C3	250VAC	10A	-40 °C to 70 °C	5000VAC	0.6N · m	7mm
14FF-2Z-C4	250VAC	10A	-40 °C to 70 °C	5000VAC	—	9mm

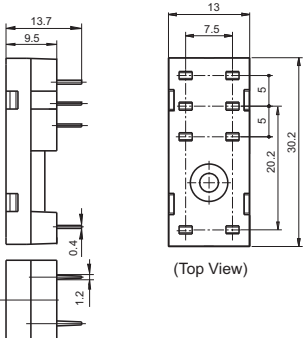
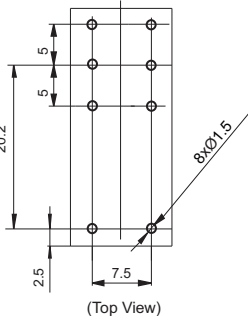
OUTLINE DIMENSIONS, WIRING DIAGRAM AND PC BOARD LAYOUT

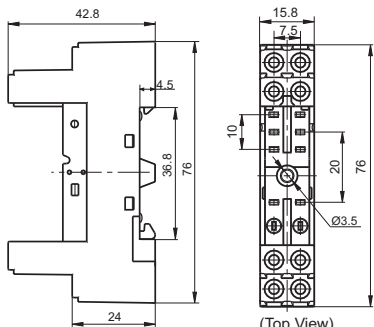
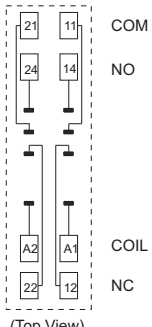
Unit: mm

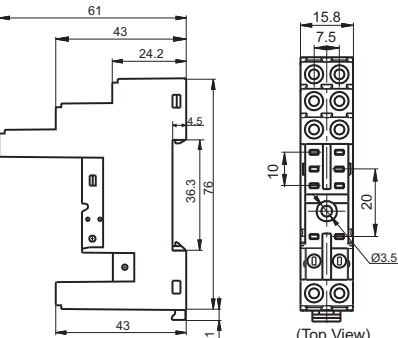
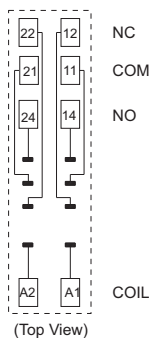
Socket	Outline Dimensions	Wiring Diagram / PCB Layout	Components Available
<p>14FF-2Z-A1</p>  <p>PCB terminal, PCB or Screw mounting</p>	 <p>(Top View)</p>	 <p>(Top View)</p>	<p>metallic retainer 14FF-H3</p> <p>remarks:the dielectric strength can reach 1500VAC that sockets mounted 14FF-H3</p>
<p>14FF-2Z-C2</p>  <p>Screw terminal DIN rail or Screw mounting With finger protection device</p>	 <p>(Top View)</p>	 <p>(Top View)</p>	<p>plastic retainer 14FF-H6</p> <p>marker 14FF-M1</p> <p>plug-in module HFAA to HFHU*</p>
<p>14FF-2Z-C3</p>  <p>Screw terminal DIN rail or Screw mounting With finger protection device</p>	 <p>(Top View)</p>	 <p>(Top View)</p>	<p>plastic retainer 14FF-H6</p> <p>marker 14FF-M1</p> <p>plug-in module HFAA to HFHU*</p>

OUTLINE DIMENSIONS, WIRING DIAGRAM AND PC BOARD LAYOUT

Unit: mm

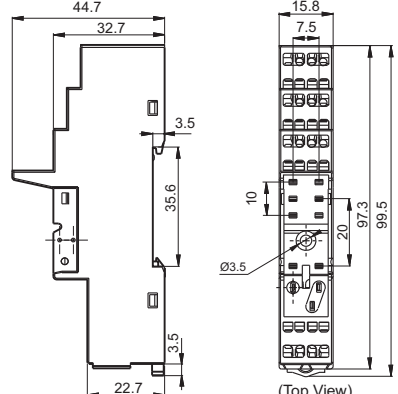
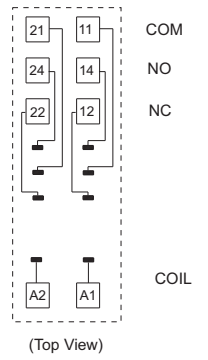
Socket	Outline Dimensions	Wiring Diagram / PCB Layout	Components available
14FF-2Z-C4  Spring-loaded terminal DIN rail mounting With finger protection device	 <p>(Top View)</p>	 <p>(Top View)</p>	plastic retainer 14FF-H6 marker 14FF-M1 plug-in module HFAA to HFHU*

Notes: * Please refer to the product datasheet if plug-in module is required.

DIMENSION OF RELATED COMPONENT (AVAILABLE)

Unit: mm

Retainer

14FF-H3(Metallic retainer)

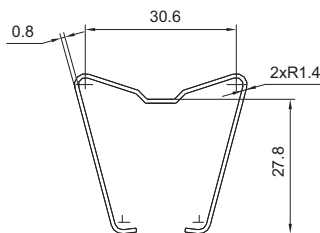

14FF-H6(Plastic retainer)

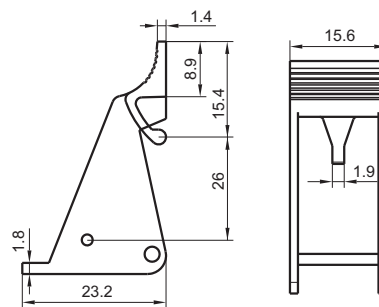

Marker

14FF-M1

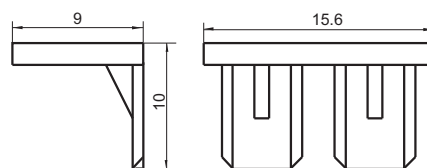

Things to be noticed when selecting sockets:

1. Please choose suitable relay socket according to the actual mounting environment, relay contact poles and terminal layout. If there is any query on selection, please contact Hongfa for the technical service.
2. Socket which can be mounted with markers is furnished with a marker; as for other related components, they should be selected separately. Please do give clear indication of the types of relay sockets and related components you choose while placing order.
3. The above is only an example of typical socket and related component type which is suitable to HF140FF relay. If you have any special requirements, please contact us.
4. Main outline dimension, outline dimension $> 50\text{mm}$, tolerance should be $\pm 1\text{mm}$; $20\text{mm} < \text{outline dimension} \leq 50\text{mm}$, tolerance should be $\pm 0.5\text{mm}$; $5\text{mm} < \text{outline dimension} \leq 20\text{mm}$, tolerance should be $\pm 0.4\text{mm}$; outline dimension $\leq 5\text{mm}$, tolerance should be $\pm 0.3\text{mm}$.
5. DIN rail mounting: recommend to use standard rail $35 \times 7.5 \times 1\text{mm}$, $35 \times 15 \times 1\text{mm}$.

Disclaimer

The specification is for reference only. See to "Terminology and Guidelines" for more information. Specifications subject to change without notice. We could not evaluate all the performance and all the parameters for every possible application. Thus the user should be in a right position to choose the suitable product for their own application. If there is any query, please contact Hongfa for the technical service. However, it is the user's responsibility to determine which product should be used only.

© Xiamen Hongfa Electroacoustic Co., Ltd. All rights of Hongfa are reserved.