

880111088
(ON ENIMVARD) 台架理図

版数 VER.	年月日 DATE	CN NO.	変更内容 DESCRIPTION	製図 DR.	担当 CHK.	査閲 APPD.	承認 APPD.
2	6.Sep.2013	007507	INSULATOR OUTLINE CHANGED		J.SHINDOU	T.YAMAJI	K.IBARAKI

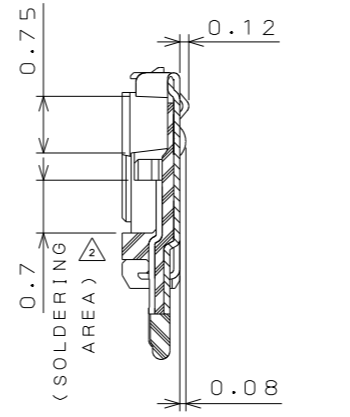

SECT. A-A
(SCALE 10:1)

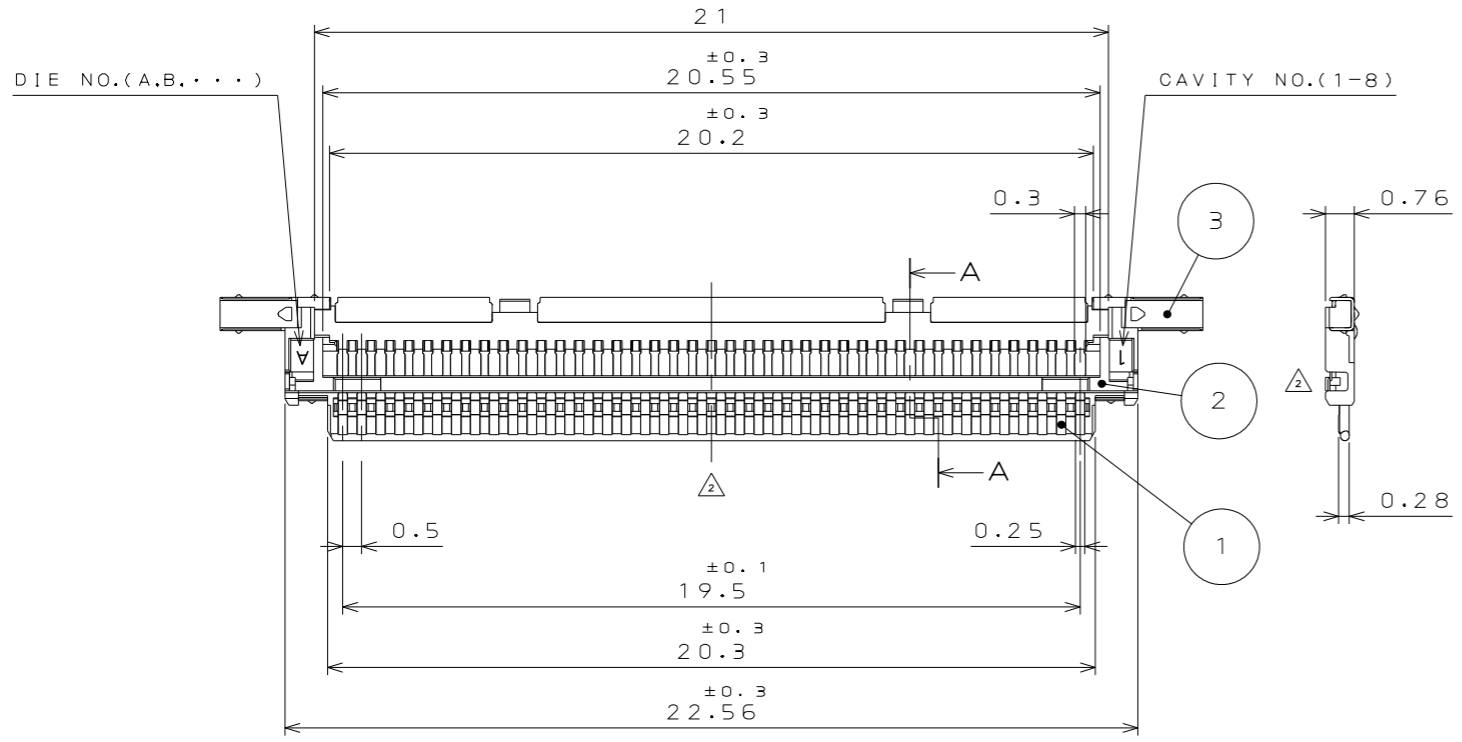
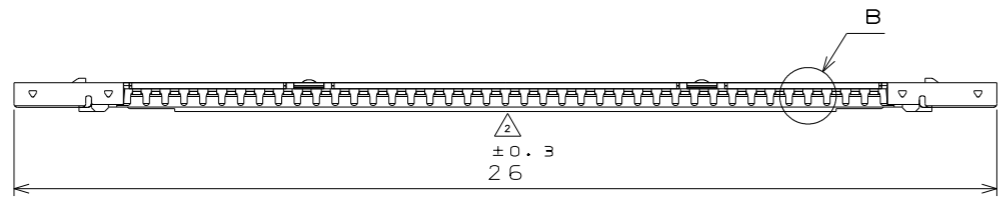
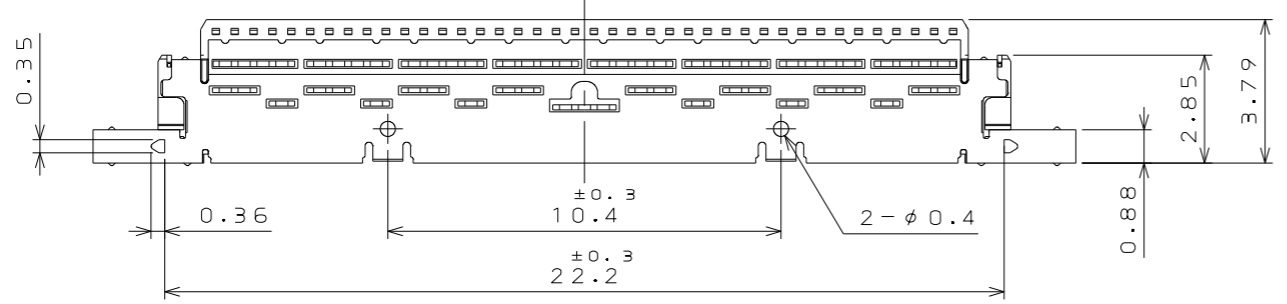
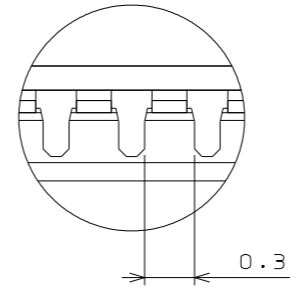

DETAIL B
(SCALE 20:1)

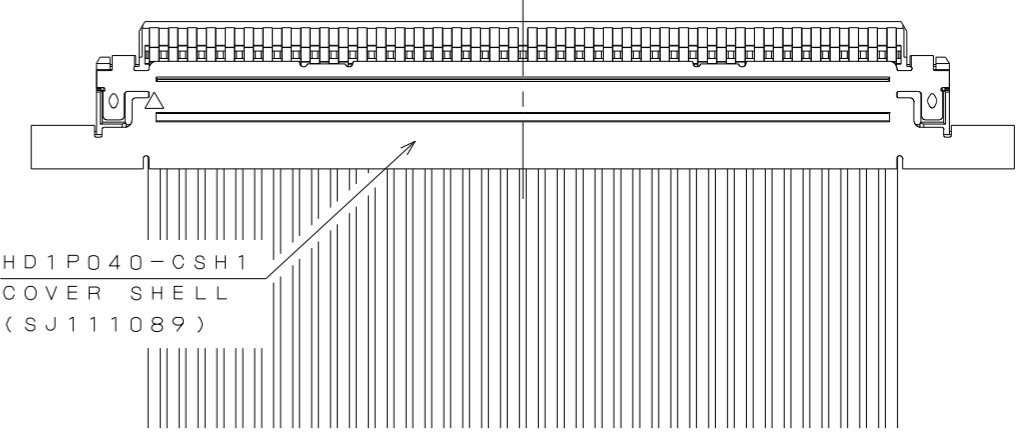

CABLE ASSEMBLED CONDITION (REF.)
ケーブル組立状態図(参考)

DESIGNATION
命名法

HD1P040MA1
 HD1: SERIES
 P: PLUG TYPE
 040: NO. OF CONTACT
 M: FORM OF TERMINAL
 A: PLATING SPECIFICATION OF CONTACT AND TERMINAL AREA
 1: MODIFICATION CODE

3	BASE SHELL ベースシェル	1	COPPER ALLOY 銅合金	GOLD(0.03μm Min.) OVER NICKEL Ni上Auめっき(0.03μm以上)	
2	INSULATOR インシュレータ	1	HEAT RESISTING PLASTIC 耐熱性プラスチック		COLOR:BLACK 色相:黒
1	CONTACT コンタクト	40	COPPER ALLOY 銅合金	CONTACT AREA:GOLD(0.1μmMIN)OVER NICKEL TERMINAL AREA:GOLD(0.1μmMIN)OVER NICKEL	
符号 NO.	名称 DESCRIPTION	個数 QTY.	材料 MATERIAL	仕上 FINISH	備考 REMARKS
仕様書 (SPECIFICATION) JACS-10696 JAHL-10696-1 JAHL-10696-2		第1版 (ORIGINAL DATE) 30.Mar.2011		尺度 (SCALE) 5:1	シリーズ (SERIES) HD1
一般公差 (GENERAL TOLERANCE)		製図 DR.		名称 (TITLE) HD1P040MA1	
寸法 (DIMENSION)		担当 CHK.	J.SHINDOU	日本航空電子工業株式会社 JAPAN AVIATION ELECTRONICS INDUSTRY, LTD.	
角度 (ANGLES)		査閲 APPD.	M.KIMURA		
.x } ±0.2 .xx } .xxx }		承認 APPD.	K.IBARAKI		
		単位 (UNIT): mm		質量 (MASS)	図面番号 (DRAWING NO.) SJ111088

LICENSED BY DAI-ICHI SEIKO CO.,LTD.

DCF-C-212H(12.08)

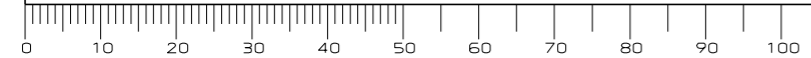

WISDOM承認 2013/09/30

SIZE A3
版数 (VER.) 2