

H82K05BYA ✓ ACTIVE

Holsworthy | Holsworthy Holco

TE Internal #: 2-1879664-5

Precision Resistor, Thin Film, .25 W, 2.05K Ω , .1 %, ± 15 ppm/ $^{\circ}\text{C}$, Axial-Leaded, Copper Termination, 7.2 x 2.5 mm, Bandoliered, Holsworthy Holco

[View on TE.com >](#)



Passive Components > Resistors > Through-Hole Resistors



Resistor Type: **Precision Resistor**

Element Type: **Thin Film**

Power Rating: **.25 W**

Resistance Class: **1k Ω - 1M Ω**

Resistance Value: **2.05K Ω**

Features

Product Type Features

Resistor Type	Precision Resistor
Element Type	Thin Film

Configuration Features

Number of Resistors	1
---------------------	---

Electrical Characteristics

Operating Voltage	350 V
Power Rating	.25 W
Resistance Class	1k Ω - 1M Ω
Resistance Value	2.05K Ω
Passive Component Tolerance	.1 %

Body Features

Lead Type	Axial-Leaded
-----------	--------------

Termination Features

Termination Area Base Material	Copper
Number of Terminations	2

Dimensions

Passive Component Dimensions	7.2 x 2.5 mm
------------------------------	--------------



Usage Conditions

Operating Temperature Range	-55 - 155 $^{\circ}\text{C}$
Temperature Coefficient	± 15 ppm/ $^{\circ}\text{C}$

Packaging Features

Packaging Method	Bandoliered
------------------	-------------

Product Compliance

[For compliance documentation, visit the product page on TE.com>](#)

EU RoHS Directive 2011/65/EU	Compliant
EU ELV Directive 2000/53/EC	Compliant
China RoHS 2 Directive MIIT Order No 32, 2016	No Restricted Materials Above Threshold
EU REACH Regulation (EC) No. 1907/2006	Current ECHA Candidate List: JAN 2024 (240) Candidate List Declared Against: JAN 2021 (211) Does not contain REACH SVHC
Halogen Content	Not Yet Reviewed for halogen content
Solder Process Capability	Wave solder capable to 265 $^{\circ}\text{C}$

Product Compliance Disclaimer

This information is provided based on reasonable inquiry of our suppliers and represents our current actual knowledge based on the information they provided. This information is subject to change. The part numbers that TE has identified as EU RoHS compliant have a maximum concentration of 0.1% by weight in homogenous materials for lead, hexavalent chromium, mercury, PBB, PBDE, DBP, BBP, DEHP, DIBP, and 0.01% for cadmium, or qualify for an exemption to these limits as defined in the Annexes of Directive 2011/65/EU (RoHS2). Finished electrical and electronic equipment products will be CE marked as required by Directive 2011/65/EU. Components may not be CE marked. Additionally, the part numbers that TE has identified as EU ELV compliant have a maximum concentration of 0.1% by weight in homogenous materials for lead, hexavalent chromium, and mercury, and 0.01% for cadmium, or qualify for an exemption to these limits as defined in the Annexes of Directive 2000/53/EC (ELV). Regarding the REACH Regulation, the information TE provides on SVHC in articles for this part number is based on the latest European Chemicals Agency (ECHA) 'Guidance on requirements for substances in articles' posted at this URL: <https://echa.europa.eu/guidance-documents/guidance-on-reach>

Compatible Parts

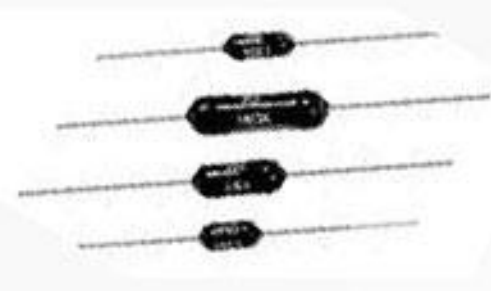

TE Part # 9-1879664-1
H8 10K 0.1% 15PPM



TE Part # 1879623-8
H4 1K3 0.1% 5PPM

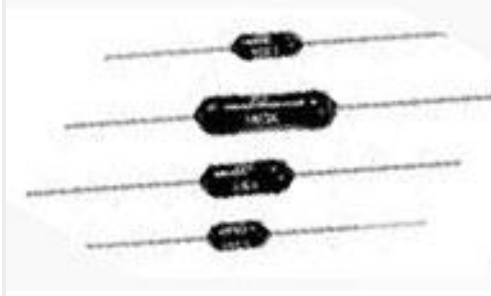

TE Part # 2-1879622-2
H4P 1M0 1% 50PPM

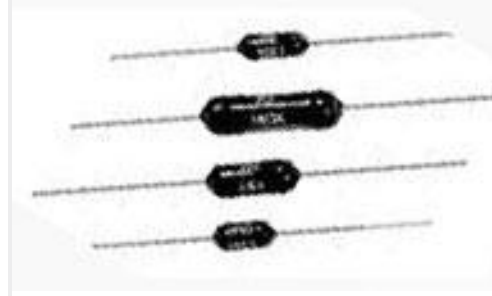

TE Part # 5-1879642-1
H8 5K0 0.1% 25PPM

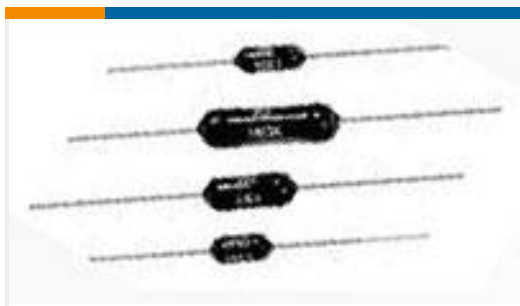

TE Part # 1879629-8
H4P 127R 0.5% 5PPM

Also in the Series | Holsworthy Holco



Through-Hole Resistors(6406)

Customers Also Bought



TE Part # 281698-4
HEADER HE14 RA 4 P

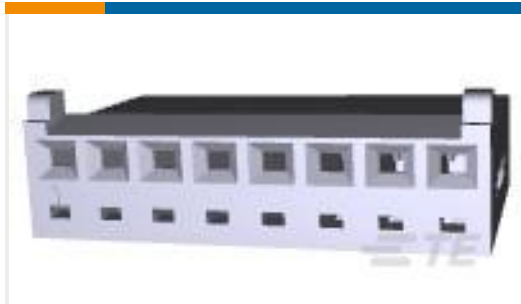

TE Part # 1375820-8
CST-100 II HOUSING 8 POS

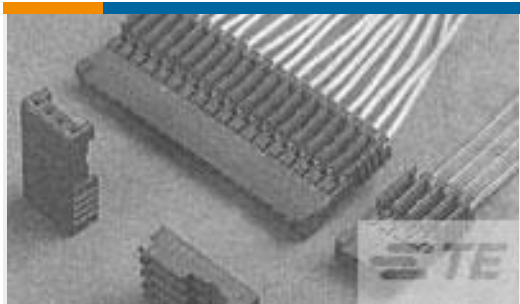

TE Part # 281784-4
PLUG HE13 IDC 180 4 P AWG 26-24



TE Part # 130550
SOLIS 8 R M6



TE Part # 160013
SOLIS 8 R M5



TE Part # 3-640429-4
04P MTA156 CONN ASSY 24AWG
WHT

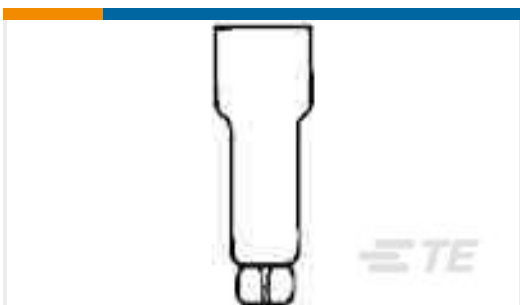

TE Part # 36964
SPLICE,CE 22-14

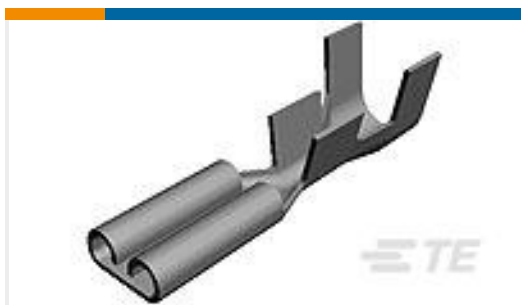

TE Part # 41829-1
250 FASTON REC 14-12 AWG TPBR



TE Part # 1879026-4
YR1 0.1% 10R



TE Part # 1534807-1
HD20 COVER KIT 15P



Documents

CAD Files

3D PDF

3D

Customer View Model

[ENG_CVM_CVM_2-1879664-5_BA.2d_dxf.zip](#)

English

Customer View Model

[ENG_CVM_CVM_2-1879664-5_BA.3d_igs.zip](#)

English

Customer View Model

[ENG_CVM_CVM_2-1879664-5_BA.3d_stp.zip](#)

English

By downloading the CAD file I accept and agree to the [Terms and Conditions](#) of use.

Datasheets & Catalog Pages

[1309350_PASSIVE_COMPONENT](#)

English

[Axial Leaded Precision Resistors - Type HOLCO Series](#)

English

[8-1773459-4_POWER_FILTERING_AND_RESISTIVE_SOLUTIONS_FOR_ELEVATORS_AND_ESCALATORS](#)

English