



Main

| | |
|---------------------------|--------------------------|
| Range of product | TeSys GV4 |
| Range | TeSys Deca TeSys Deca |
| Device short name | GV4L |
| Product name | TeSys GV4 TeSys Deca |
| Product or component type | Motor circuit breaker |
| Device application | Motor protection |
| Trip unit technology | Magnetic Electronic |

Complementary

| | |
|---|--|
| Poles description | 3P |
| Utilisation category | Category A conforming to IEC 60947-2 AC-3 conforming to IEC 60947-4-1 |
| Operating position | Any position |
| Motor power kW | 37 kW at 400...415 V AC 50/60 Hz 45 kW at 500 V AC 50/60 Hz 55 kW at 500 V AC 50/60 Hz 22 kW at 400...415 V AC 50/60 Hz 30 kW at 500 V AC 50/60 Hz 37 kW at 660...690 V AC 50/60 Hz 45 kW at 660...690 V AC 50/60 Hz 55 kW at 660...690 V AC 50/60 Hz 30 kW at 400...415 V AC 50/60 Hz 37 kW at 500 V AC 50/60 Hz |
| Breaking capacity | 120 KA Icu at 220...240 V AC 50/60 Hz conforming to IEC 60947-2 100 KA Icu at 380...415 V AC 50/60 Hz conforming to IEC 60947-2 70 KA Icu at 440 V AC 50/60 Hz conforming to IEC 60947-2 30 KA Icu at 500 V AC 50/60 Hz conforming to IEC 60947-2 18 KA Icu at 525 V AC 50/60 Hz conforming to IEC 60947-2 10 KA Icu at 660...690 V AC 50/60 Hz conforming to IEC 60947-2 |
| Control type | Toggle |
| [In] rated current | 80 A |
| Magnetic tripping current | 480...1120 A |
| [Ue] rated operational voltage | 690 V AC 50/60 Hz conforming to IEC 60947-2 |
| [Ui] rated insulation voltage | 800 V AC 50/60 Hz conforming to IEC 60947-2 |
| [Ith] conventional free air thermal current | 115 A conforming to IEC 60947-4-1 |
| [Uimp] rated impulse withstand voltage | 8 kV conforming to IEC 60947-2 |
| Power dissipation per pole | 6.1 W |
| Mechanical durability | 40000 cycles |
| Electrical durability | 14000 Cycles for AC-3 at 440 V In 7000 cycles for AC-3 at 440 V In |
| Maximum operating rate | 25 cyc/h |
| Rated duty | Continuous conforming to IEC 60947-4-1 |
| Connections - terminals | EverLink BTR screw connectors (top) 1 cable(s) 1.5...70 mm ² - solid EverLink BTR screw connectors (top) 1 cable(s) 1.5...50 mm ² - flexible EverLink BTR screw connectors (bottom) 1 cable(s) 2.5...95 mm ² - solid EverLink BTR screw connectors (bottom) 1 cable(s) 2.5...70 mm ² - flexible |
| Tightening torque | 9 N.M for cable 16...95 mm ² 5 N.m for cable 1.5...10 mm ² |

The information provided in this documentation contains general descriptions and/or technical characteristics of the products contained herein. This documentation is not intended as a substitute for and is not to be used for determining suitability or reliability of these products for specific user applications. It is the duty of any such user or integrator to perform the appropriate and complete risk analysis, evaluation and testing of the products with respect to the relevant specific application or use thereof. Neither Schneider Electric Industries SAS nor any of its affiliates or subsidiaries shall be responsible or liable for misuse of the information contained herein.

| | |
|---------------------------|--|
| Mechanical robustness | Vibrations: +/- 1 mm 2...13.2 Hz conforming to IEC 60068-2-6 Vibrations: 0.7 gn 13.2...100 Hz conforming to IEC 60068-2-6 Shocks: 15 gn 11 ms conforming to IEC 60068-2-27 |
| Height | 155 mm |
| Width | 81 mm |
| Depth | 116 mm |
| Net weight | 1.5 kg |
| Colour | Grey (RAL 7016) |
| Suitability for isolation | Yes conforming to IEC 60947-1 |

Environment

| | |
|---------------------------------------|-------------------------------------|
| Standards | EN/IEC 60947-4-1 EN/IEC 60947-2 |
| Product certifications | IEC CCC EAC EU-RO MR |
| Climatic withstand | Conforming to IACS E10 |
| IK degree of protection | IK07 conforming to IEC 62262 |
| Pollution degree | 3 |
| IP degree of protection | IP40 conforming to IEC 60529 |
| Ambient air temperature for storage | -50...85 °C |
| Fire resistance | 960 °C conforming to IEC 60695-2-11 |
| Operating altitude | 5000 m |
| Ambient air temperature for operation | -25...70 °C |

Packing Units

| | |
|------------------------------|----------|
| Unit Type of Package 1 | PCE |
| Number of Units in Package 1 | 1 |
| Package 1 Height | 16.6 cm |
| Package 1 Width | 10.9 cm |
| Package 1 Length | 22.0 cm |
| Package 1 Weight | 1.727 kg |
| Unit Type of Package 2 | S03 |
| Number of Units in Package 2 | 5 |
| Package 2 Height | 30.0 cm |
| Package 2 Width | 30.0 cm |
| Package 2 Length | 40.0 cm |
| Package 2 Weight | 8.65 kg |

Offer Sustainability

| | |
|-----------------------------|---|
| Sustainable offer status | Green Premium product |
| REACH Regulation | REACH Declaration |
| EU RoHS Directive | Compliant EU RoHS Declaration |
| Mercury free | Yes |
| China RoHS Regulation | China RoHS Declaration |
| RoHS exemption information | Yes |
| Environmental Disclosure | Product Environmental Profile |
| Circularity Profile | End Of Life Information |
| WEEE | The product must be disposed on European Union markets following specific waste collection and never end up in rubbish bins |
| PVC free | Yes |
| Halogen content performance | Halogen free plastic parts product |

Contractual warranty

| | |
|----------|-----------|
| Warranty | 18 months |
|----------|-----------|

Tripping Curves for GV4L and GV4LE Combined with Thermal Overload Relay LRD or LR9

Average Operating Times at 20 °C Related to Multiples of the Setting Current

GV4L02 and GV4LE02 to 12 with LRD05 to LRD14, GV4L80 and GV4LE80 with LRD3363

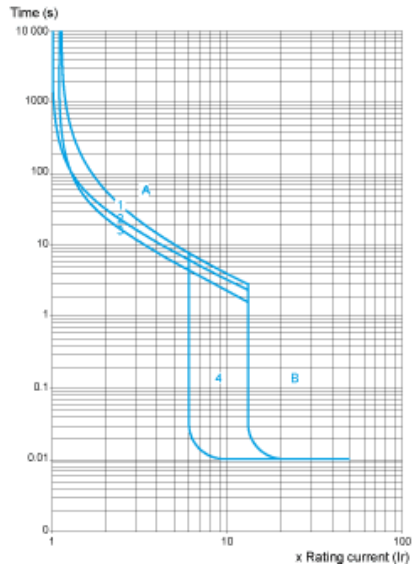

- 1 3 poles from cold state
- 2 2 poles from cold state
- 3 3 poles from hot state
- 4 6...14 Ir
- A Thermal overload relay protection zone
- B GV4L protection zone

GV4L25 and GV4LE25 with LRD 318, LRD325 GV4L50 AND GV4LE50 with LRD 332, LRD 340, LRD 350

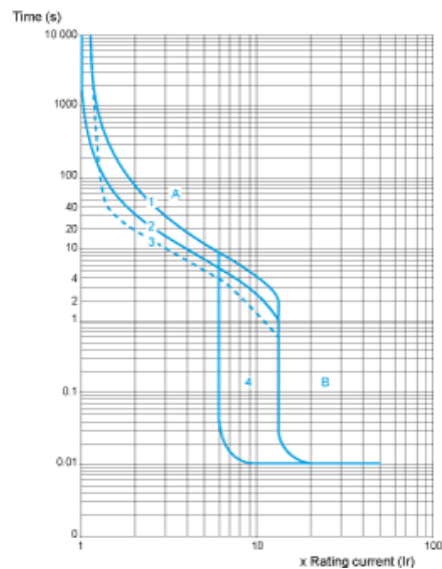

- 1 3 poles from cold state
- 2 2 poles from cold state
- 3 3 poles from hot state
- 4 6...14 Ir
- A Thermal overload relay protection zone
- B GV4L protection zone

GV4L115 and GV4LE115 with Class 10 LR9F5367, LR9D5369 and Class 20 LR9D5567, LR9F5569

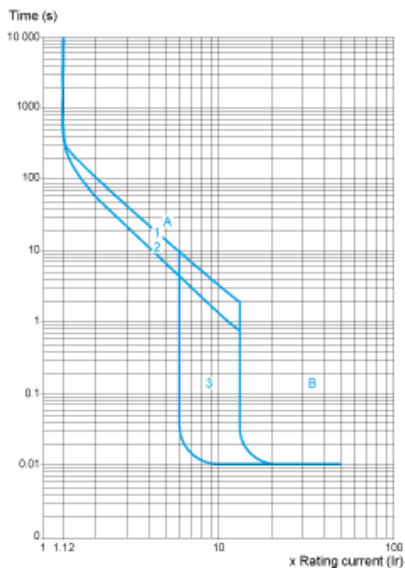

- 1 Cold state curve
- 2 Hot state curve
- 3 6...14 Ir

Current Limitation on Short-Circuit for GV4L, GV4LE (3-Phase 400/415 V)

Dynamic Stress

$I_{peak} = f(\text{prospective } I_{sc}) \text{ at } 1.05 U_e = 435 \text{ V}$

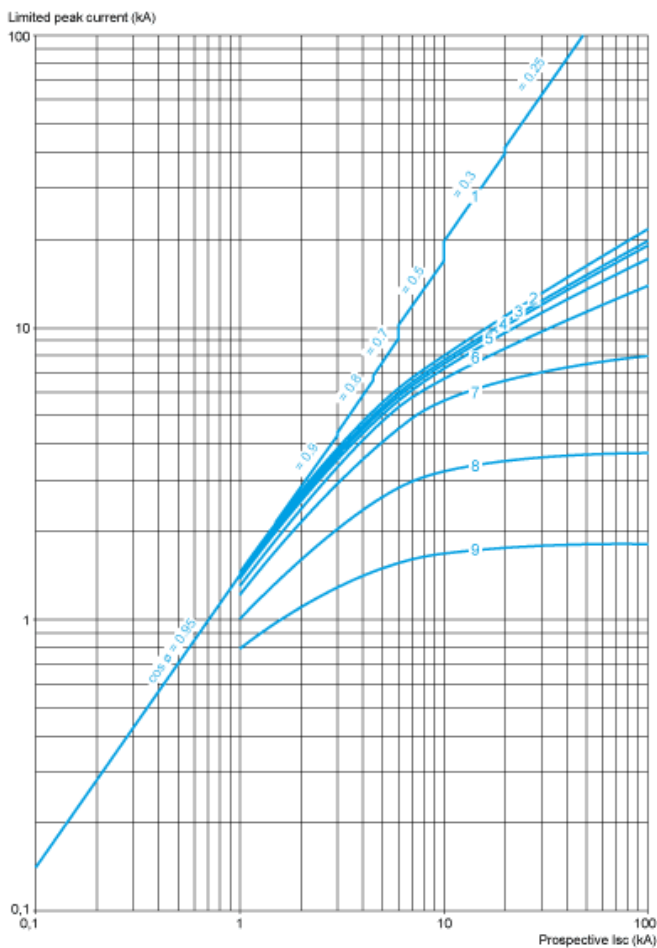

- 1 Maximum peak current
- 2 GV4L115
- 3 GV4L80
- 4 GV4L50
- 5 GV4L25
- 6 GV4L12
- 7 GV4L07
- 8 GV4L03
- 9 GV4L02

Current Limitation on Short-Circuit for GV4L, GV4LE + Thermal Overload Relay LRD or LR9 (3-Phase 400/415 V)

Dynamic Stress

$I_{peak} = f(\text{prospective } I_{sc})$ at $1.05 U_e = 435 \text{ V}$

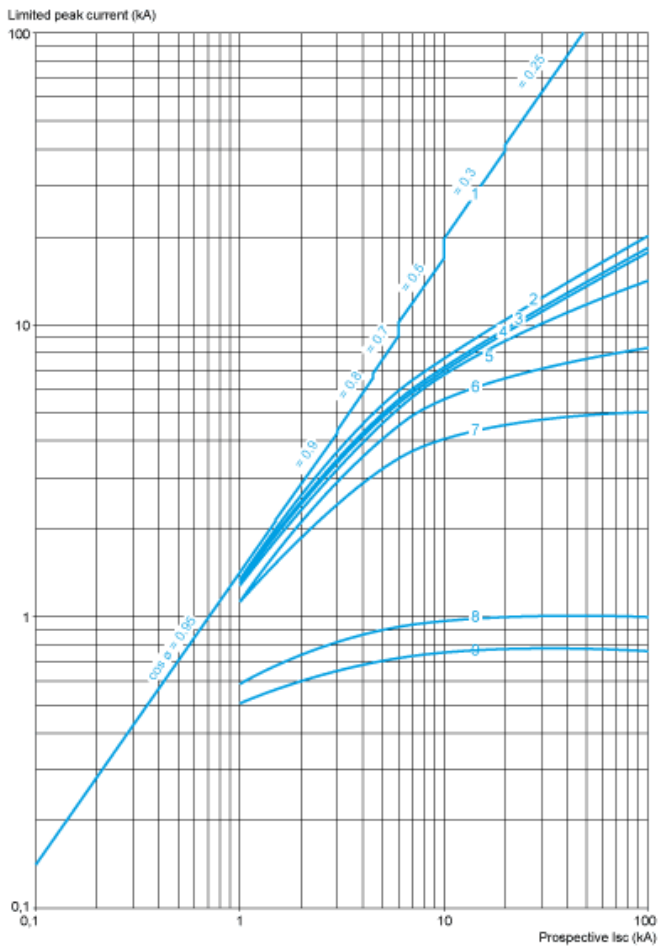

- 1 Maximum peak current
- 2 GV4L115 + LR9D5367 or LR9F5367
- 3 GV4L80 + LRD3361
- 4 GV4L50 + LRD340
- 5 GV4L25 + LRD325
- 6 GV4L12 + LRD313
- 7 GV4L07 + LRD12
- 8 GV4L03 + LRD07
- 9 GV4L02 + LRD07

Thermal Limit on Short-Circuit for GV4L, GV4LE

Thermal Limit in A^2s

Sum of $I^2dt = f(\text{prospective } I_{sc})$ at $1.05 U_e = 435 \text{ V}$

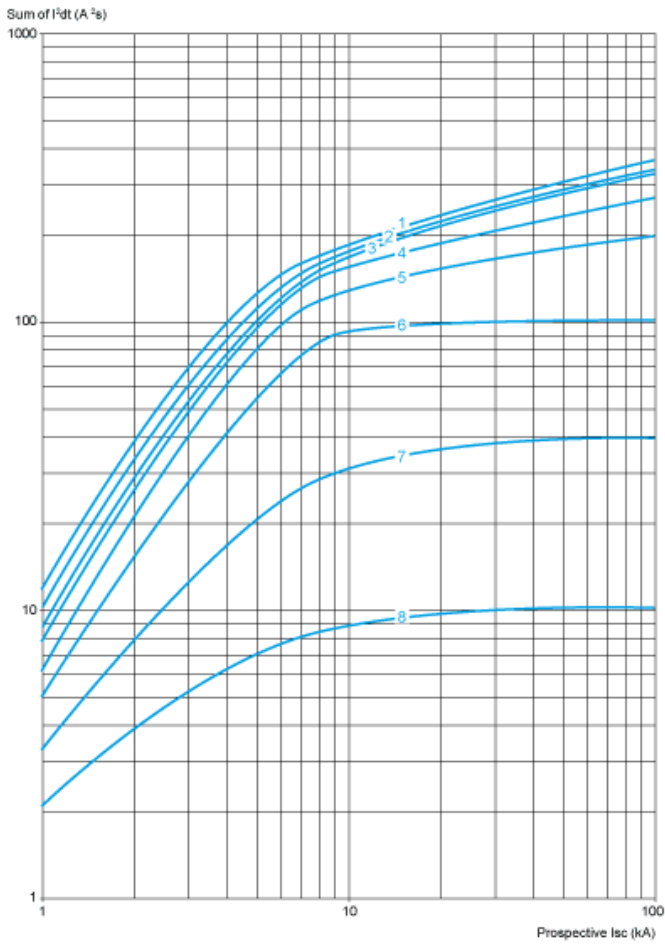

- 1 GV4L115
- 2 GV4L80
- 3 GV4L50
- 4 GV4L25
- 5 GV4L12
- 6 GV4L07
- 7 GV4L03
- 8 GV4L02

Current Limitation on Short-Circuit for GV4L, GV4LE + Thermal Overload Relay LRD or LR9

Thermal Limit in kA in the Magnetic Operating Zone

Sum of $I^2dt = f$ (prospective Isc) at $1.05 U_e = 435 V$

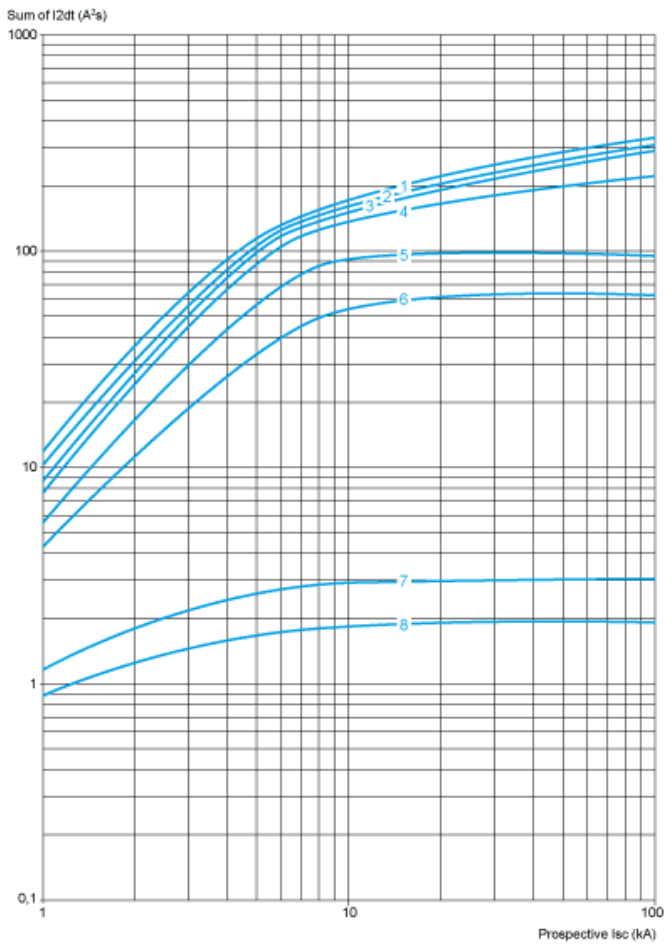

- 1 GV4L115 + LR9D5367 or LR9F5367
- 2 GV4L80 + LRD3361
- 3 GV4L50 + LRD340
- 4 GV4L25 + LRD325
- 5 GV4L12 + LRD313
- 6 GV4L07+ LRD12
- 7 GV4L03+ LRD07
- 8 GV4L02 + LRD07

GV4 with Toggle: GV4LE, GV4PE, GV4PEM

With EverLink® Connector

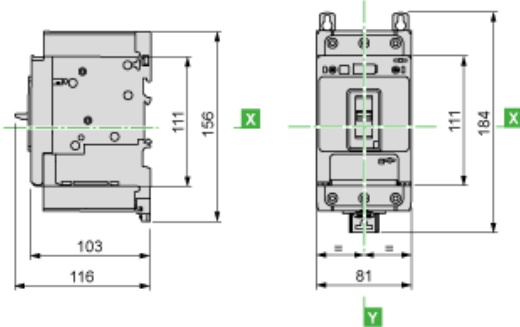

With Crimp Lug Connector

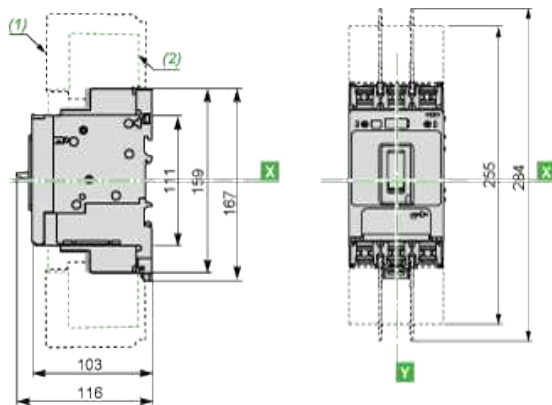

- (1) Interphases barriers
- (2) Long terminal shield

GV4 with Rotary Handle: GV4L, GV4P, or GV4LE, GV4PE, GV4PEM with GV4ADN01, GV4ADN02 Direct Mounting Rotary Handle

Dimensions

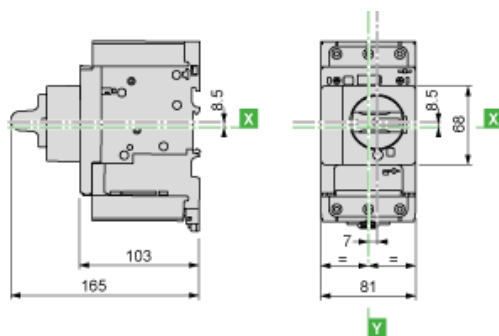

GV4L, GV4P, GV4LE, GV4PE, GV4PEM

Panel Mounting with M4 Screws

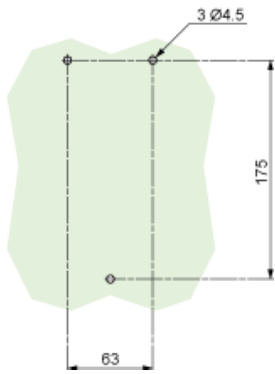

Door Cut-Out for Rotary Handle

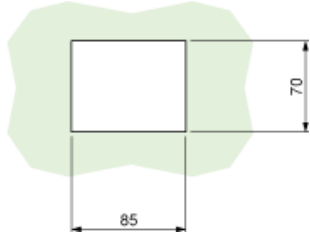

Minimum Safety Clearance

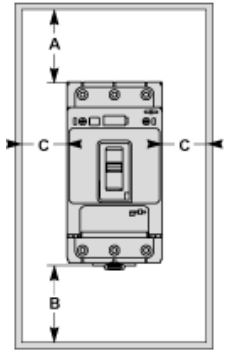

Toggle-type, rotary handle-type: identical clearance values.

| Safety Clearance (mm) | | | | | | |
|-----------------------|---------------------|---|---|------------------|---|---|
| | Painted Sheet Metal | | | Bare Sheet Metal | | |
| | A | B | C | A | B | C |
| No accessory | 30 | 0 | 0 | 40 | 0 | 5 |
| Interphase barriers | 0 | 0 | 0 | 0 | 0 | 5 |
| Long terminal shield | 0 | 0 | 0 | 0 | 0 | 5 |

Magnetic Motor Circuit Breakers

GV4L, GV4LE

