

GRM155R71C222KA01#

"#" indicates a package specification code.

Available  

< List of part numbers with package codes >
 GRM155R71C222KA01D , GRM155R71C222KA01J , GRM155R71C222KA01C , GRM155R71C222KA01B

Shape

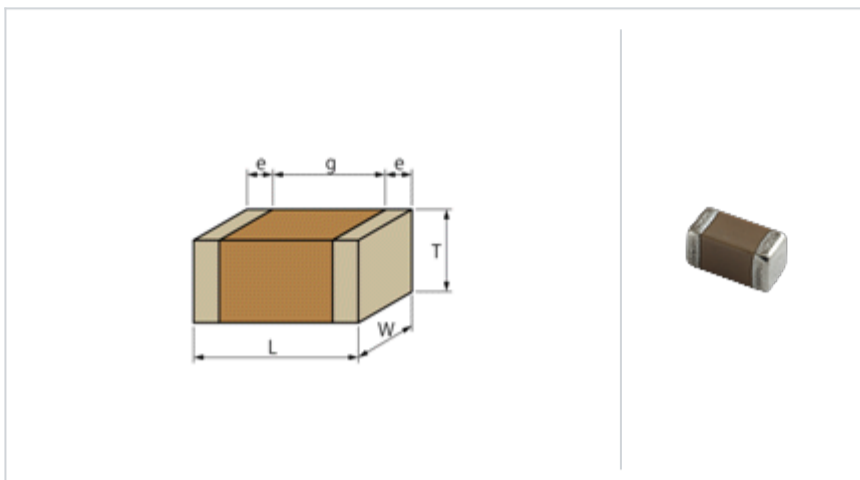

L size	1.0 ± 0.05mm
W size	0.5 ± 0.05mm
T size	0.5 ± 0.05mm
External terminal width e	0.15 to 0.35mm
Distance between external terminals g (Min.)	0.3mm
Size code in mm(inch)	1005 (0402)

References

Packaging	Specifications	Minimum quantity
D	Paper tape (180mm)	10000
J	Paper tape (330mm)	50000
C	Bulk case	50000
B	Packing in bulk	1000

Mass (typ.)	
1 piece	1.6mg
Reel (180mm)	118g

Specifications

Capacitance	2200pF ± 10%
Rated voltage	16Vdc
Temperature characteristics (complied standard)	X7R(EIA)
Capacitance change rate	± 15%
Temperature range of temperature characteristics	-55 to 125
Operating temperature range	-55 to 125

Attention

- 1.This datasheet is downloaded from the website of Murata Manufacturing Co., Ltd. Therefore, it ' s specifications are subject to change or our products in it may be discontinued without advance notice. Please check with our sales representatives or product engineers before ordering.
- 2.This datasheet has only typical specifications because there is no space for detailed specifications. Therefore, please review our product specifications or consult the approval sheet for product specifications before ordering.