



Product Description

GRF3042 is a broadband gain block designed for applications in the 0.01 to 15.0 GHz spectrum, exhibiting a typical low noise figure (NF) of 3.5 dB along with good gain flatness.

This device employs an external resistors to set a nominal I_{DDQ} of 45 mA. GRF3042 is internally matched to 50Ω at the input and output ports.

The device can be operated down to low frequency via the selection of suitably large input/output caps and bias inductor.

Consult with the GRF applications engineering team for custom tuning/evaluation board data and device s-parameters.

Features

- Reference: 4.0 GHz; I_{DDQ} : 45 mA
- Gain: 13.8 dB
- OP1dB: 13.0 dBm
- OIP3: 23.0 dBm
- NF: 3.5 dB
- Internally Matched to 50Ω
- Process: GaAs pHEMT

Applications

- Microwave Backhaul
- C and X-Band Amplifiers
- General Purpose Amplifiers
- Instrumentation

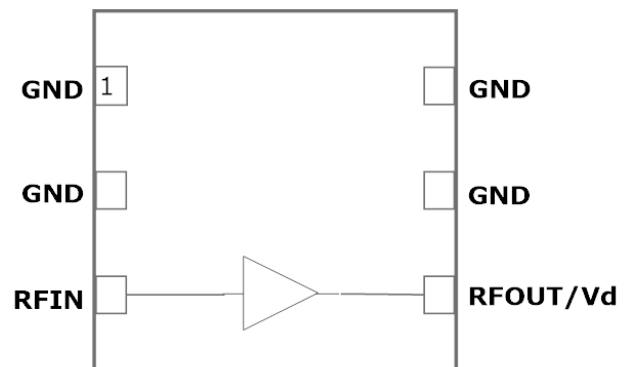

1.5 x 1.5 mm DFN-6

Absolute Ratings:

Parameter	Symbol	Min.	Max.	Unit
Drain Voltage	V _D	0	6.0	V
RF Input Power: (Load VSWR < 2:1; V _D : 5.0 volts)	P _{IN MAX}		17	dBm
Operating Temperature (Package Heat Sink)	T _{AMB}	-40	105	°C
Maximum Channel Temperature (MTTF > 10 ⁶ Hours)	T _{MAX}		170	°C
Maximum Dissipated Power	P _{DISS MAX}		350	mW
Electrostatic Discharge:				
Charged Device Model:	CDM	1500		V
Human Body Model:	HBM	250		V
Storage:				
Storage Temperature	T _{STG}	-65	150	°C
Moisture Sensitivity Level	MSL		1	--



Caution! ESD Sensitive Device



Exceeding Absolute Maximum Rating conditions may cause permanent damage to the device.

Note: For manufacturing information, see the Guerrilla-RF.com website for the following document located on the GRF3042 landing page: Manufacturing Note—MN-001 Product Tape and Reel, Solderability and Package Outline Specification.

[Link to manufacturing note](#)

Pin Out (Top View)

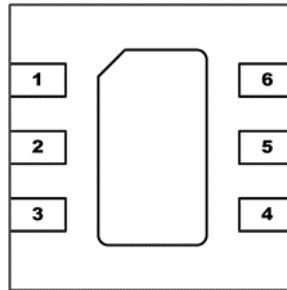

Pin Assignments:

Pin	Name	Description	Note
1	NC	No Connect or Ground	No internal connection to die
2	NC	No Connect or Ground	No internal connection to die
3	RF_In	LNA RF input	Internally matched 50Ω. An external DC blocking cap must be used.
4	RF_Out/V _{DD}	LNA RF output	Internally matched 50Ω. V _{DD} must be applied through a choke to this pin
5	NC	No Connect or Ground	No internal connection to die
6	NC	No Connect or Ground	No internal connection to die
PKG BASE	GND	Ground	Provides DC and RF ground for LNA, as well as thermal heat sink. Recommend multiple 8 mil vias beneath the package for optimal RF and thermal performance. Refer to evaluation board top layer graphic on schematic page.



Preliminary

GRF3042

Broadband Gain Block
10 MHz to 15.0 GHz

Nominal Operating Parameters:

Parameter	Symbol	Specification			Unit	Condition
		Min.	Typ.	Max.		
Gain Mode (Venable high)						$I_{DDQ} = 45 \text{ mA}$, $T_A = 25^\circ \text{C}$
Test Frequency	F_{TEST}		4.0		GHz	
Gain	S21		13.8		dB	
Noise Figure	NF		3.5		dB	Input trace losses de-embedded
Output 3rd Order Intercept	OIP3		23.0		dBm	0 dBm P_{OUT} per tone at 2 MHz Spacing (3999 and 4001 MHz)
Output 1dB Compression Power	OP1dB		13.0		dBm	
Switching Rise Time	T_{RISE}		TBD		ns	
Switching Fall Time	T_{FALL}		TBD		ns	
Supply Current	I_{DDQ}		45		mA	Ref: $V_{DD} = 5.0 \text{ V}$; $R_{BIAS} = 12 \text{ Ohm}$
Thermal Data						
Thermal Resistance (measured via IR scan)	Θ_{jc}		218		$^\circ\text{C}/\text{W}$	On standard evaluation board
Channel Temperature @ +85 C Reference (Package Heat Sink)	$T_{CHANNEL}$		129 (See note)		$^\circ\text{C}$	$V_D = 4.5 \text{ V}$; $I_{DDQ} = 45 \text{ mA}$; No RF; $P_{DISS} = 203 \text{ mW}$

Note: $MTTF > 10^6$ hours for $T_{CHANNEL} < = 170$ degrees C.



Preliminary

GRF3042

Broadband Gain Block
10 MHz to 15.0 GHz

GRF3042 Evaluation Board Measured Data:

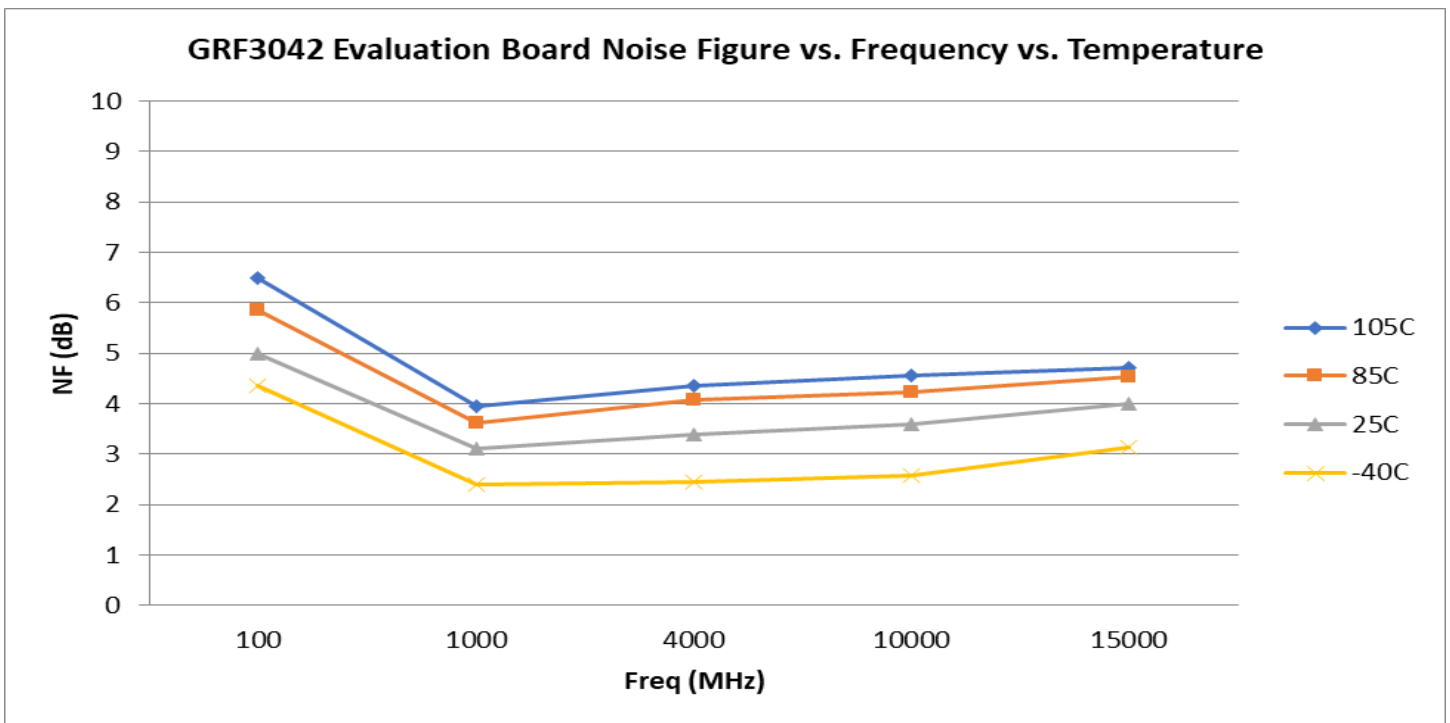
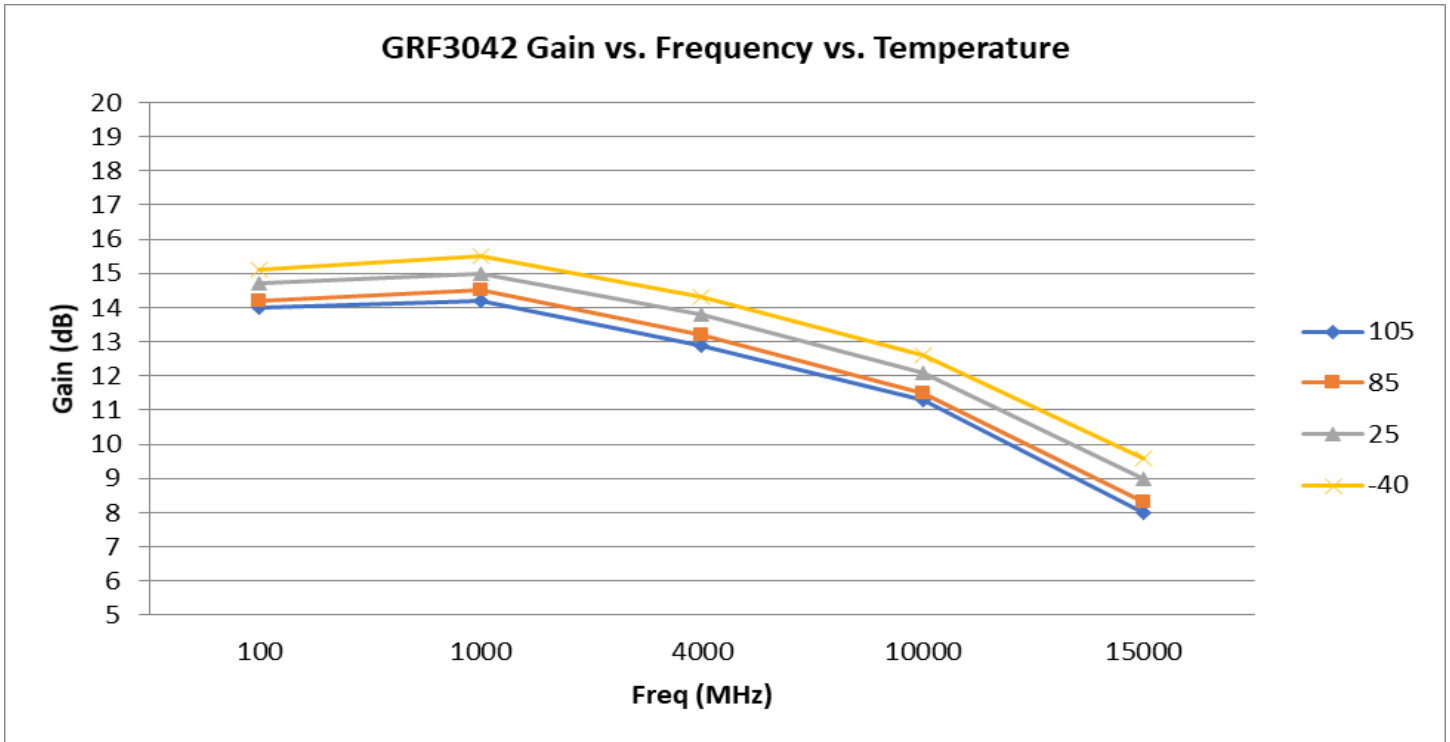



Preliminary

GRF3042

Broadband Gain Block
10 MHz to 15.0 GHz

GRF3042 Evaluation Board Measured Data:

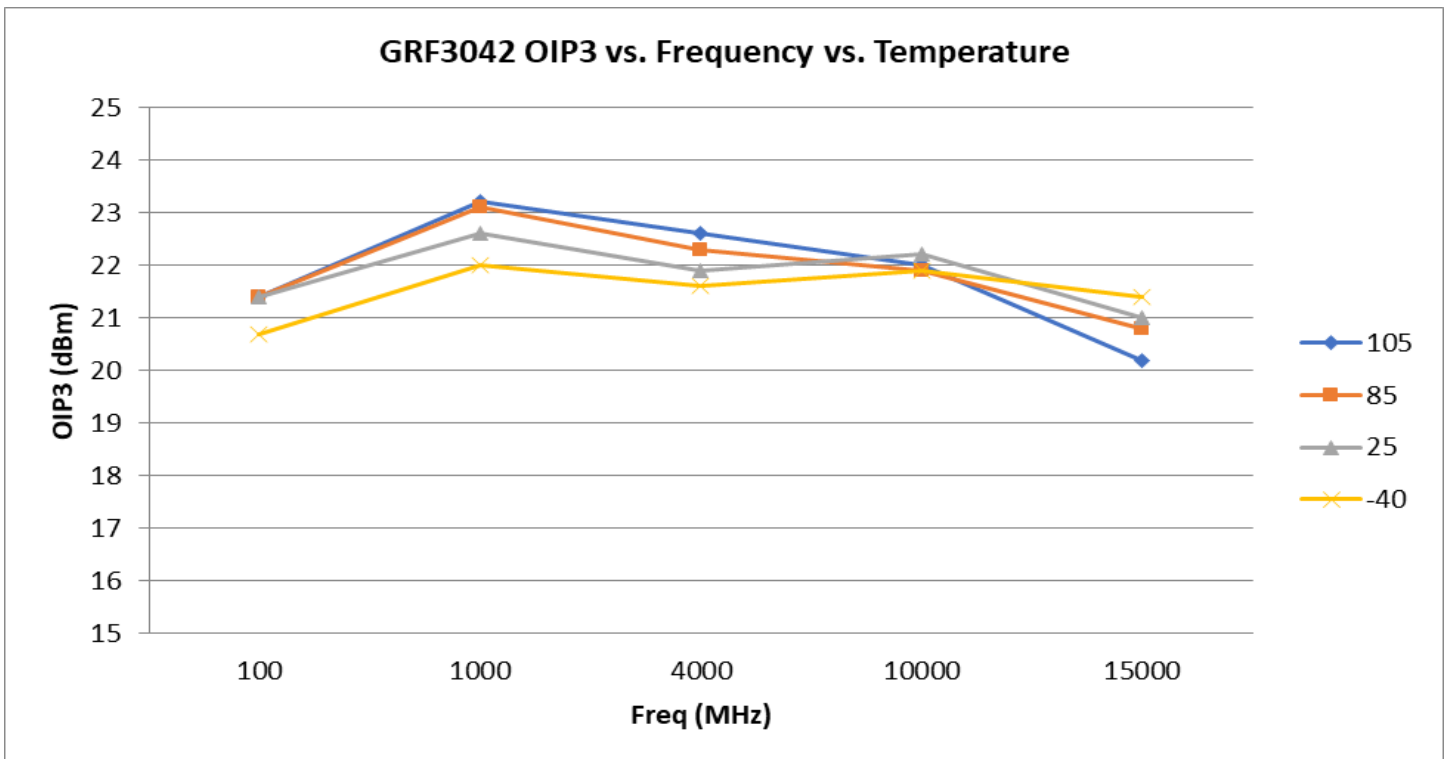
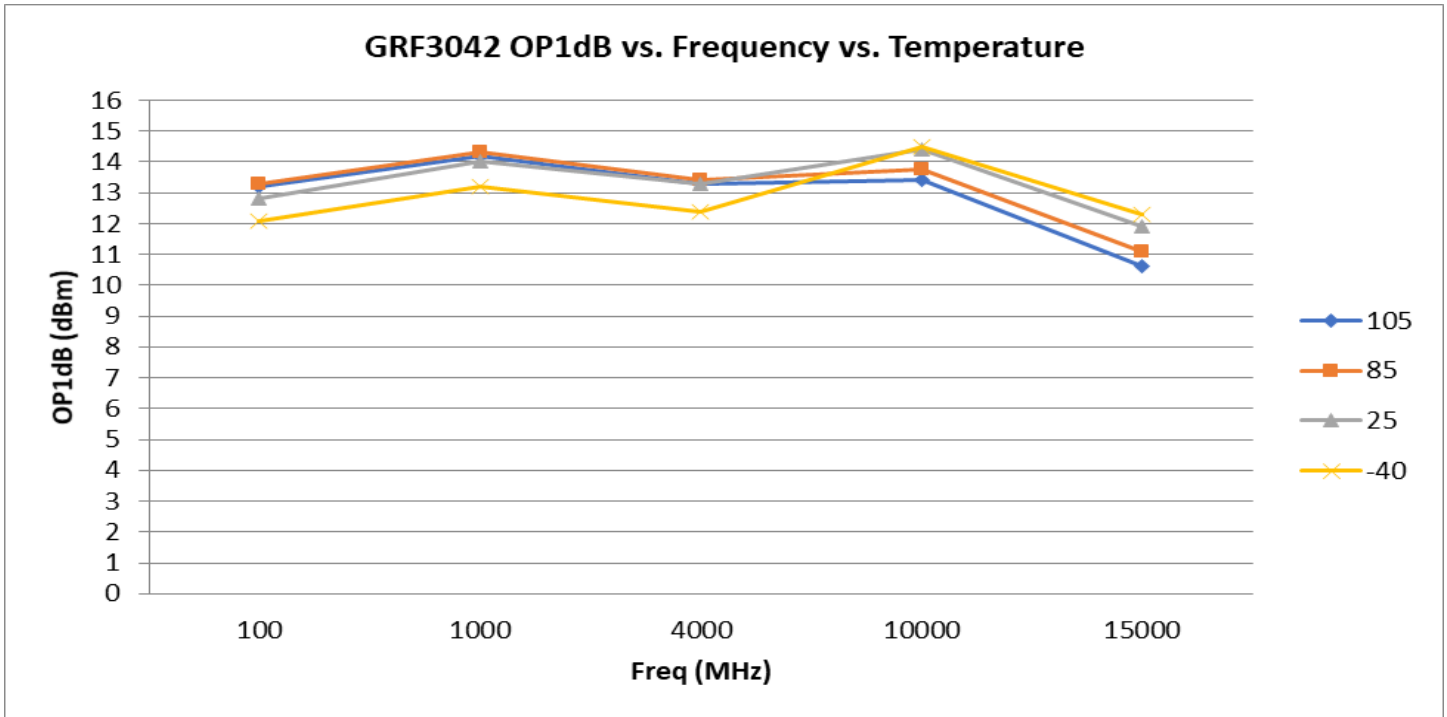

GRF3042 Evaluation Board S-Pars and Stability Mu Factor:

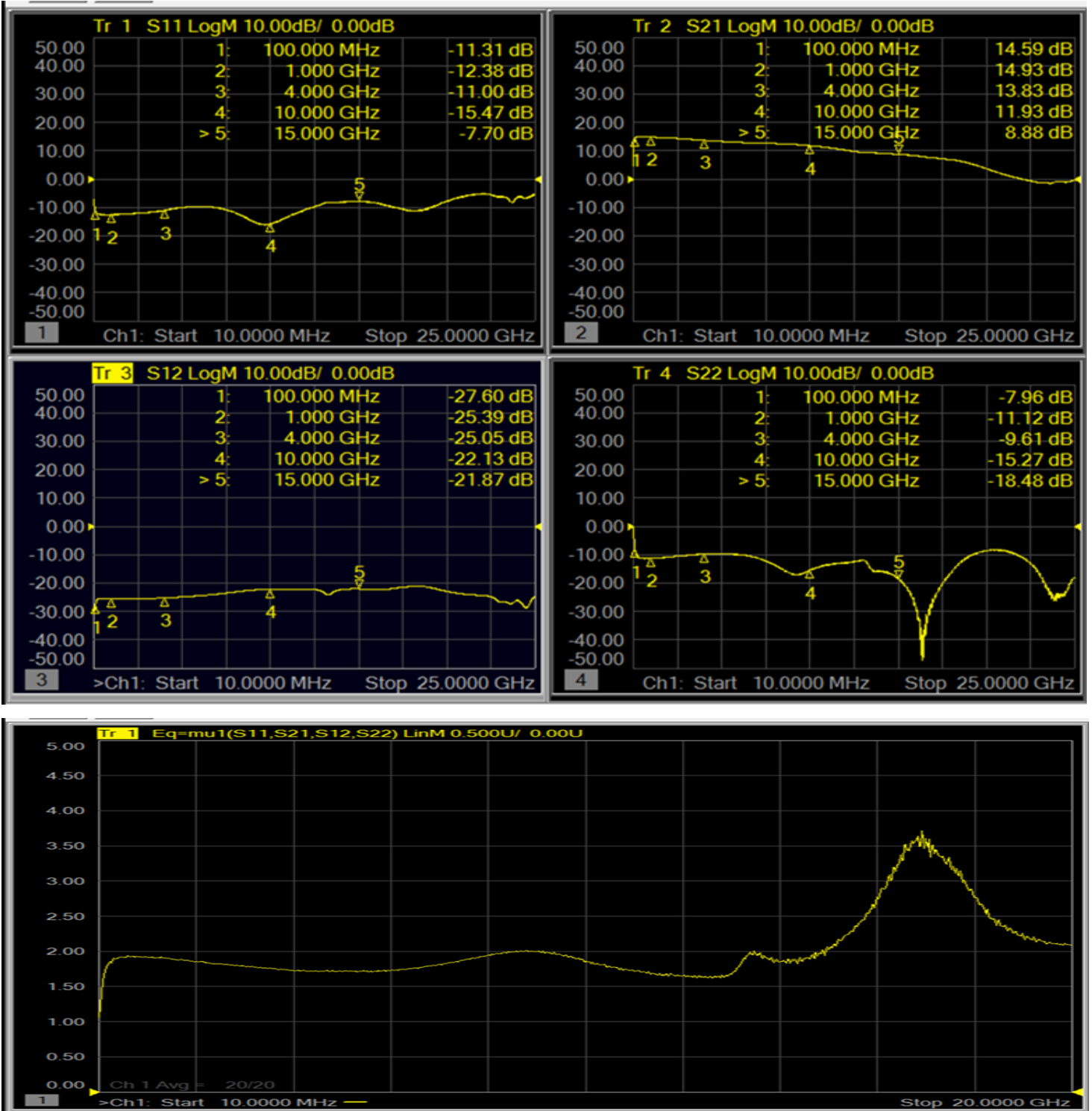

Note: Mu factor ≥ 1.0 implies unconditional stability.

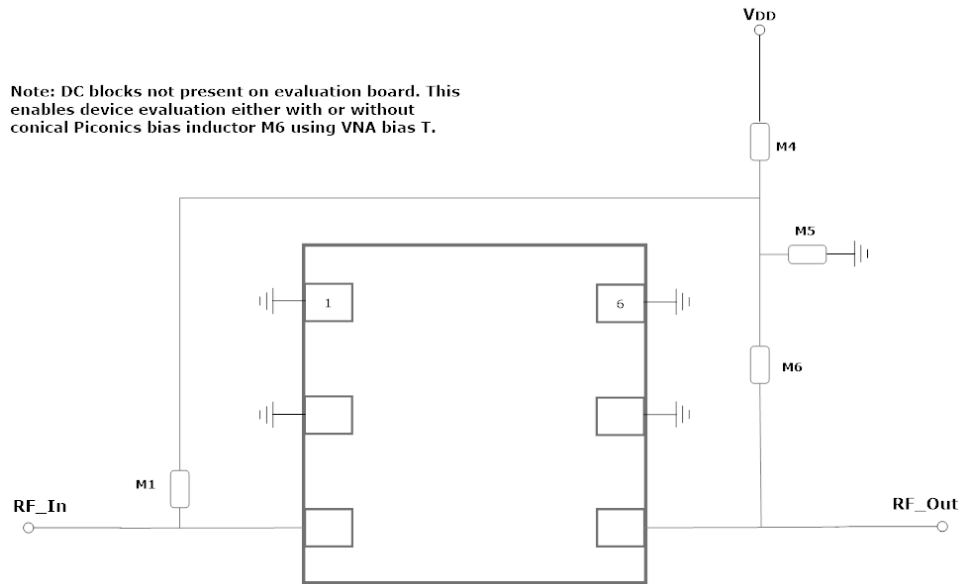

GRF3042 Standard Application Schematic

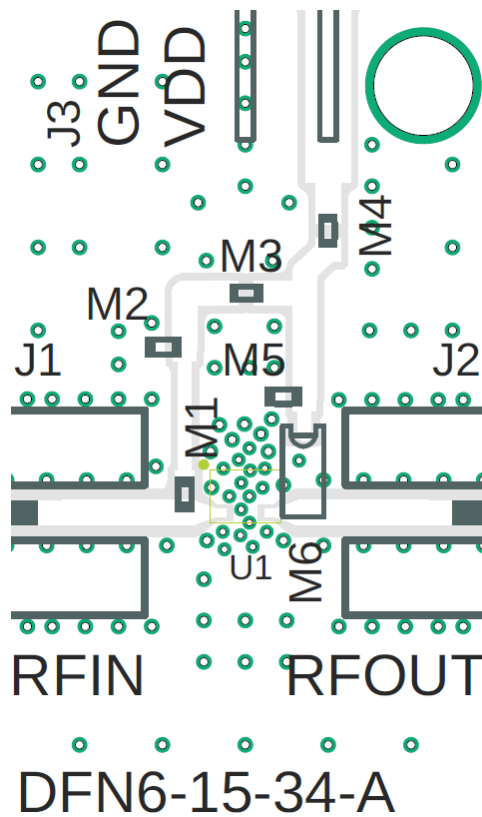

GRF3042 Evaluation Board Assembly Drawing (TBD)



Preliminary

GRF3042

**Broadband Gain Block
10 MHz to 15.0 GHz**

GRF3042 Standard Evaluation Board BOM: (TBD)

Component	Type	Manufacturer	Family	Value	Package Size	Substitution
M1	Resistor	Various	5%	1.67k Ohm	0201	Yes
M3 (jumper)	Resistor	Various	5%	0 Ohm	0201	Yes
M4	Resistor	Various	5%	12 Ohm	0201	Yes
M5	Capacitor	Murata	GRM	0.1 uF	0201	Yes
M6	Inductor	Piconics	CC19T40K240G5-C	—	—	Yes
Evaluation Board	DFN6-15-34-A					

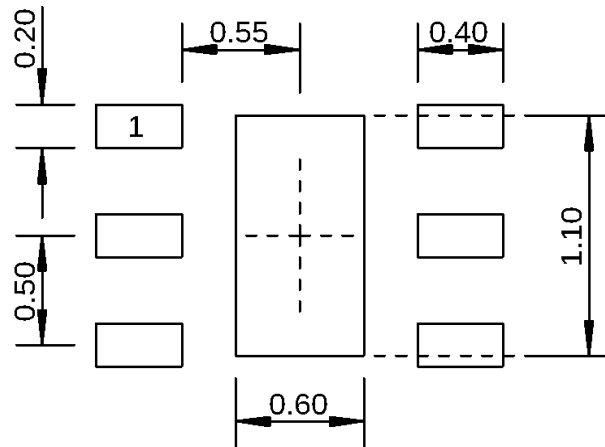

Dimensions in millimeters

1.5 mm DFN-6 Suggested PCB Footprint (Top View)

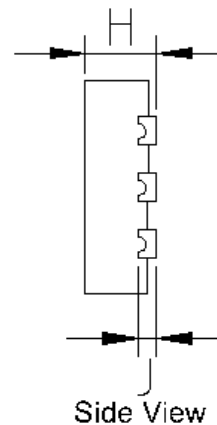
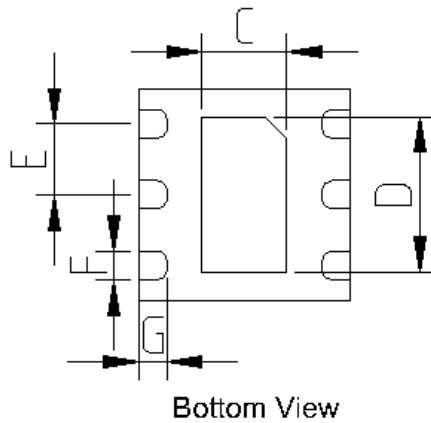
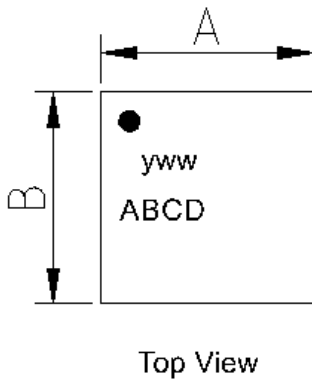

Dimensions (MM)	
A	1.5 +/- 0.050
B	1.5 +/- 0.050
C	.6 +/- 0.050
D	1.1 +/- 0.050
E	.5 Bsc
F	.2 +/- 0.050
G	.2 +/- 0.050
H	.45 +/- 0.050
J	.12 Ref.

1.5 mm DFN-6 Package Dimensions

Tape and Reel Information:

Guerrilla RF's Tape and Reel specification complies with the Electronics Industries Association (EIA) standards for 'Embossed Carrier Tape of Surface Mount Components for Automatic Handling'. Reference EIA-481. See the table on the following page for Tape and Reel specifications along with units per reel.

Devices are loaded with pins down into the carrier pocket with protective cover tape, wound into a plastic reel. Each reel will be packaged in a cardboard box. There will be product labels on the reel, the protective ESD bag and the outside surface of the box.

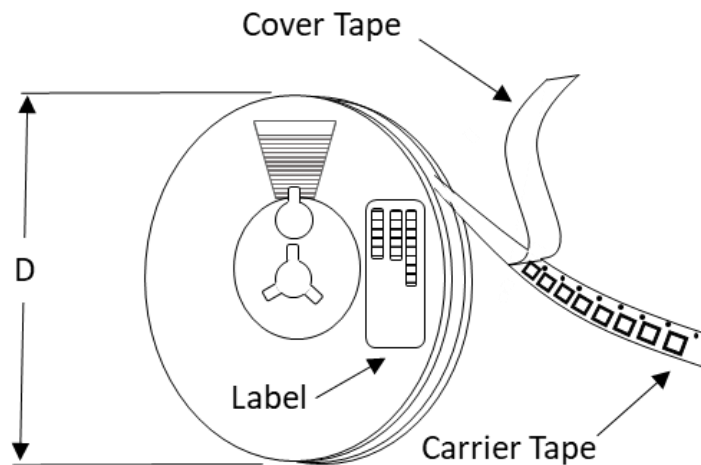

Tape and Reel Packaging with Reel Diameter Noted (D)

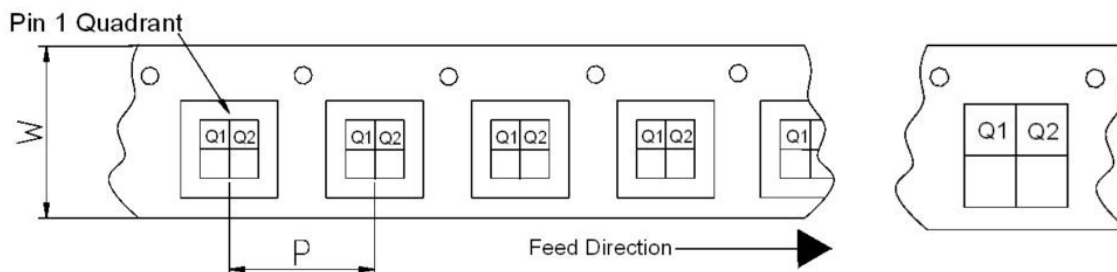

Carrier Tape Width (W), Pitch (P), Feed Direction and Pin 1 Quadrant Information



Preliminary

GRF3042

Broadband Gain Block
10 MHz to 15.0 GHz

Tape and Reel Specification and Device Package Information Table

Package				Carrier Tape			Reel	
Type	Dimensions (mm)	Leads	Weight (mg)	Width (W) (mm)	Pocket Pitch (P) (mm)	Pin 1 Quadrant	Diameter (D) (inches)	Units per Reel
QFN	2.0 x 2.0 x 0.50	12	7	8	4	Q1	7	2500
QFN	3.0 x 3.0 x 0.85	16	24	12	8	Q1	7	1500
DFN	1.5 x 1.5 x 0.45	6	4	8	4	Q1	7	2500
DFN	2.0 x 2.0 x 0.75	8	12	8	4	Q1	7	2500
LFM	3.5 x 3.5 x 0.75	See	TBD	12	8	Q2	7	1500
LFM	4.0 x 4.0 x 0.75	See note	TBD	12	8	Q2	7	1500

Note: Lead count may vary. Reference applicable product data sheet



Preliminary

GRF3042

Broadband Gain Block 10 MHz to 15.0 GHz

Data Sheet Release Status:	Notes
Advance	S-parameter and NF data based on EM simulations for the fully packaged device using foundry supplied transistor s-parameters. Linearity estimates based on device size, bias condition and experience with related devices.
Preliminary	All data based on evaluation board measurements in the Guerrilla RF Applications Lab.
Released	All data based on device qualification data. Typically, this data is nearly identical to the data found in the preliminary version. Max and min values for key RF parameters are included.

Information in this datasheet is specific to the Guerrilla RF, Inc. ("Guerrilla RF") product identified.

This datasheet, including the information contained in it, is provided by Guerrilla RF as a service to its customers and may be used for informational purposes only by the customer. Guerrilla RF assumes no responsibility for errors or omissions on this datasheet or the information contained herein. Information provided is believed to be accurate and reliable, however, no responsibility is assumed by Guerrilla RF for its use, nor for any infringement of patents, or other rights of third parties, resulting from its use. Guerrilla RF assumes no liability for any datasheet, datasheet information, materials, products, product information, or other information provided hereunder, including the sale, distribution, reproduction or use of Guerrilla RF products, information or materials.

No license, whether express, implied, by estoppel, by implication or otherwise is granted by this datasheet for any intellectual property of Guerrilla RF, or any third party, including without limitation, patents, patent rights, copyrights, trademarks and trade secrets. All rights are reserved by Guerrilla RF.

All information herein, products, product information, datasheets, and datasheet information are subject to change and availability without notice. Guerrilla RF reserves the right to change component circuitry, recommended application circuitry and specifications at any time without prior notice. Guerrilla RF may further change its datasheet, product information, documentation, products, services, specifications or product descriptions at any time, without notice. Guerrilla RF makes no commitment to update any materials or information and shall have no responsibility whatsoever for conflicts, incompatibilities, or other difficulties arising from any future changes.

GUERRILLA RF INFORMATION, PRODUCTS, PRODUCT INFORMATION, DATASHEETS AND DATASHEET INFORMATION ARE PROVIDED "AS IS" AND WITHOUT WARRANTY OF ANY KIND, WHETHER EXPRESS, IMPLIED, STATUTORY, OR OTHERWISE, INCLUDING FITNESS FOR A PARTICULAR PURPOSE OR USE, MERCHANTABILITY, PERFORMANCE, QUALITY OR NON-INFRINGEMENT OF ANY INTELLECTUAL PROPERTY RIGHT; ALL SUCH WARRANTIES ARE HEREBY EXPRESSLY DISCLAIMED. GUERRILLA RF DOES NOT WARRANT THE ACCURACY OR COMPLETENESS OF THE INFORMATION, TEXT, GRAPHICS OR OTHER ITEMS CONTAINED WITHIN THESE MATERIALS. GUERRILLA RF SHALL NOT BE LIABLE FOR ANY DAMAGES, INCLUDING BUT NOT LIMITED TO ANY SPECIAL, INDIRECT, INCIDENTAL, STATUTORY, OR CONSEQUENTIAL DAMAGES, INCLUDING WITHOUT LIMITATION, LOST REVENUES OR LOST PROFITS THAT MAY RESULT FROM THE USE OF THE MATERIALS OR INFORMATION, WHETHER OR NOT THE RECIPIENT OF MATERIALS HAS BEEN ADVISED OF THE POSSIBILITY OF SUCH DAMAGE.

Customers are solely responsible for their use of Guerrilla RF products in the Customer's products and applications or in ways which deviate from Guerrilla RF's published specifications, either intentionally or as a result of design defects, errors, or operation of products outside of published parameters or design specifications. Customers should include design and operating safeguards to minimize these and other risks. Guerrilla RF assumes no liability or responsibility for applications assistance, customer product design, or damage to any equipment resulting from the use of Guerrilla RF products outside of stated published specifications or parameters.



Preliminary

GRF3042

**Broadband Gain Block
10 MHz to 15.0 GHz**

Mouser Electronics

Authorized Distributor

Click to View Pricing, Inventory, Delivery & Lifecycle Information:

[Guerrilla RF:](#)

[GRF3042-EVB](#) [GRF3042](#)