

## LISA3-RS-PIN

~15° spot beam with location pin installation

### TECHNICAL SPECIFICATIONS:

Dimensions	Ø 10.0 mm
Height	7.9 mm
Fastening	glue
Colour	black
Box size	310 x 230 x 60 mm
Box weight	1.3 kg
Quantity in Box	2000 pcs
ROHS compliant	yes ⓘ



### MATERIAL SPECIFICATIONS:

Component	Type	Material	Colour
LISA3-RS	Single lens	PMMA	clear
LISA3-HLD-PIN	Holder	PC	black

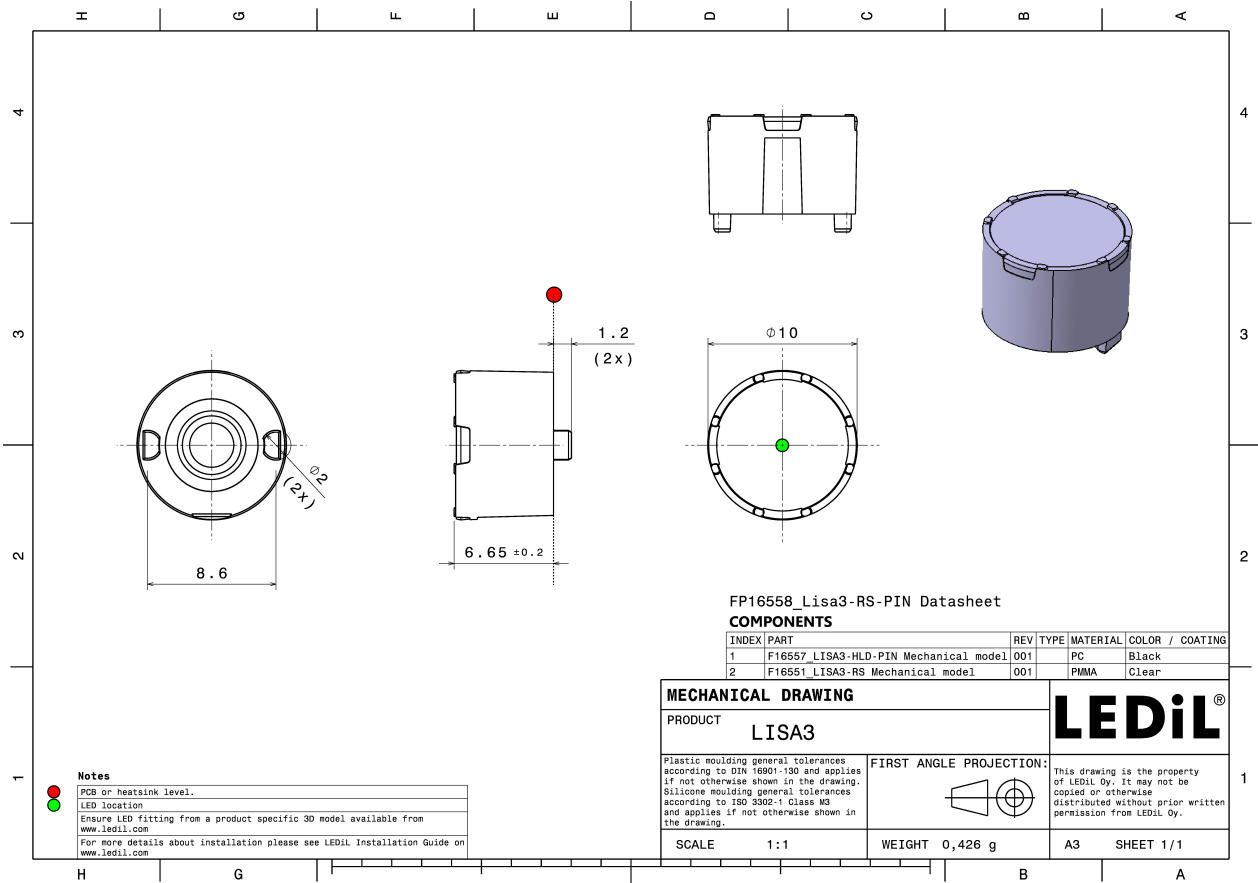

#### PHOTOMETRIC DATA (MEASURED):



LED NF2x757G  
FWHM 25.0°  
Efficiency 88 %  
Peak intensity 3.300 cd/lm  
LEDs/each optic 1  
Light colour White  
Required components:

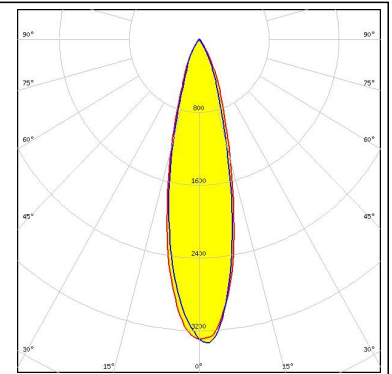
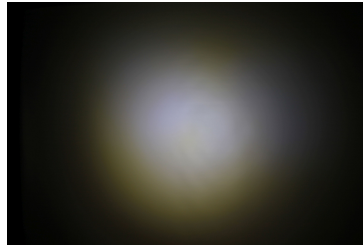

#### PHOTOMETRIC DATA (SIMULATED):



LED XP-E  
 FWHM 15.0°  
 Efficiency 90 %  
 Peak intensity 8.500 cd/lm  
 LEDs/each optic 1  
 Light colour White  
 Required components:

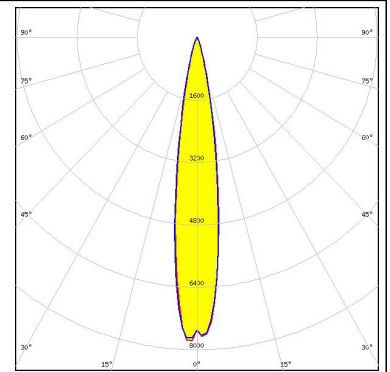

LED XP-E2  
 FWHM 14.3°  
 Efficiency 89 %  
 Peak intensity 9.400 cd/lm  
 LEDs/each optic 1  
 Light colour White  
 Required components:

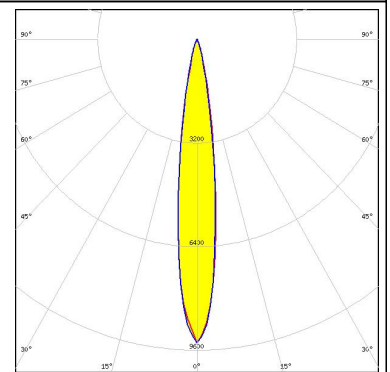

LED LUXEON V2  
 FWHM 22.0°  
 Efficiency 90 %  
 Peak intensity 3.780 cd/lm  
 LEDs/each optic 1  
 Light colour White  
 Required components:

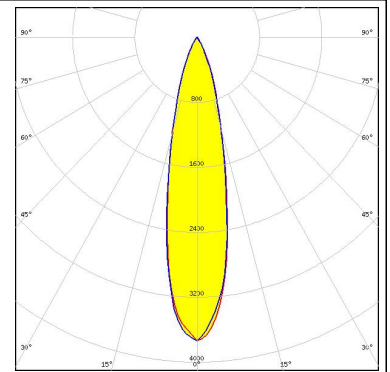

LED LUXEON Z  
 FWHM 12.0°  
 Efficiency 87 %  
 Peak intensity 13.200 cd/lm  
 LEDs/each optic 1  
 Light colour White  
 Required components:

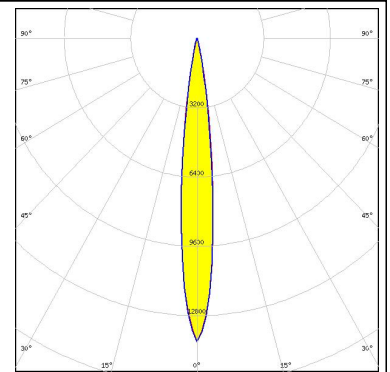

#### PHOTOMETRIC DATA (SIMULATED):

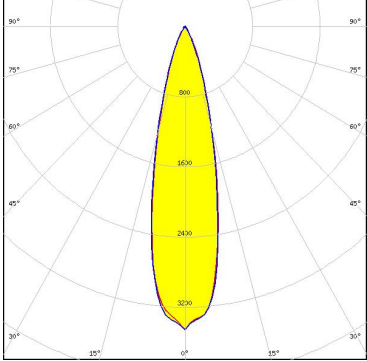
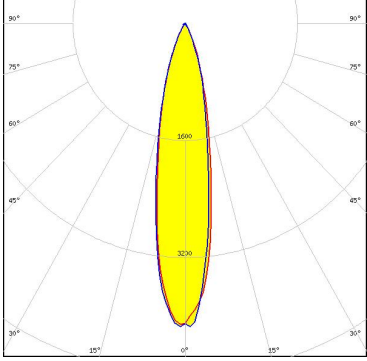
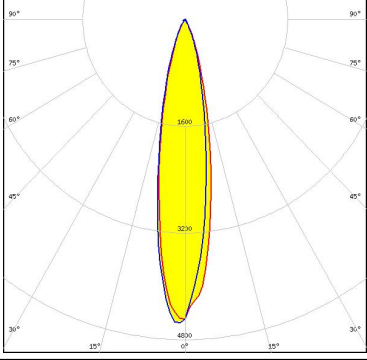
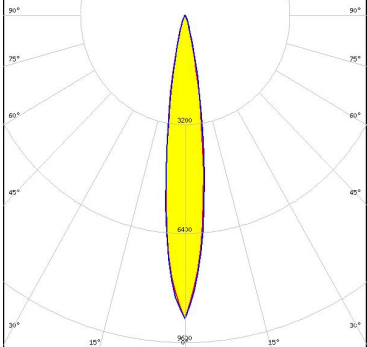
<p><b>NICHIA</b></p> <p>LED NVSxx19B/NVSxx19C            FWHM 25.0°            Efficiency 85 %            Peak intensity 3.470 cd/lm            LEDs/each optic 1            Light colour White            Required components:</p>	
<p><b>OSRAM</b> Opto Semiconductors</p> <p>LED Duris S5 (2 chip)            FWHM 20.0°            Efficiency 87 %            Peak intensity 7.050 cd/lm            LEDs/each optic 1            Light colour White            Required components:</p>	
<p><b>OSRAM</b> Opto Semiconductors</p> <p>LED Duris S5 (Single chip)            FWHM 20.0°            Efficiency 86 %            Peak intensity 4.500 cd/lm            LEDs/each optic 1            Light colour White            Required components:</p>	
<p><b>OSRAM</b> Opto Semiconductors</p> <p>LED OSLOM SSL 150            FWHM 14.5°            Efficiency 88 %            Peak intensity 8.740 cd/lm            LEDs/each optic 1            Light colour White            Required components:</p>	

#### PHOTOMETRIC DATA (SIMULATED):

#### OSRAM

Opto Semiconductors

LED OSLON SSL 80  
FWHM 15.0°  
Efficiency 87 %  
Peak intensity 7.550 cd/lm  
LEDs/each optic 1  
Light colour White  
Required components:

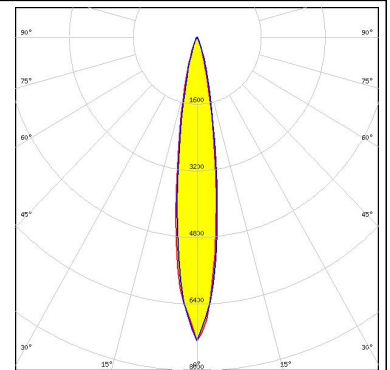

#### SAMSUNG

LED LM301A  
FWHM 14.5°  
Efficiency 87 %  
Peak intensity 7.050 cd/lm  
LEDs/each optic 1  
Light colour White  
Required components:

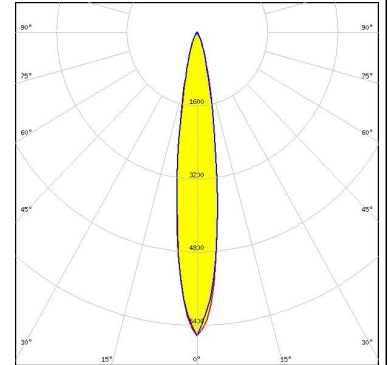

#### SAMSUNG

LED LM302A  
FWHM 16.0°  
Efficiency 87 %  
Peak intensity 5.300 cd/lm  
LEDs/each optic 1  
Light colour White  
Required components:

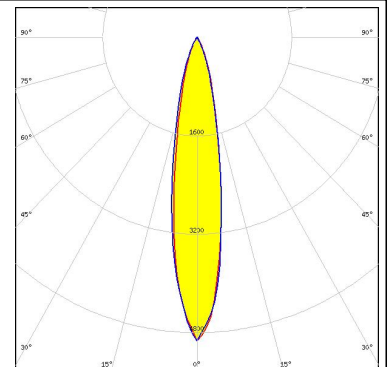

### GENERAL INFORMATION:

NOTE: The typical beam angle will be changed by different color, chip size and chip position tolerance. The typical total beam angle is the full angle measured where the luminous intensity is half of the peak value.

### MATERIALS:

As part of our continuous research and improvement processes, and to ensure the best possible quality and availability of our products, LEDiL reserves the right to change material grades without notice.

### PRODUCT DATA USER AGREEMENT AND DISCLAIMER:

The measured data in the provided downloadable LEDiL Product Datasheets and Mechanical 2D-Drawings is rounded and provided as reference for planning. LEDiL Oy's optical specifications have been verified by conducting performance testing of the products in accordance with the company's quality system. The reported data are averaged results of multiple measurements with typical variation. LEDiL Oy reserves the right to without prior notification make changes and improvements to its products.

LEDiL Oy assumes neither warranty, nor guarantee nor any other liability of any kind for the contents and correctness of the provided data. The provided data has been generated with highest diligence but the provided data may in reality not represent the complete possible variation range of all intrinsic parameters. Therefore, in certain cases a deviation from the provided data could occur.

LEDiL Oy reserves the right to undertake technical changes of its products without further notification which could lead to changes in the provided data. LEDiL Oy assumes no liability of any kind for the possible deviation from any provided data or any other damage resulting from the usage of the provided data.

The user agrees to this disclaimer and user agreement with the download or usage of the provided files.

#### LEDiL Oy

Joensuunkatu 13  
FI-24240 SALO  
Finland

#### LEDiL Inc.

228 West Page Street  
Suite D  
Sycamore IL 60178  
USA

#### Local sales and technical support

[www.ledil.com/  
where\\_to\\_buy](http://www.ledil.com/where_to_buy)

#### Shipping locations

Salo, Finland  
Hong Kong, China

#### Distribution Partners

[www.ledil.com/  
where\\_to\\_buy](http://www.ledil.com/where_to_buy)