

RONDA-WWW-C

~90° wide beam with holder C compatible with LEDiL HEKLA

TECHNICAL SPECIFICATIONS:

Dimensions	Ø 53.9 mm
Height	16.6 mm
Fastening	socket
Colour	clear
Box size	
Box weight	0 kg
Quantity in Box	420 pcs
ROHS compliant	yes ⓘ





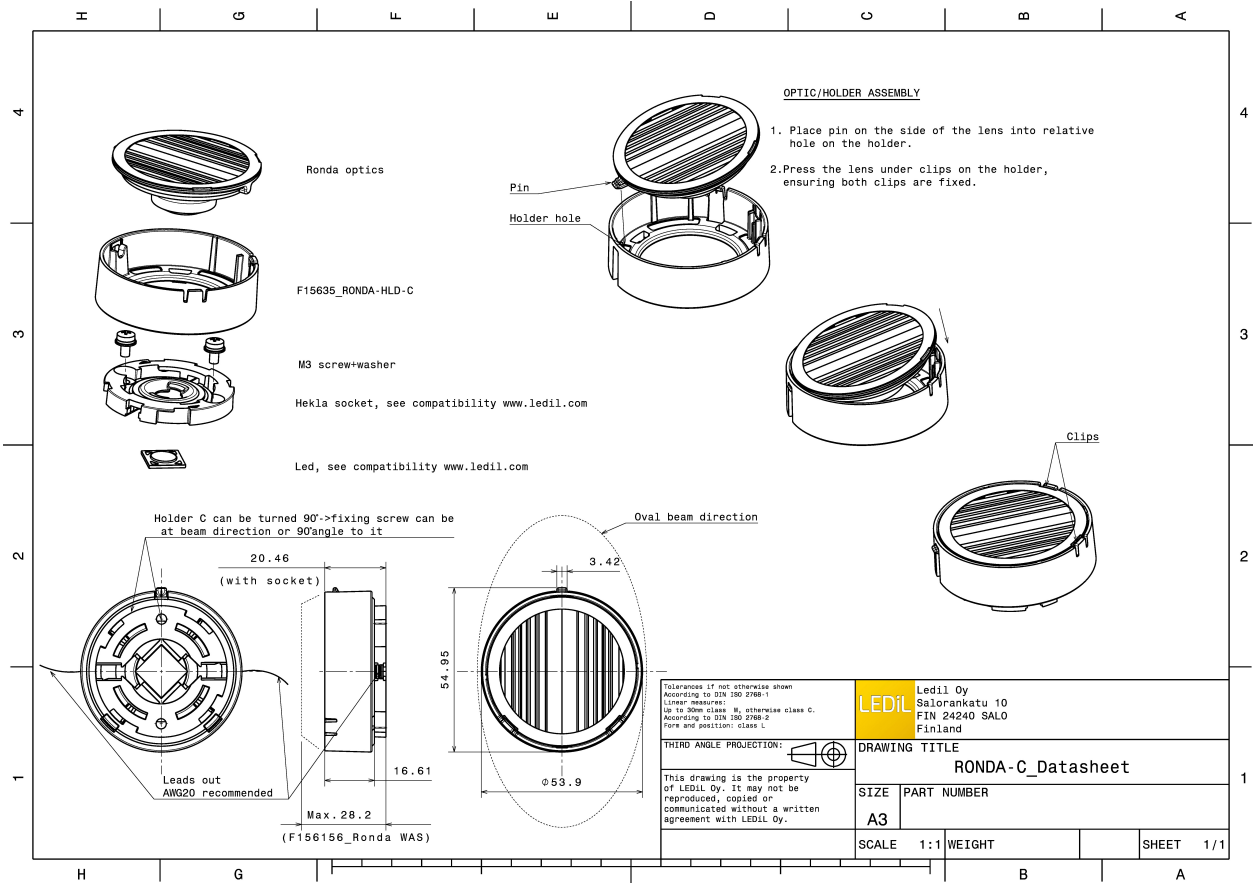

MATERIAL SPECIFICATIONS:

Component	Type	Material	Colour
RONDA-WWW	Lens	PMMA	clear
RONDA-HLD-C	Holder	PC	clear

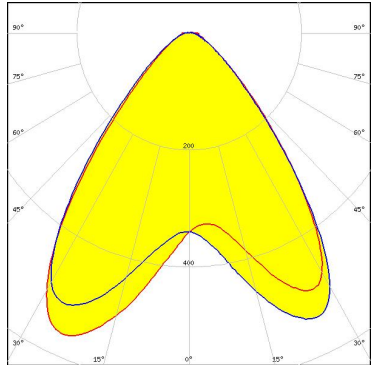
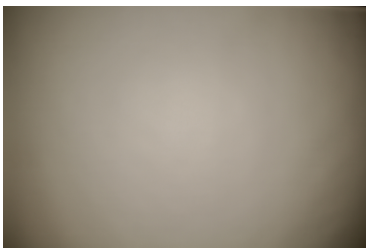
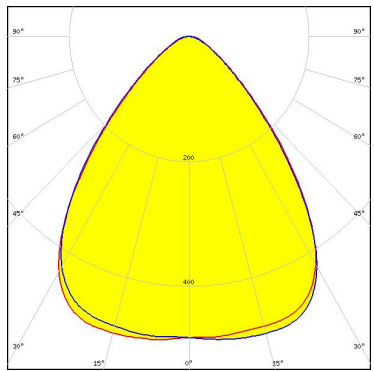

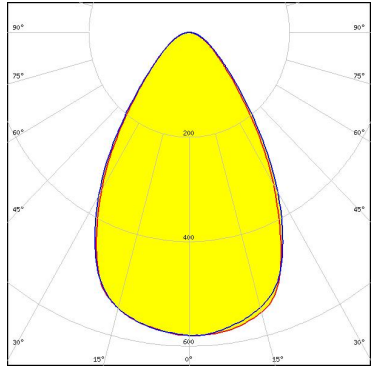
PHOTOMETRIC DATA (MEASURED):

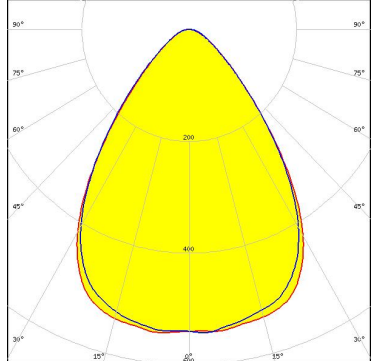
<p>bridgelux.</p> <p>LED V6 Gen6 FWHM 89.0° Efficiency 90 % Peak intensity 0.560 cd/lm Required components: LEDiL: F15253_HEKLA-SOCKET-A</p>		
<p>bridgelux.</p> <p>LED VERO10 FWHM 82.0° Efficiency 89 % Peak intensity 0.490 cd/lm Required components: F15616_HEKLA-SOCKET-F</p>		
<p>bridgelux.</p> <p>LED Vesta DTW 15mm (33W) FWHM 67.0° Efficiency 78 % Peak intensity 0.580 cd/lm Required components: C16142_HEKLA-SOCKET-K Bender Wirth: 491 Typ L8</p>		
<p>bridgelux.</p> <p>LED Vesta TW 9mm (12W) FWHM 75.0° Efficiency 86 % Peak intensity 0.550 cd/lm Required components: LEDiL: C16142_HEKLA-SOCKET-K</p>		

PHOTOMETRIC DATA (MEASURED):

CITIZEN

LED CLC020 Series (Dim-To-Warm)
FWHM 73.0°
Efficiency 86 %
Peak intensity 0.590 cd/lm
Required components:
LEDiL: C16142_HEKLA-SOCKET-K

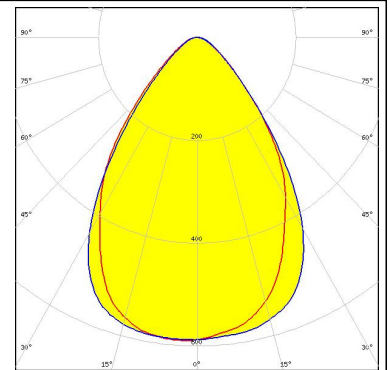
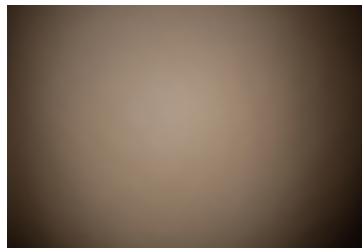

CITIZEN

LED CLL02x/CLU02x (LES10)
FWHM 81.0°
Efficiency 89 %
Peak intensity 0.500 cd/lm
Required components:
LEDiL: F15255_HEKLA-SOCKET-C

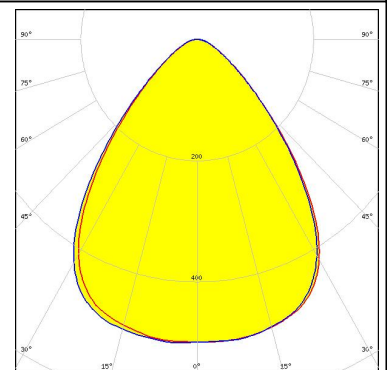
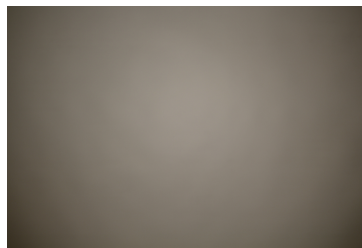

CITIZEN

LED CLU700/701
FWHM 93.0°
Efficiency 89 %
Peak intensity 0.520 cd/lm
Required components:
LEDiL: F15255_HEKLA-SOCKET-C

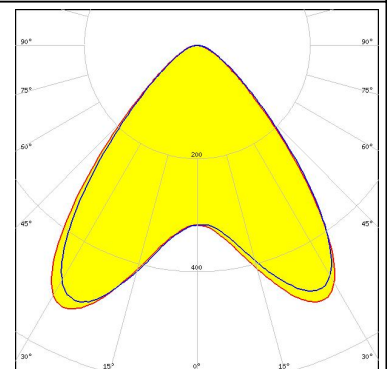
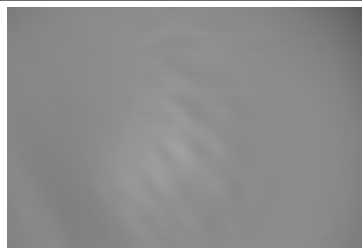

CITIZEN

LED LCN-C01B (Tunable White)
FWHM 74.0°
Efficiency 86 %
Peak intensity 0.570 cd/lm
Required components:
LEDiL: C16142_HEKLA-SOCKET-K

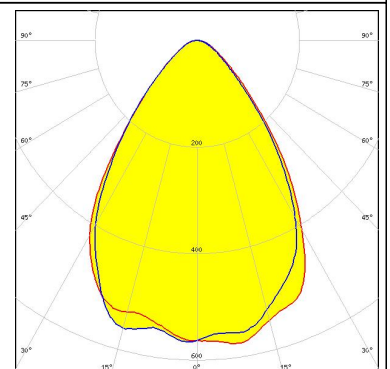
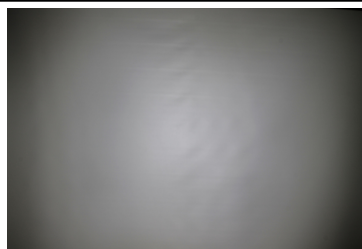

PHOTOMETRIC DATA (MEASURED):



LED CXA/B 13xx
 FWHM 94.0°
 Efficiency 90 %
 Peak intensity 0.500 cd/lm
 Required components:
 F15254_HEKLA-SOCKET-B
 LEDiL: F15956_HEKLA-SOCKET-J

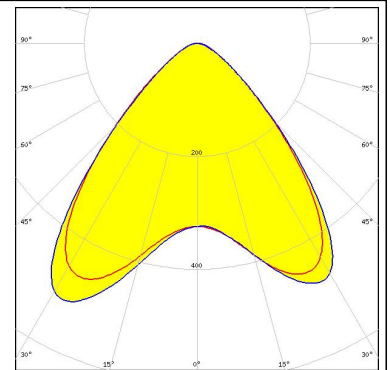

LED CXA/B 15xx
 FWHM 84.0°
 Efficiency 90 %
 Peak intensity 0.500 cd/lm
 Required components:
 LEDiL: F15256_HEKLA-SOCKET-D

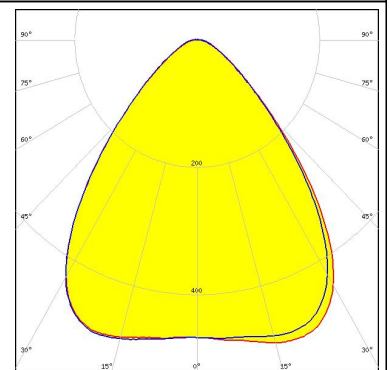

LED LUXEON CoB 1202s
 FWHM 94.0°
 Efficiency 90 %
 Peak intensity 0.500 cd/lm
 Required components:
 LEDiL: F15848_HEKLA-SOCKET-G

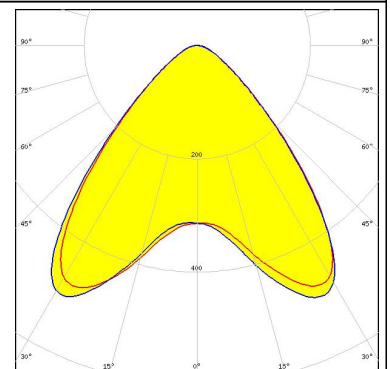
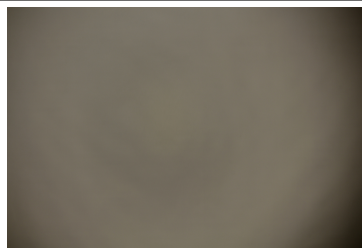

LED CXM-9
 FWHM 80.0°
 Efficiency 89 %
 Peak intensity 0.520 cd/lm
 Required components:
 LEDiL: F15255_HEKLA-SOCKET-C

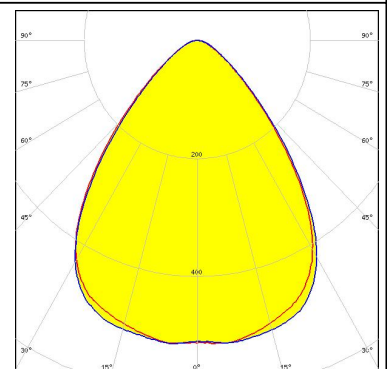
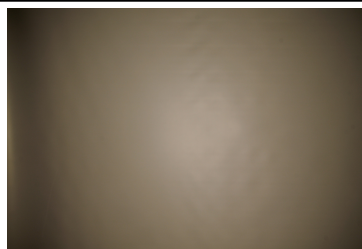

PHOTOMETRIC DATA (MEASURED):

SAMSUNG

LED COB D Series LES 14.5 mm
 FWHM 80.0°
 Efficiency 82 %
 Peak intensity 0.470 cd/lm
 Required components:
 LEDiL: F15859_HEKLA-SOCKET-I

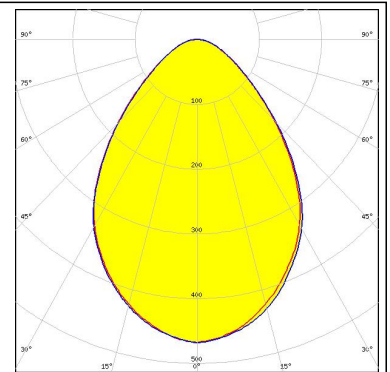
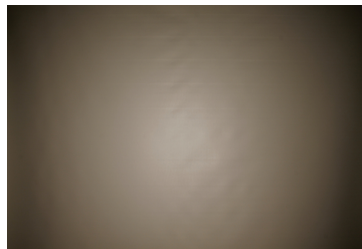

SAMSUNG

LED COB D Series LES 9.8 mm
 FWHM 81.0°
 Efficiency 90 %
 Peak intensity 0.510 cd/lm
 Required components:
 LEDiL: F15255_HEKLA-SOCKET-C

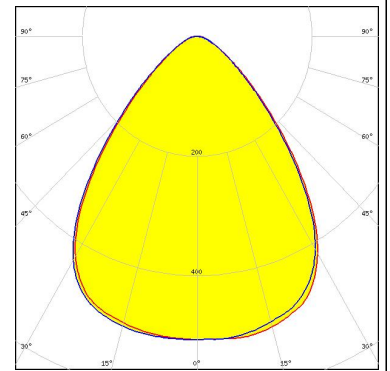
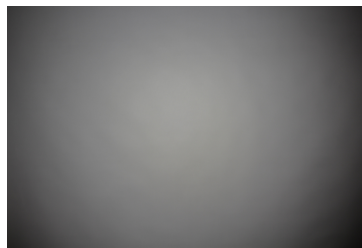

SAMSUNG

LED LC010C
 FWHM 94.0°
 Efficiency 89 %
 Peak intensity 0.480 cd/lm
 Required components:
 LEDiL: F15848_HEKLA-SOCKET-G

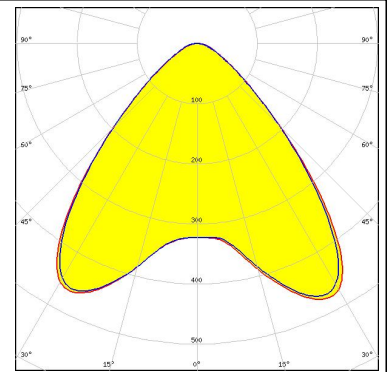

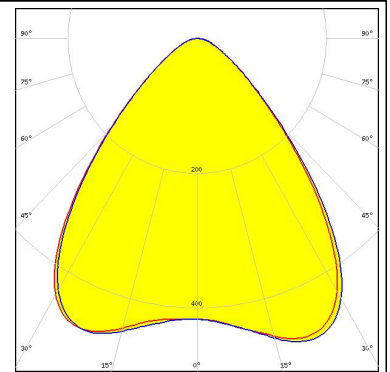
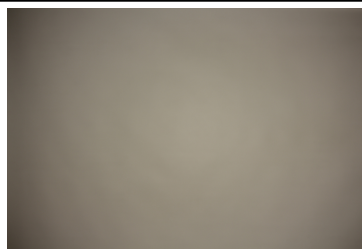

SAMSUNG

LED LC020C
 FWHM 87.0°
 Efficiency 90 %
 Peak intensity 0.480 cd/lm
 Required components:
 LEDiL: F15848_HEKLA-SOCKET-G

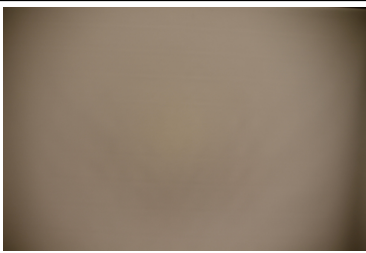
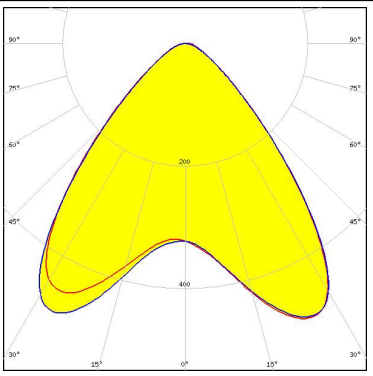

PHOTOMETRIC DATA (MEASURED):

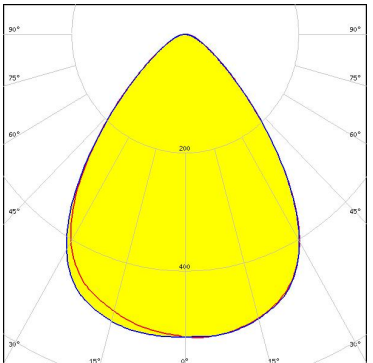
<p> SEOUL SEMICONDUCTOR</p> <p>LED MJT COB LES 6 FWHM 91.0° Efficiency 86 % Peak intensity 0.510 cd/lm Required components: LEDiL: F15255_HEKLA-SOCKET-C</p>		
<p> SEOUL SEMICONDUCTOR</p> <p>LED MJT COB LES 9.8 FWHM 79.0° Efficiency 86 % Peak intensity 0.510 cd/lm Required components: LEDiL: F15255_HEKLA-SOCKET-C</p>		

PHOTOMETRIC DATA (SIMULATED):

TRIDONIC

LED SLE G6 LES10
FWHM 85.0°
Efficiency 93 %
Peak intensity 0.487 cd/lm
Required components:
LEDiL: F15255_HEKLA-SOCKET-C

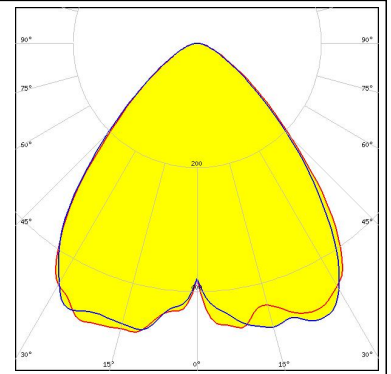

GENERAL INFORMATION:

NOTE: The typical beam angle will be changed by different color, chip size and chip position tolerance. The typical total beam angle is the full angle measured where the luminous intensity is half of the peak value.

Due to use of high power COB's with this product, special attention to proper thermal design is highly recommended. LEDiL has no liability for direct, indirect or consecutive damages arising from the LEDiL products being used outside of the recommended temperature range.

MATERIALS:

As part of our continuous research and improvement processes, and to ensure the best possible quality and availability of our products, LEDiL reserves the right to change material grades without notice.

PRODUCT DATA USER AGREEMENT AND DISCLAIMER:

The measured data in the provided downloadable LEDiL Product Datasheets and Mechanical 2D-Drawings is rounded and provided as reference for planning. LEDiL Oy's optical specifications have been verified by conducting performance testing of the products in accordance with the company's quality system. The reported data are averaged results of multiple measurements with typical variation. LEDiL Oy reserves the right to without prior notification make changes and improvements to its products.

LEDiL Oy assumes neither warranty, nor guarantee nor any other liability of any kind for the contents and correctness of the provided data. The provided data has been generated with highest diligence but the provided data may in reality not represent the complete possible variation range of all intrinsic parameters. Therefore, in certain cases a deviation from the provided data could occur.

LEDiL Oy reserves the right to undertake technical changes of its products without further notification which could lead to changes in the provided data. LEDiL Oy assumes no liability of any kind for the possible deviation from any provided data or any other damage resulting from the usage of the provided data.

The user agrees to this disclaimer and user agreement with the download or usage of the provided files.

LEDiL Oy

Joensuunkatu 13
FI-24240 SALO
Finland

LEDiL Inc.

228 West Page Street
Suite D
Sycamore IL 60178
USA

Local sales and technical support

www.ledil.com/where_to_buy

Shipping locations

Salo, Finland
Hong Kong, China

Distribution Partners

www.ledil.com/where_to_buy