

FDMC8010

MOSFET – N-Channel, POWERTRENCH® 30 V, 75 A, 1.3 mΩ

General Description

This N-Channel MOSFET is produced using ON Semiconductor's advanced POWERTRENCH process that has been especially tailored to minimize the on-state resistance. This device is well suited for applications where ultra low $r_{DS(on)}$ is required in small spaces such as High performance VRM, POL and Oring functions.

Features

- Max $r_{DS(on)}$ = 1.3 mΩ at $V_{GS} = 10\text{ V}$, $I_D = 30\text{ A}$
- Max $r_{DS(on)}$ = 1.8 mΩ at $V_{GS} = 4.5\text{ V}$, $I_D = 25\text{ A}$
- High Performance Technology for Extremely Low $r_{DS(on)}$
- These Devices are Pb-Free and are RoHS Compliant

Applications

- DC – DC Buck Converters
- Point of Load
- High Efficiency Load Switch and Low Side Switching
- Oring FET

MOSFET MAXIMUM RATINGS ($T_A = 25^\circ\text{C}$ Unless Otherwise Noted)

Symbol	Parameter	Ratings	Units
V_{DS}	Drain to Source Voltage	30	V
V_{GS}	Gate to Source Voltage (Note 4)	±20	V
I_D	Drain Current		A
	–Continuous (Package limited) $T_C = 25^\circ\text{C}$	75	
	–Continuous (Silicon limited) $T_C = 25^\circ\text{C}$	166	
	–Continuous $T_A = 25^\circ\text{C}$ (Note 1a)	30	
	–Pulsed	120	
EAS	Single Pulse Avalanche Energy (Note 3)	153	mJ
P_D	Power Dissipation $T_C = 25^\circ\text{C}$	54	W
	Power Dissipation $T_A = 25^\circ\text{C}$ (Note 1a)	2.4	
T_J, T_{STG}	Operating and Storage Junction Temperature Range	–55 to +150	°C

Stresses exceeding those listed in the Maximum Ratings table may damage the device. If any of these limits are exceeded, device functionality should not be assumed, damage may occur and reliability may be affected.

THERMAL CHARACTERISTICS

Symbol	Parameter	Ratings	Unit
$R_{\theta JC}$	Thermal Resistance, Junction to Case	1.3	°C/W
$R_{\theta JA}$	Thermal Resistance, Junction to Ambient (Note 1a)	53	°C/W



ON Semiconductor®

www.onsemi.com

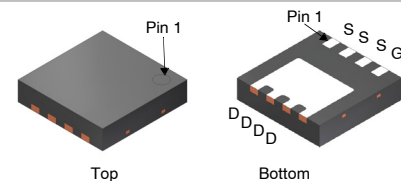

PQFN8 3.3x3.3, 0.65P
CASE 483AW
Power 33

MARKING DIAGRAM

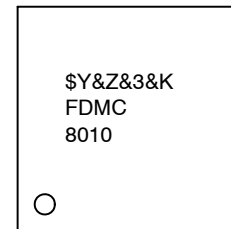

\$Y = ON Semiconductor Logo
&Z = Assembly Plant Code
&3 = Numeric Date Code
&K = Lot Code
FDMC8010 = Specific Device Code

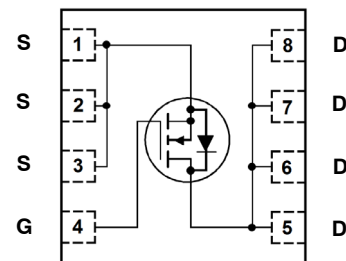

ORDERING INFORMATION

See detailed ordering, marking and shipping information in the package dimensions section on page 2 of this data sheet.

FDMC8010

PACKAGE MARKING AND ORDERING INFORMATION

Device Marking	Device	Package	Reel Size	Tape Width	Quantity
FDMC8010	FDMC8010	Power 33	13"	12 mm	3000 Units

ELECTRICAL CHARACTERISTICS (T_J = 25°C unless otherwise noted)

Symbol	Parameter	Test Condition	Min	Typ	Max	Unit
--------	-----------	----------------	-----	-----	-----	------

OFF CHARACTERISTICS

BV _{DSS}	Drain to Source Breakdown Voltage	I _D = 1 mA, V _{GS} = 0 V	30			V
ΔBV _{DSS} /ΔT _J	Breakdown Voltage Temperature Coefficient	I _D = 1 mA, referenced to 25°C		15		mV/°C
I _{DSS}	Zero Gate Voltage Drain Current	V _{DS} = 24 V, V _{GS} = 0 V			1	μA
I _{GSS}	Gate to Source Leakage Current	V _{GS} = 20 V, V _{DS} = 0 V			100	nA

ON CHARACTERISTICS

V _{GS(th)}	Gate to Source Threshold Voltage	V _{GS} = V _{DS} , I _D = 1 mA	1.2	1.5	2.5	V
ΔV _{GS(th)} /ΔT _J	Gate to Source Threshold Voltage Temperature Coefficient	I _D = 1 mA, referenced to 25°C		-5		mV/°C
r _{DS(on)}	Static Drain to Source On Resistance	V _{GS} = 10 V, I _D = 30 A		0.9	1.3	mΩ
		V _{GS} = 4.5 V, I _D = 25 A		1.3	1.8	
		V _{GS} = 10 V, I _D = 30 A, T _J = 125°C		1.3	2	
g _{FS}	Forward Transconductance	V _{DS} = 5 V, I _D = 30 A		188		S

DYNAMIC CHARACTERISTICS

C _{iss}	Input Capacitance	V _{DS} = 15 V, V _{GS} = 0 V, f = 1 MHz		4405	5860	pF
C _{oss}	Output Capacitance			1570	2090	pF
C _{rss}	Reverse Transfer Capacitance			167	250	pF
R _g	Gate Resistance		0.1	0.5	1.25	Ω

SWITCHING CHARACTERISTICS

t _{d(on)}	Turn-On Delay Time	V _{DD} = 15 V, I _D = 30 A, V _{GS} = 10 V, R _{GEN} = 6 Ω		15	27	ns
t _r	Rise Time			7.5	15	ns
t _{d(off)}	Turn-Off Delay Time			40	64	ns
t _f	Fall Time			5.3	11	ns
Q _g	Total Gate Charge	V _{GS} = 0 V to 10 V	V _{DD} = 15 V I _D = 30 A	67	94	nC
Q _g	Total Gate Charge	V _{GS} = 0 V to 4.5 V		32	45	nC
Q _{gs}	Gate to Source Charge			10		nC
Q _{gd}	Gate to Drain "Miller" Charge			9.5		nC

DRAIN-SOURCE DIODE CHARACTERISTICS

V _{SD}	Source to Drain Diode Forward Voltage	V _{GS} = 0 V, I _S = 2 A (Note 2)		0.6	1.2	V
		V _{GS} = 0 V, I _S = 30 A (Note 2)		0.7	1.2	
t _{rr}	Reverse Recovery Time	I _F = 30 A, di/dt = 100 A/μs		49	78	ns
Q _{rr}	Reverse Recovery Charge			29	46	nC

FDMC8010

NOTES:

1. $R_{\theta JA}$ is determined with the device mounted on a 1 in² pad 2 oz copper pad on a 1.5 x 1.5 in. board of FR-4 material. $R_{\theta JC}$ is guaranteed by design while $R_{\theta CA}$ is determined by the user's board design.

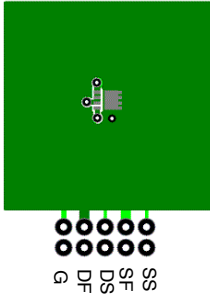

a. 53 °C/W when mounted on a 1 in² pad of 2 oz copper.

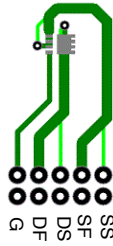

b. 125 °C/W when mounted on a minimum pad of 2 oz copper.

2. Pulse Test: Pulse Width < 300 μ s, Duty cycle < 2.0 %.
3. E_{AS} of 153 mJ is based on starting $T_J = 25$ °C, $L = 0.3$ mH, $I_{AS} = 32$ A, $V_{DD} = 27$ V, $V_{GS} = 10$ V. 100% test at $L = 0.1$ mH, $I_{AS} = 47$ A.
4. As an N-ch device, the negative V_{GS} rating is for low duty cycle pulse occurrence only. No continuous rating is implied.

TYPICAL CHARACTERISTICS

$T_J = 25^\circ\text{C}$ Unless Otherwise Noted

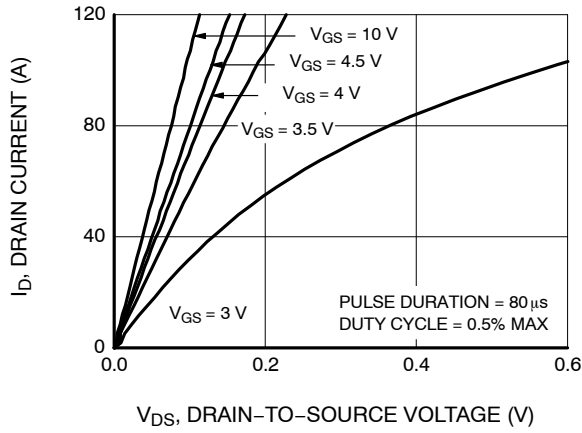

Figure 1. On-Region Characteristics

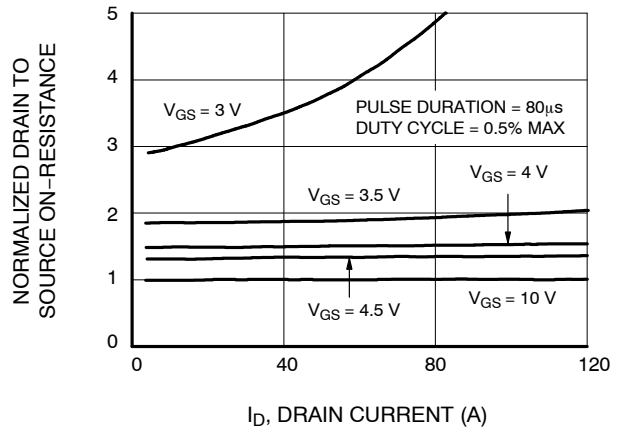

Figure 2. Normalized On-Resistance vs Drain Current and Gate Voltage

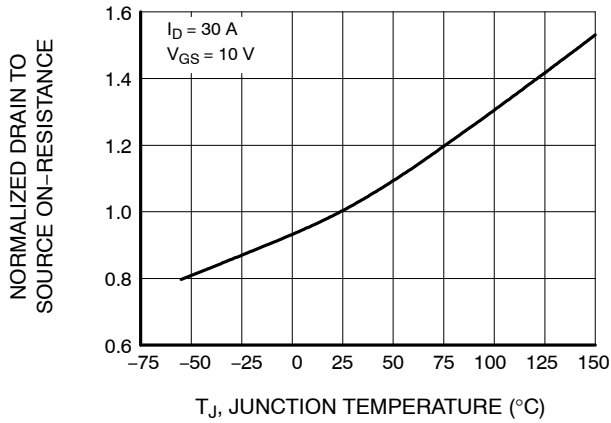

Figure 3. Normalized On Resistance vs Junction Temperature

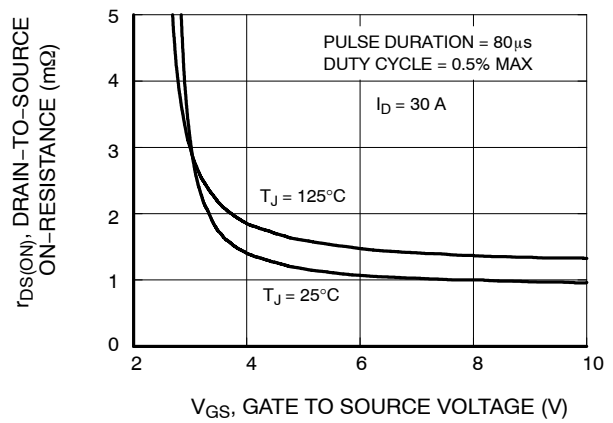

Figure 4. On-Resistance vs Gate to Source Voltage

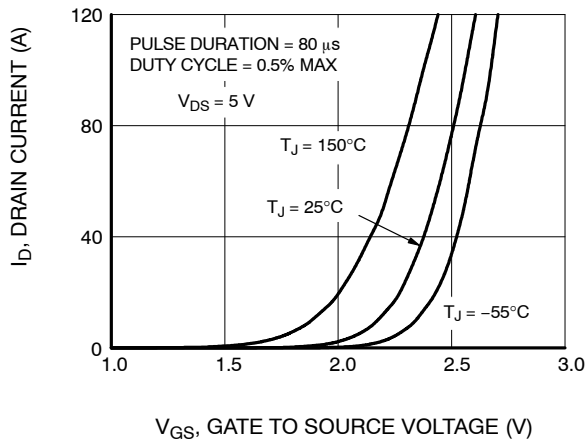

Figure 5. Transfer Characteristics

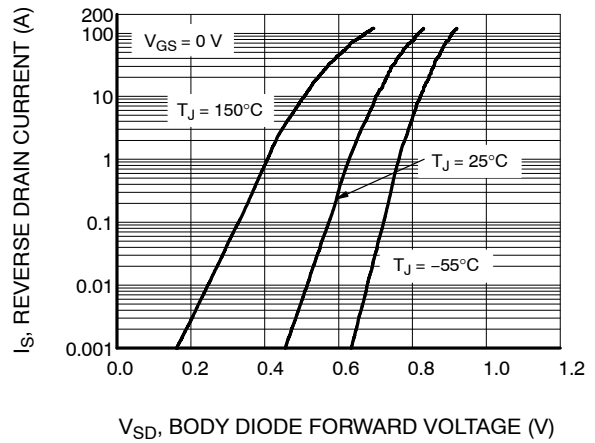

Figure 6. Source to Drain Diode Forward Voltage vs Source Current

TYPICAL CHARACTERISTICS (continued)

$T_J = 25^\circ\text{C}$ Unless Otherwise Noted

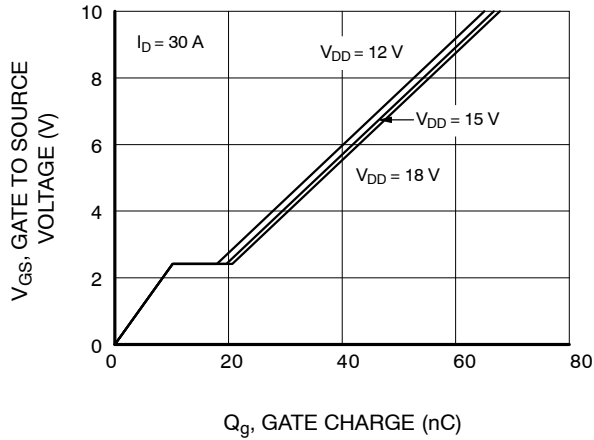

Figure 7. Gate Charge Characteristics

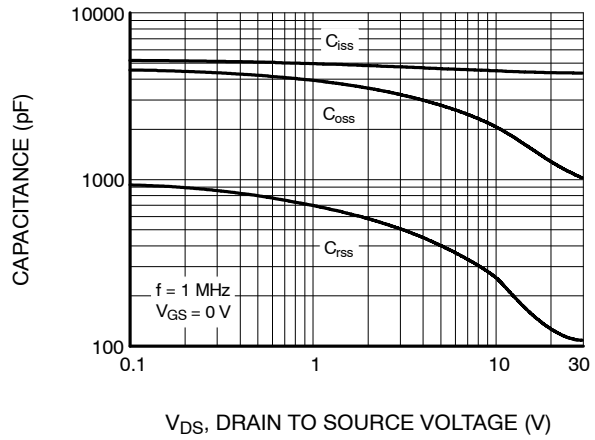

Figure 8. Capacitance vs Drain to Source Voltage

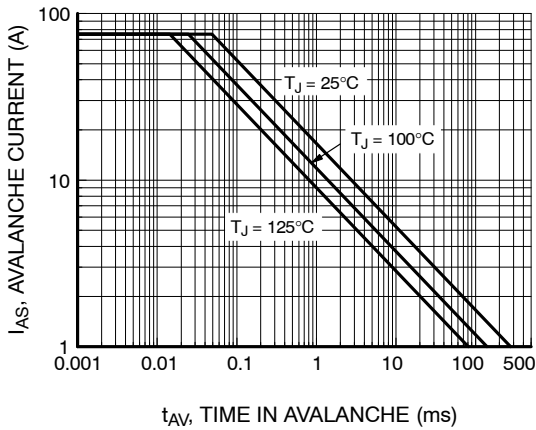

Figure 9. Unclamped Inductive Switching Capability

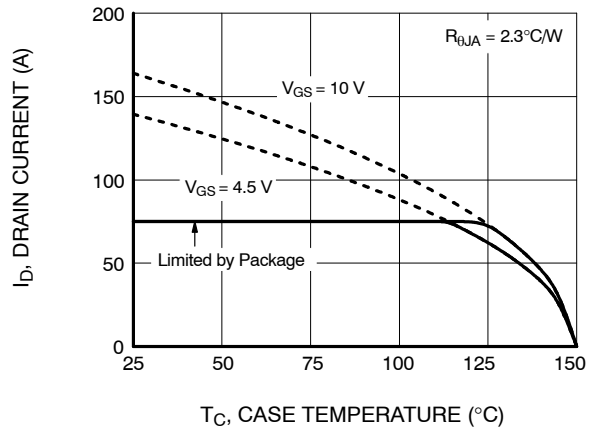

Figure 10. Maximum Continuous Drain Current vs Case Temperature

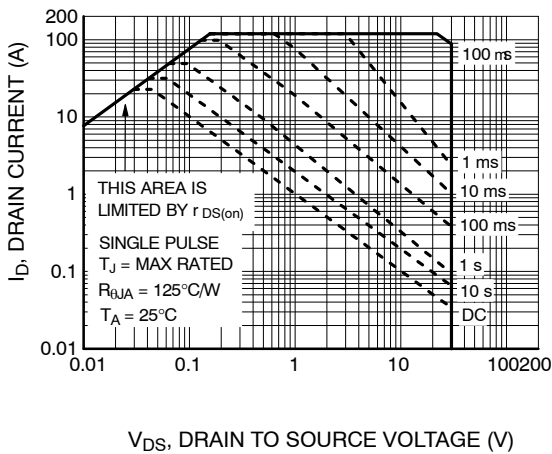

Figure 11. Forward Bias Safe Operating Area

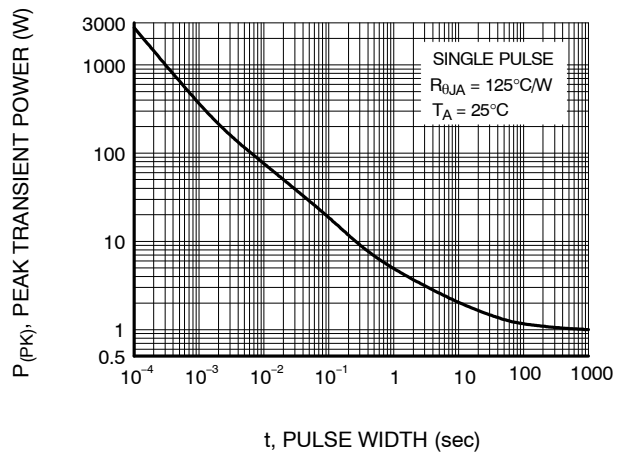

Figure 12. Single Pulse Maximum Power Dissipation

FDMC8010

TYPICAL CHARACTERISTICS (continued)

$T_J = 25^\circ\text{C}$ Unless Otherwise Noted

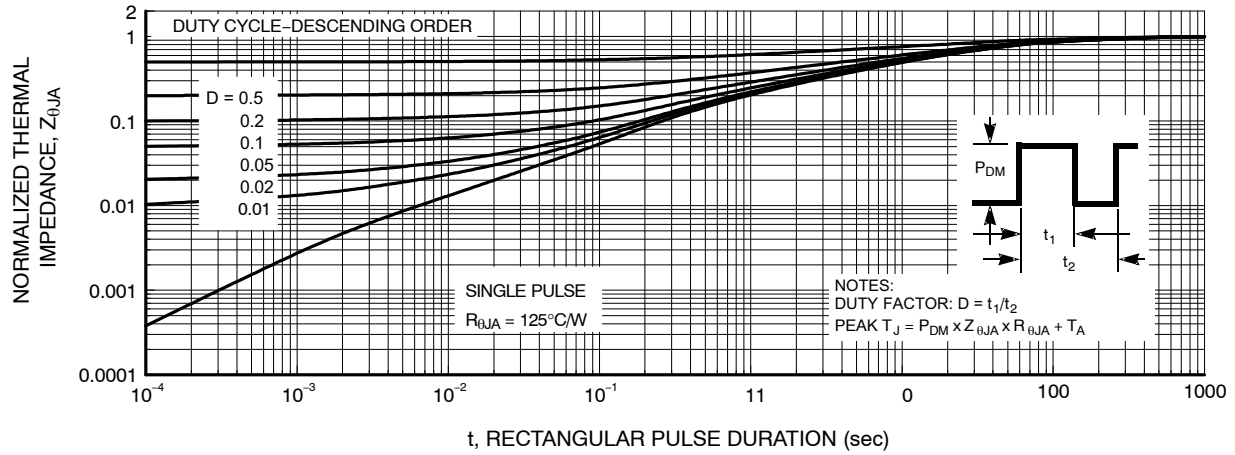

Figure 13. Junction-to-Ambient Transient Thermal Response Curve

POWERTRENCH are registered trademarks of Semiconductor Components Industries, LLC (SCILLC) or its subsidiaries in the United States and/or other countries.

MECHANICAL CASE OUTLINE

PACKAGE DIMENSIONS

PQFN8 3.3X3.3, 0.65P
CASE 483AW
ISSUE O

DATE 30 SEP 2016

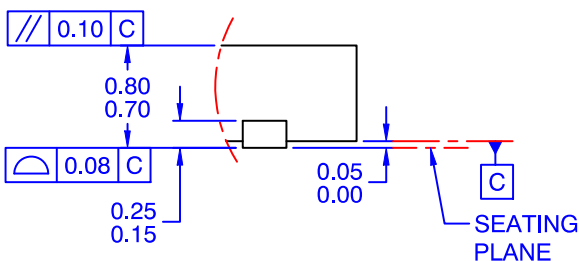
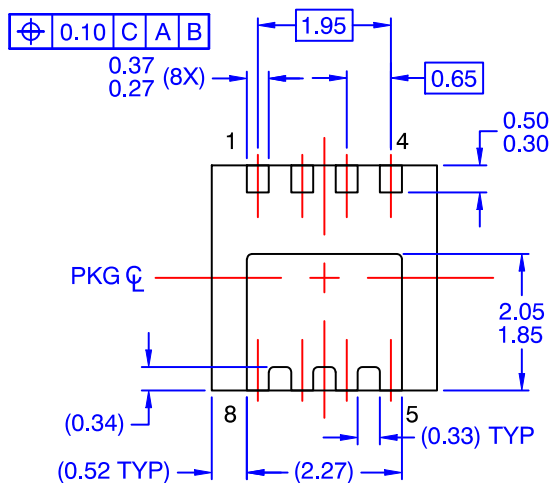
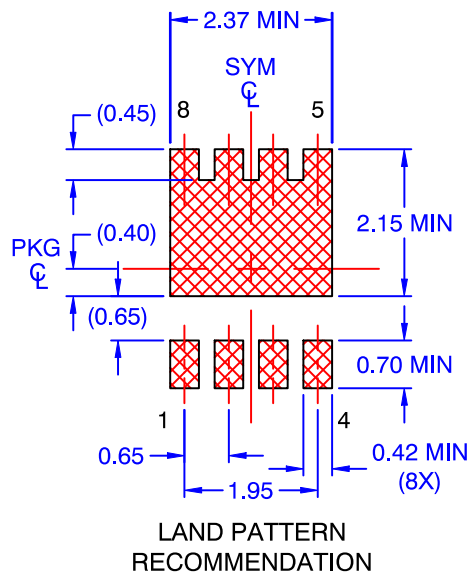
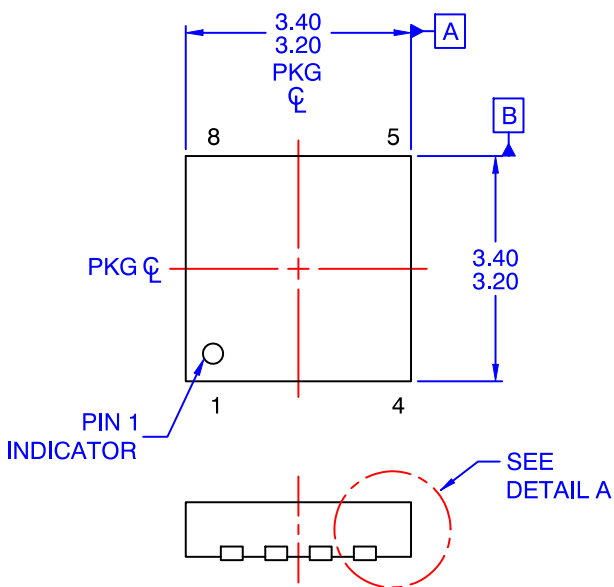

DETAIL A
SCALE: 2X

NOTES: UNLESS OTHERWISE SPECIFIED

- A) PACKAGE STANDARD REFERENCE: JEDEC MO-240, ISSUE A, VAR. BA, DATED OCTOBER 2002.
- B) ALL DIMENSIONS ARE IN MILLIMETERS.
- C) DIMENSIONS DO NOT INCLUDE BURRS OR MOLD FLASH. MOLD FLASH OR BURRS DOES NOT EXCEED 0.10MM.
- D) DIMENSIONING AND TOLERANCING PER ASME Y14.5M-1994.

DOCUMENT NUMBER:	98AON13672G	Electronic versions are uncontrolled except when accessed directly from the Document Repository. Printed versions are uncontrolled except when stamped "CONTROLLED COPY" in red.
STATUS:	ON SEMICONDUCTOR STANDARD	
NEW STANDARD:		
DESCRIPTION:	PQFN8 3.3X3.3, 0.65P	PAGE 1 OF 2



ISSUE	REVISION	DATE
O	RELEASED FOR PRODUCTION FROM FAIRCHILD PQFN08H TO ON SEMICONDUCTOR. REQ. BY I. CAMBALIZA.	30 SEP 2016

ON Semiconductor and  are registered trademarks of Semiconductor Components Industries, LLC (SCILLC). SCILLC reserves the right to make changes without further notice to any products herein. SCILLC makes no warranty, representation or guarantee regarding the suitability of its products for any particular purpose, nor does SCILLC assume any liability arising out of the application or use of any product or circuit, and specifically disclaims any and all liability, including without limitation special, consequential or incidental damages. "Typical" parameters which may be provided in SCILLC data sheets and/or specifications can and do vary in different applications and actual performance may vary over time. All operating parameters, including "Typicals" must be validated for each customer application by customer's technical experts. SCILLC does not convey any license under its patent rights nor the rights of others. SCILLC products are not designed, intended, or authorized for use as components in systems intended for surgical implant into the body, or other applications intended to support or sustain life, or for any other application in which the failure of the SCILLC product could create a situation where personal injury or death may occur. Should Buyer purchase or use SCILLC products for any such unintended or unauthorized application, Buyer shall indemnify and hold SCILLC and its officers, employees, subsidiaries, affiliates, and distributors harmless against all claims, costs, damages, and expenses, and reasonable attorney fees arising out of, directly or indirectly, any claim of personal injury or death associated with such unintended or unauthorized use, even if such claim alleges that SCILLC was negligent regarding the design or manufacture of the part. SCILLC is an Equal Opportunity/Affirmative Action Employer. This literature is subject to all applicable copyright laws and is not for resale in any manner.

ON Semiconductor and  are trademarks of Semiconductor Components Industries, LLC dba ON Semiconductor or its subsidiaries in the United States and/or other countries. ON Semiconductor owns the rights to a number of patents, trademarks, copyrights, trade secrets, and other intellectual property. A listing of ON Semiconductor's product/patent coverage may be accessed at www.onsemi.com/site/pdf/Patent-Marking.pdf. ON Semiconductor reserves the right to make changes without further notice to any products herein. ON Semiconductor makes no warranty, representation or guarantee regarding the suitability of its products for any particular purpose, nor does ON Semiconductor assume any liability arising out of the application or use of any product or circuit, and specifically disclaims any and all liability, including without limitation special, consequential or incidental damages. Buyer is responsible for its products and applications using ON Semiconductor products, including compliance with all laws, regulations and safety requirements or standards, regardless of any support or applications information provided by ON Semiconductor. "Typical" parameters which may be provided in ON Semiconductor data sheets and/or specifications can and do vary in different applications and actual performance may vary over time. All operating parameters, including "Typicals" must be validated for each customer application by customer's technical experts. ON Semiconductor does not convey any license under its patent rights nor the rights of others. ON Semiconductor products are not designed, intended, or authorized for use as a critical component in life support systems or any FDA Class 3 medical devices or medical devices with a same or similar classification in a foreign jurisdiction or any devices intended for implantation in the human body. Should Buyer purchase or use ON Semiconductor products for any such unintended or unauthorized application, Buyer shall indemnify and hold ON Semiconductor and its officers, employees, subsidiaries, affiliates, and distributors harmless against all claims, costs, damages, and expenses, and reasonable attorney fees arising out of, directly or indirectly, any claim of personal injury or death associated with such unintended or unauthorized use, even if such claim alleges that ON Semiconductor was negligent regarding the design or manufacture of the part. ON Semiconductor is an Equal Opportunity/Affirmative Action Employer. This literature is subject to all applicable copyright laws and is not for resale in any manner.

PUBLICATION ORDERING INFORMATION

LITERATURE FULFILLMENT:

Literature Distribution Center for ON Semiconductor
19521 E. 32nd Pkwy, Aurora, Colorado 80011 USA
Phone: 303-675-2175 or 800-344-3860 Toll Free USA/Canada
Fax: 303-675-2176 or 800-344-3867 Toll Free USA/Canada
Email: orderlit@onsemi.com

N. American Technical Support: 800-282-9855 Toll Free
USA/Canada
Europe, Middle East and Africa Technical Support:
Phone: 421 33 790 2910

ON Semiconductor Website: www.onsemi.com

Order Literature: <http://www.onsemi.com/orderlit>

For additional information, please contact your local
Sales Representative