



The Best Ever

# SAFETY LIGHT CURTAIN

F3SG-SR/PG SERIES



PNP

OSSD

CODE

# This series redefines safety at manufacturing sites

Manufacturers now need to manage globalization and flexible production. That's why we have developed our F3SG-SR/PG Series. This series offers a complete lineup of light curtains that comply with global safety standards and a wide range of functionality that covers all aspects from design through to maintenance. The F3SG-SR/PG Series helps manufacturers build safety systems.

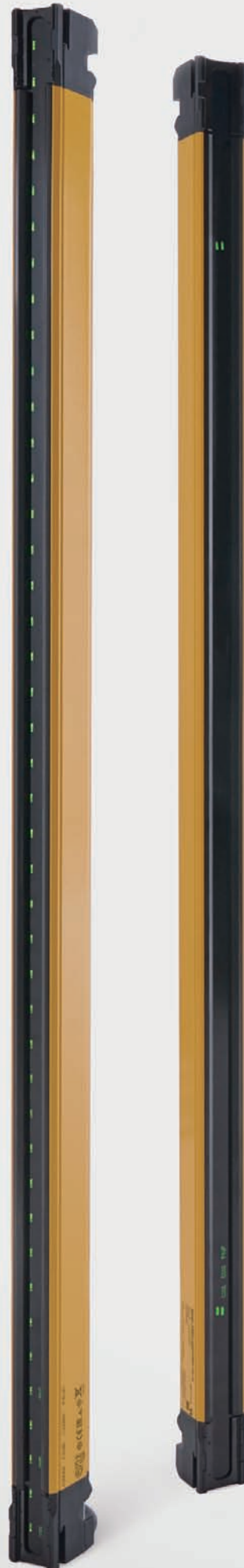

# Build flexible safety systems

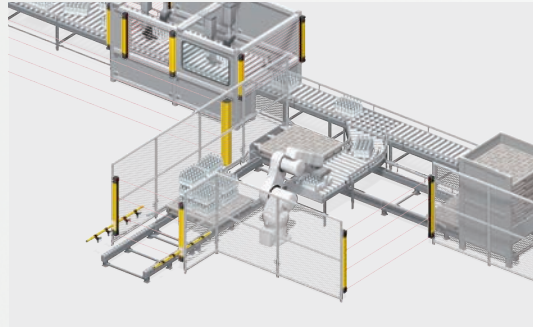

## Design

Easy design of line safety ..... Page 4

Flexible design for equipment ..... Page 6

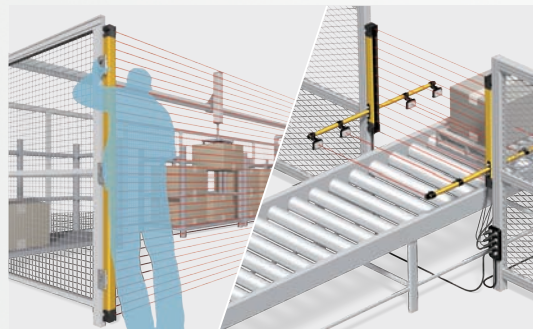

## Set-up

Simple beam adjustment ..... Page 10

Easy installation and angle adjustment ..... Page 11

Various options to reduce wiring ..... Page 12



## Operation

Reduction in unwanted machine stoppages ..... Page 14



## Maintenance

Maintenance with no special skills required ..... Page 16

Quick maintenance through ICT ..... Page 17

# One series covers all protection applications—from machine

Standardize mechanical design across production lines and eliminate complexity of selection and design.

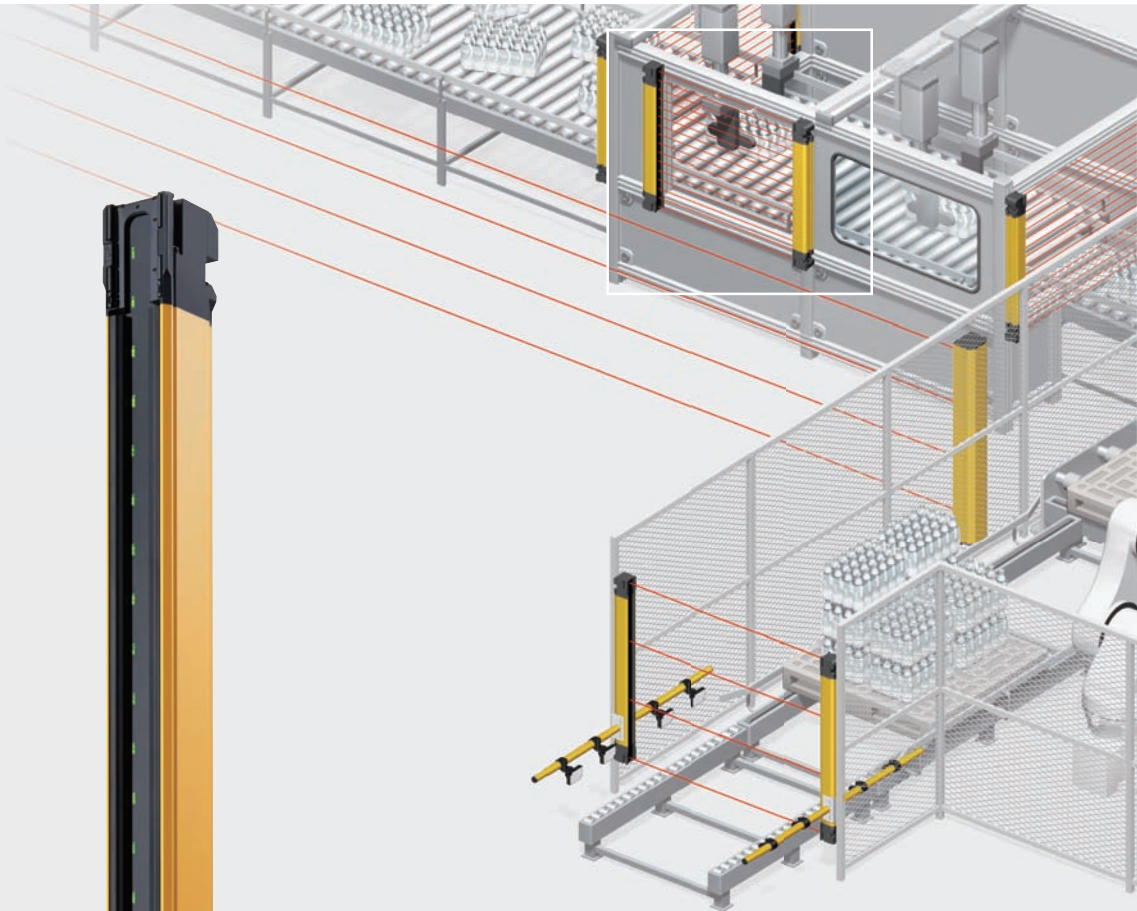

## Protection at machine openings

Safety Light Curtain

# F3SG-SR

NEW

### Finger Protection

Beam gap **10 mm** Detection capability 14-mm dia.

Protective height **160 to 2,000 mm**

Max. operating range **10 m**

### Hand Protection

Beam gap **20 mm** Detection capability 25-mm dia.

Protective height **160 to 2,480 mm**

Max. operating range **20 m**

### Arm/Leg Protection

Beam gap **40 mm** Detection capability 45-mm dia.

Protective height **240 to 1,520 mm**

Max. operating range **20 m**

### Body Protection

Beam gap **80 mm** Detection capability 85-mm dia.

Protective height **280 to 920 mm**

Max. operating range **20 m**

## Common accessories including cables and brackets\*

The light curtains share common accessories for ease of design and retrofitting of production lines.

Intelligent Tap  
F39-SGIT-IL3

Bluetooth® Communication Unit  
F39-SGBT

IO-Link

Bluetooth®

USB Type-C™



Y-Joint Plug/  
Socket Connector  
F39-GCNY2



Muting Sensor Arm Mounter  
F39-FMA

Scheduled for release



Muting Sensor  
Connection Box  
F39-GCN5

Scheduled for release



Floor Mount Column  
F39-ST

Scheduled for release

Mount-Column  
Adjustable Base  
F39-STB

Scheduled for release



Mirror Column  
(for F3SG-SR  
Safety  
Light Curtain)  
F39-SML

Scheduled for release



\* Except for some accessories. See page 37 and following for details.

# openings to perimeters of equipment

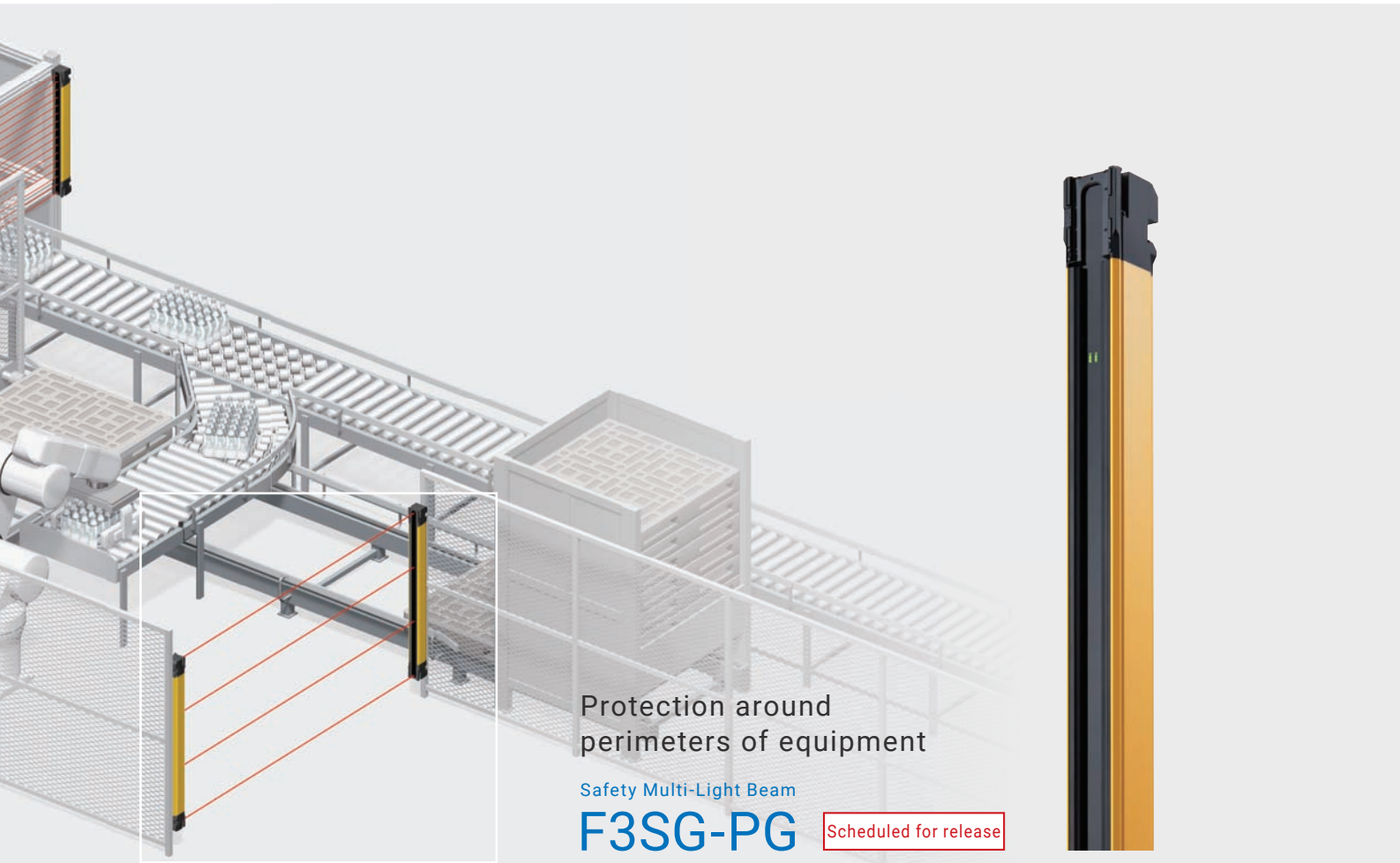

Protection around perimeters of equipment

Safety Multi-Light Beam

**F3SG-PG**

Scheduled for release



Perimeter Access Guarding

Beam gap 300/400/500 mm

Protective height 670 to 1,370 mm

Max. operating range 20 m



Perimeter Guarding Long Range

Beam gap 300/400/500 mm

Protective height 630 to 1,370 mm

Max. operating range 70 m



Perimeter Guarding Deflect Mirror

Beam gap 300/400/500 mm

Protective height 670 to 1,370 mm

Max. operating range 5 m

Mirror Column  
(for F3SG-PG  
Safety  
Multi-Light Beam)  
F39-PML

Scheduled for release

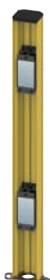

## Helps build safety systems for machines all over the world

This series conforms to worldwide safety standards\*.

\* We will apply for TS Mark, S Mark, and KCs Mark.



PNP/NPN selection by changing the wiring allows you to easily bring and install the light curtain across the world.



The unique tightly sealed structure meets IP67G water and oil resistance and IP69K\*.

\* Scheduled for release



# Industry's broadest\* lineup for flexible production line design

Create flexible design plans to suit your equipment requirements. \* Based on Omron investigation in June 2018.

## Long operating range thanks to unique optical design

The long-distance sensing capability enables reliable detection even in harsh environments.

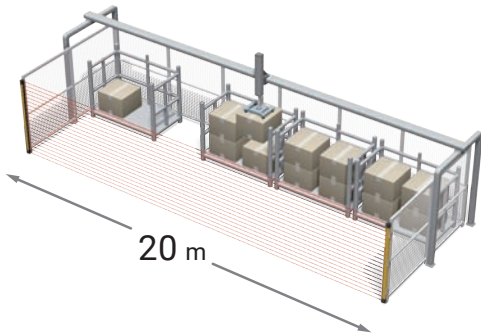

Safety Light Curtain  
**F3SG-SR**  
Series

**20 m**

World's longest class\*

The high-power optical system provides stable detection up to 20 m even in harsh environments.

\* Except for detection capability of 14-mm dia.

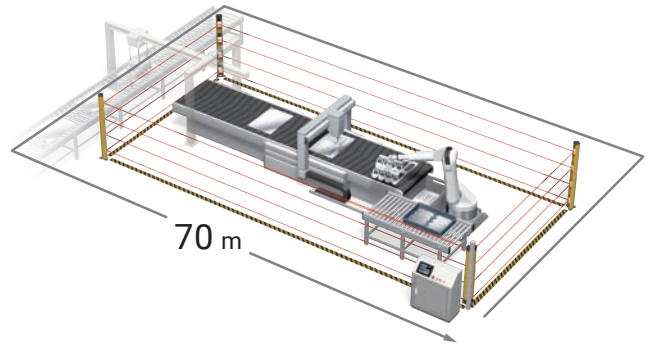

Safety Multi-Light Beam  
**F3SG-PG**  
Series

**70 m**

Patent pending



## Omron's unique compact design

The F3SG-SR Safety Light Curtain and F3SG-PG Safety Multi-Light Beam share the same compact housing. This makes mechanical design more flexible.

\* Compared with Omron ORT's PA46 Perimeter Access Guarding Device. (Based on Omron investigation in June 2018)

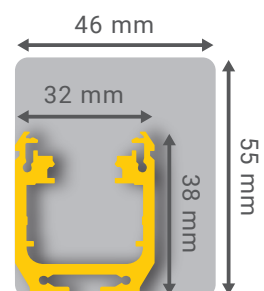

## Easy line layout changes

Simply replace a light curtain using the same accessories because the F3SG-SR Series and F3SG-PG Series share the same housing. There is no need to select and install accessories for a new light curtain.

Example : In order to secure a working space by installing the light curtain closer to the machine, the perimeter guarding model is replaced with the finger protection model

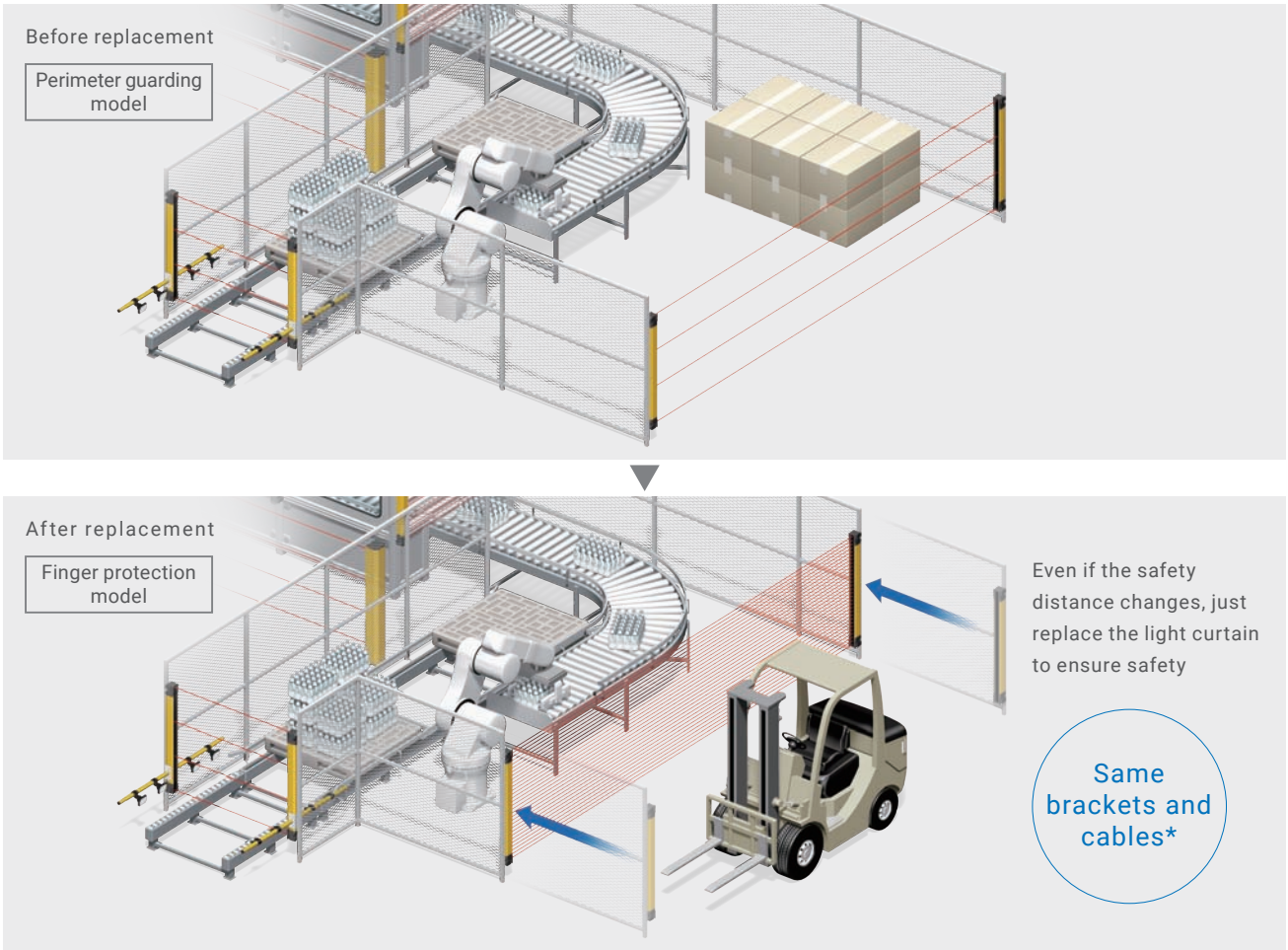

## Just replace the light curtain with the same protective height\*

### F3SG-SR Series lineup

● Standard model ○ Flexible height model (Increments of 40 mm)

Protective height (mm)	160	200	240	280	320	360	400	440	480	520	560	600	640	670	680	720	760	800	840	880	920	960	970	1000	1040	1070	1120	1200	1280	1360	1370
Finger Protection	●	○	○	○	○	○	○	○	○	○	○	○	○	○	○	○	○	○	○	○	○	○	○	○	○	○	○	○	○	○	○
Hand Protection	●	○	○	○	○	○	○	○	○	○	○	○	○	○	○	○	○	○	○	○	○	○	○	○	○	○	○	○	○	○	○
Arm/Leg Protection			●																												
Body Protection																															

Protective height (mm)	1400	1440	1520	1600	1680	1760	1800	1840	1920	2000	2080	2280	2480
Finger Protection	●												
Hand Protection	●	●	●	●	●	●	●	●	●	●	●	●	●
Arm/Leg Protection			●										
Body Protection													

### F3SG-PG Series lineup

Protective height (mm)	160	200	240	280	320	360	400	440	480	520	560	600	640	670	680	720	760	800	840	880	920	960	970	1000	1040	1070	1120	1200	1280	1360	1370
Perimeter Access Guarding																															
Perimeter Guarding Long Range																															
Perimeter Guarding Deflect Mirror																															

\* Except for some models and accessories. See page 37 and following for details.

## Perfect fit

Protective heights are available in increments of 40 mm up to 1,000 mm\*. The perfect protective height for any protected area ensures safety and eliminates the need for additional measures.

**Problem**

The light curtain that does not completely fit the protected area requires additional measures (e.g., adding a protection cover).

**F3SG-SR\***

The flexible height model requires no additional measures.

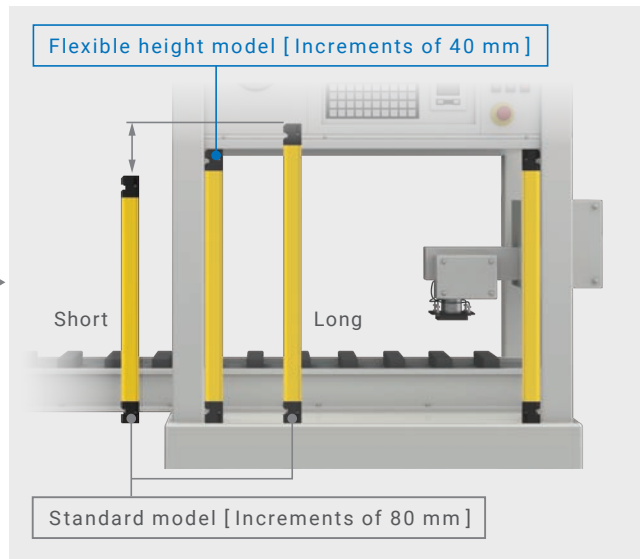
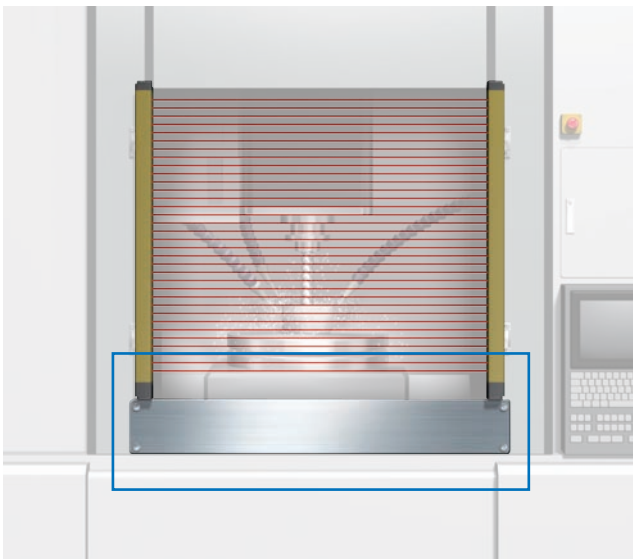

\* F3SG-SR Finger and Hand Protection models only.

## Protection without dead space\*

The F3SG-SR Series eliminates dead space that previously existed even when light curtains are series-connected or U-shape connected. Safer systems can be designed.

**Problem**

Dead space exists at the joint.

**F3SG-SR\***

Eliminates dead space and ensures safety.

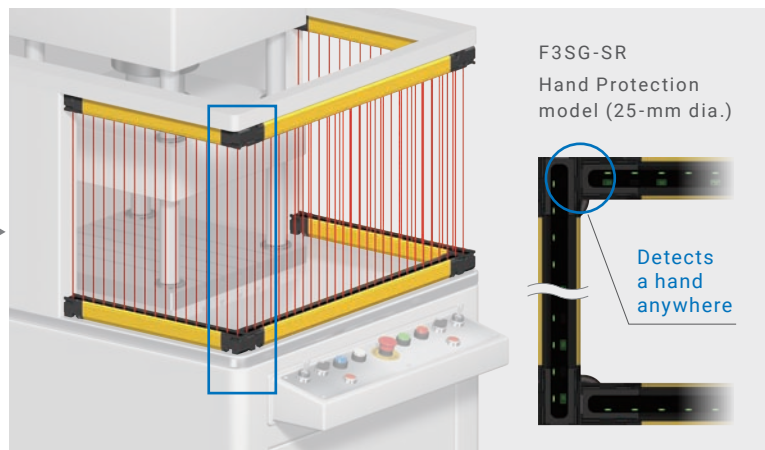
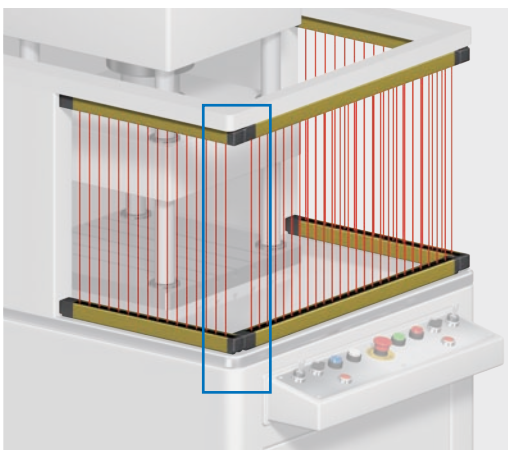

\* Except for F3SG-SR Finger Protection models.

## Simple wiring for flexible design

The F3SG-PG\* Perimeter Guarding Deflect Mirror only requires wiring to one end for protection around perimeters of equipment, reducing wiring duct design and wiring time.

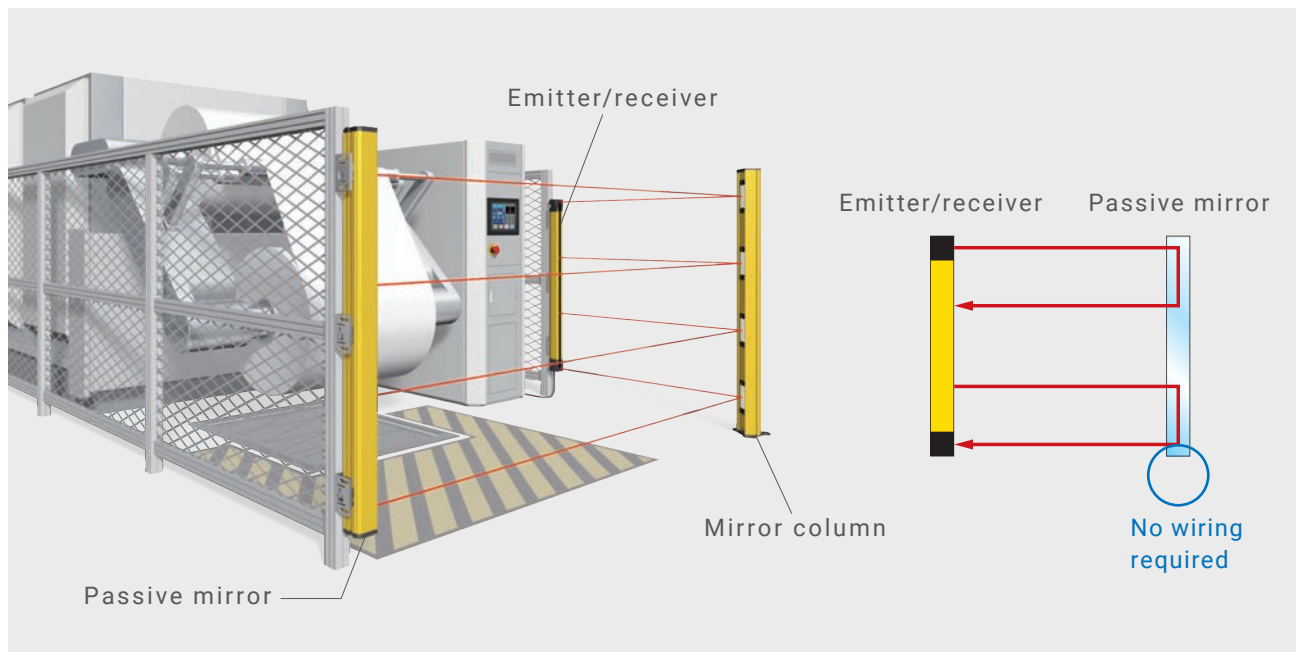

\* Scheduled for release

## Two different synchronization systems

Choose from two different methods of synchronization between the emitter and receiver to suit your equipment.

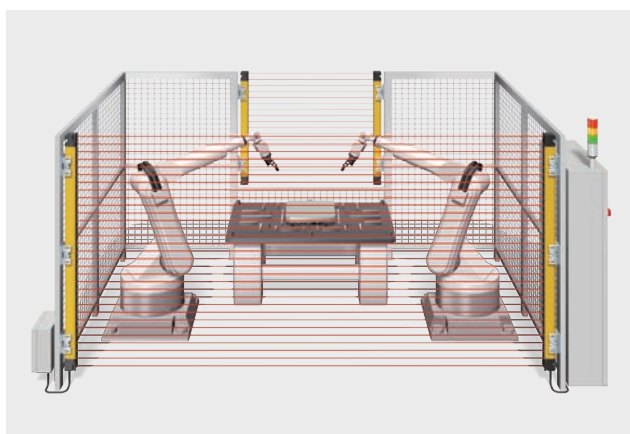

### Optical synchronization

No sync lines are required.  
Connect emitter only to power supply.

Mutual interference prevention : Up to 2 sets

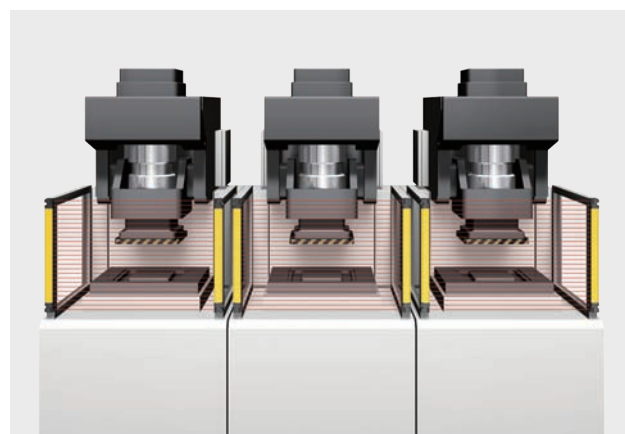
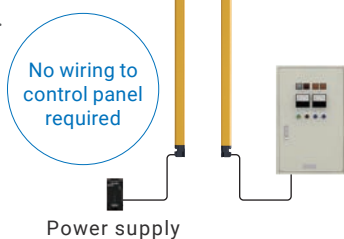

### Wired synchronization

Mutual interference prevention : Up to 3 sets

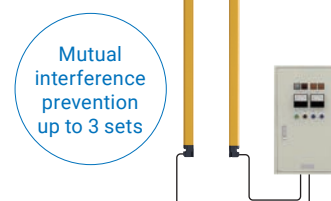

# Color indication of beam status for quick and easy beam adjustment

Reduce beam adjustment time.

## Area Beam Indicator (ABI) for an at-a-glance check of beam status Patent pending

The ON or OFF state of the light curtain and low light intensity can be checked.  
The ABI also facilitates fine adjustment of beams for long-distance sensing.



Easy to see



**Stable state**  
**Green :**  
**Safety outputs ON**  
The beams are unblocked.



**Low light intensity**  
**Orange :**  
**Safety outputs ON**  
Adjust beams or check if the light curtain is dirty.

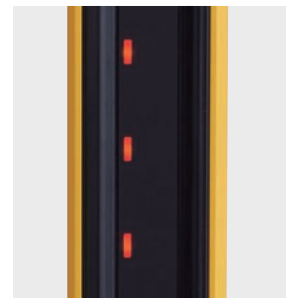

**Beams blocked**  
**Red :**  
**Safety outputs OFF\***  
The beams in the area are blocked.

\* The indicator of an unblocked area is OFF.

Note : Factory default setting.

The images of indicator illumination may vary somewhat from the actual products.

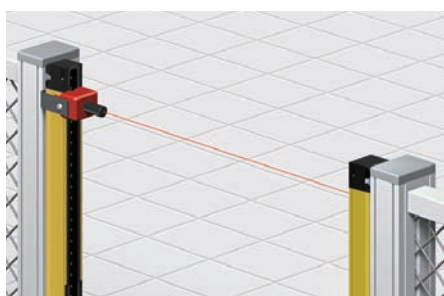

**Laser Alignment Pointer**  
**F39-PTG**



Assists with beam adjustment.  
Easy-to-see laser beam shows the sensor orientation. It can be attached on the spatter protection cover.

# A variety of accessories for easy installation and angle adjustment

Reduce installation time and easily adjust beams after installation without relying on the expertise of experienced engineers.



## Easy beam adjustment after installation

### Problem

It is difficult to adjust beams after the light curtain is installed and the protection cover is attached.



### F3SG-SR/PG

The rugged metal housing of the light curtain does not need a protection cover. Beams can be adjusted using optional brackets.



Adjustable Top / Bottom Bracket  
F3SJ, F3SN Adapter  
F39-LSGTB-SJ

This bracket used at the top and bottom of the light curtain provides horizontal adjustment of  $\pm 22.5^\circ$ .

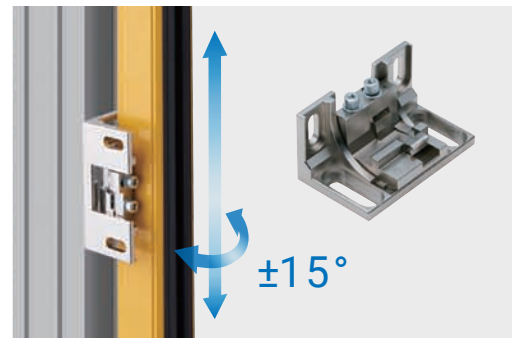

Adjustable Side-Mount Bracket  
(Intermediate Bracket)  
F39-LSGA

This bracket provides horizontal adjustment of  $\pm 15^\circ$  as well as vertical position adjustment.

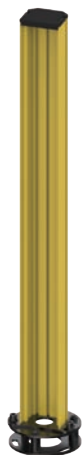

Floor Mount Column  
F39-ST Scheduled for release

This column can be installed independently of equipment or fences, almost anywhere.

Flexible protection

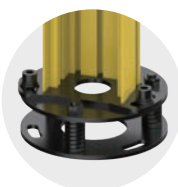

Mount-Column Adjustable Base  
F39-STB

Scheduled for release

Intelligent Tap  
F39-SGIT-IL3

Settings can be copied and pasted between light curtains without using a PC, reducing time and effort to install many machines. Backed up settings are automatically restored at power on.

Setting without PC

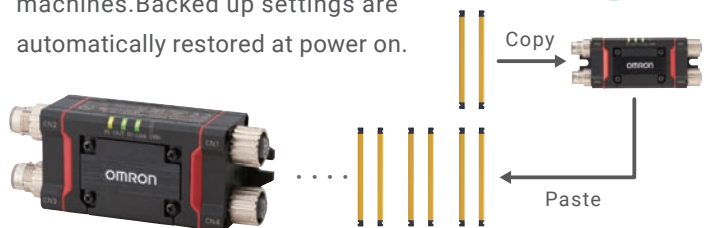

# Reduced wiring system for various equipment

Wiring work during line installation and maintenance can be greatly reduced.

## Simple wiring around large equipment

### Problem

The distance of wiring around large facilities generally becomes long.

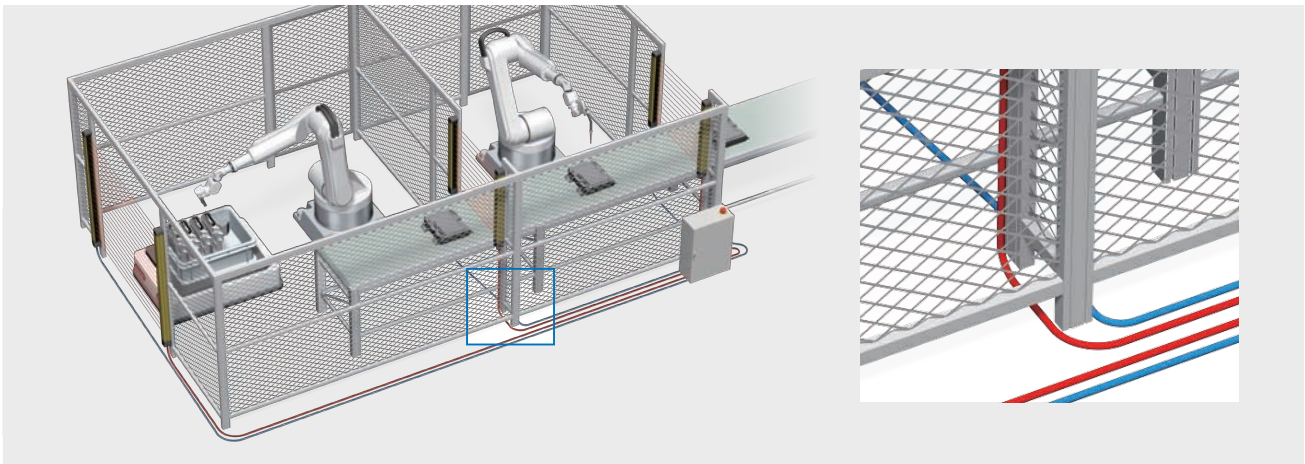

### F3SG-SR/PG

The reduced wiring system reduces the number of cables and terminal blocks and wiring time.

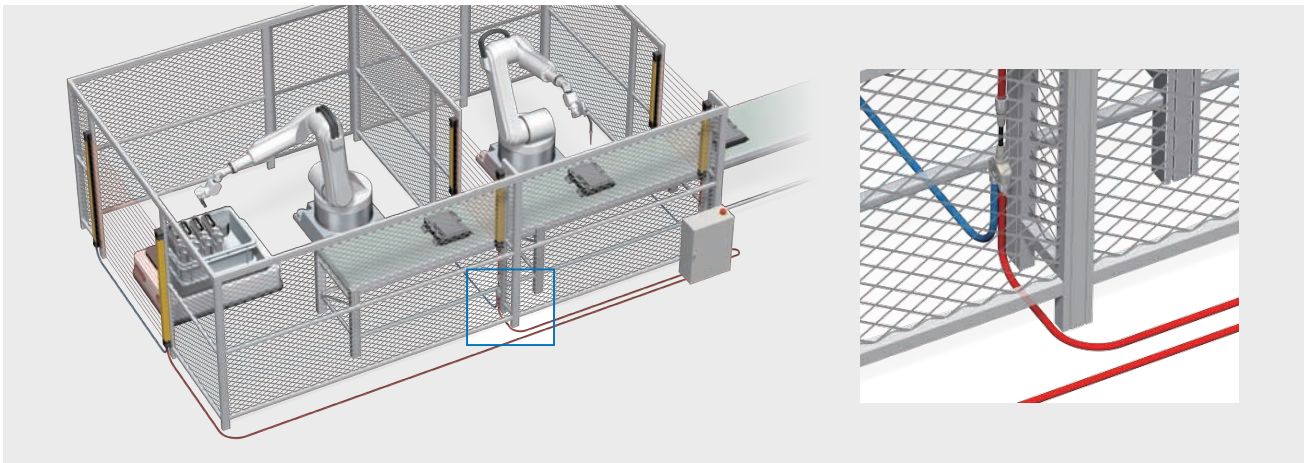

### Reduced wiring connector



Y-Joint Plug /  
Socket Connector  
F39-GCNY2

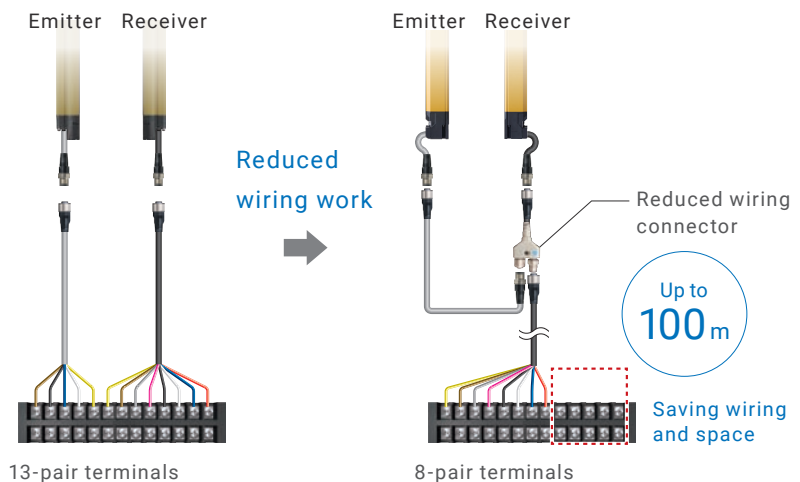

# One cable connection to control panel

Options provide simple wiring for muting.

## Problem

In order to maintain productivity, the light curtains are often used with muting sensors, which makes wiring in the control panel more complicated.

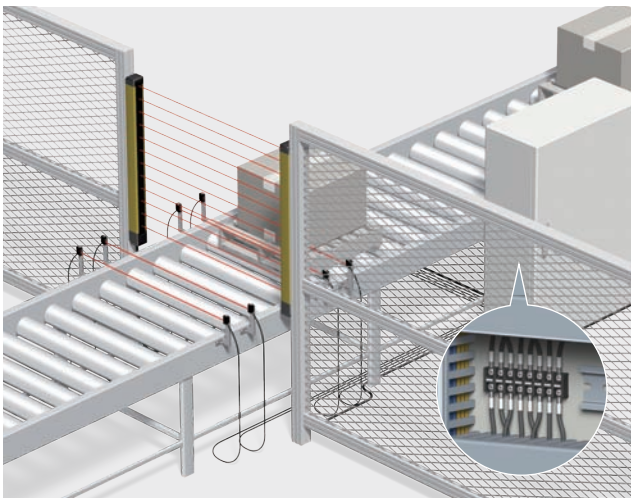

## F3SG-SR/PG

Options to reduce wiring simplify wiring and installation of muting sensors.

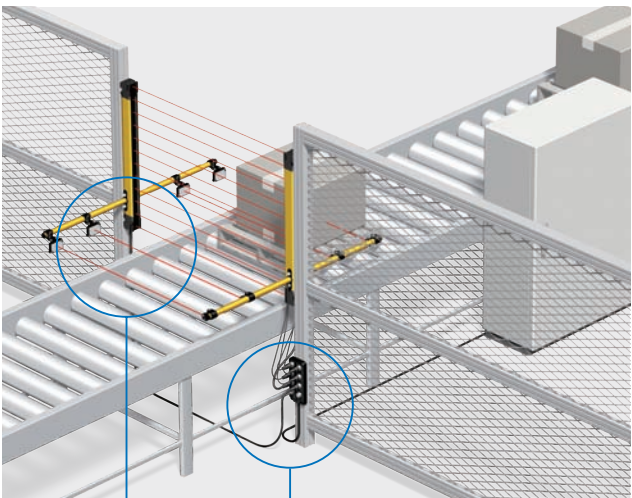

### Muting Sensor Arm Mounter F39-FMA Scheduled for release

The muting sensor arm mounter facilitates installation of a muting sensor.

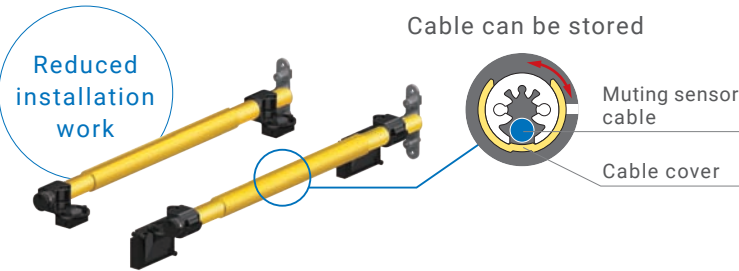

### Muting Sensor Connection Box F39-GCN5 Scheduled for release

The connection box simplifies wiring for muting, and only one cable is used to connect to the control panel.



Note : The E3Z Muting Sensor is sold separately.

Smartclick connectors to quickly connect cables



Smartclick is a registered trademark of OMRON Corporation.

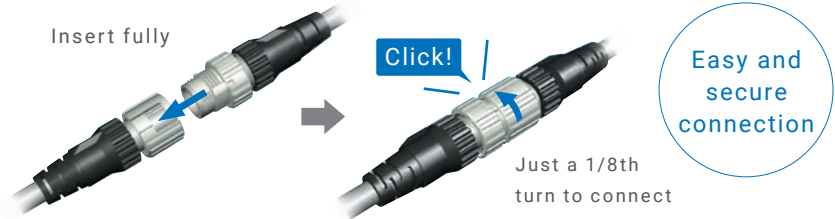

## Robustness for operation in harsh environments

Specifications suitable for use in any environment contribute to stable operation.

Light curtains tend to malfunction in harsh environments where safety measures are required.



Cold storage warehouse

Safety measures cannot be implemented because there is no light curtain that can be used in cold environments.

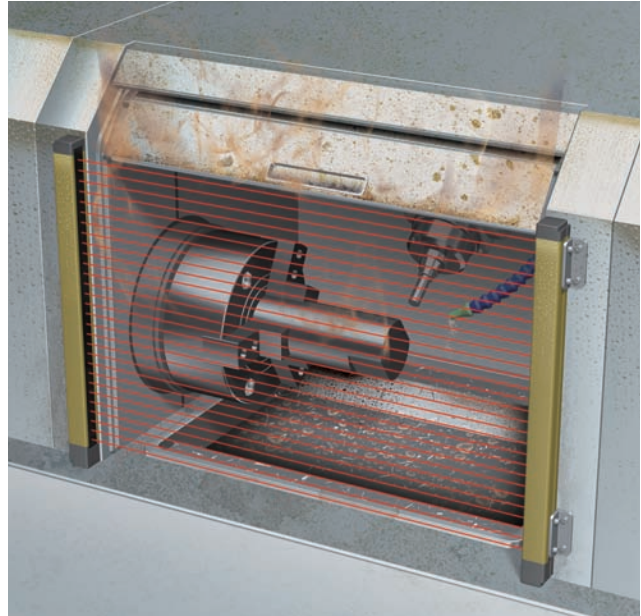

Metal working process

Oil that gets inside the light curtain causes failure at locations where oil mist is present.

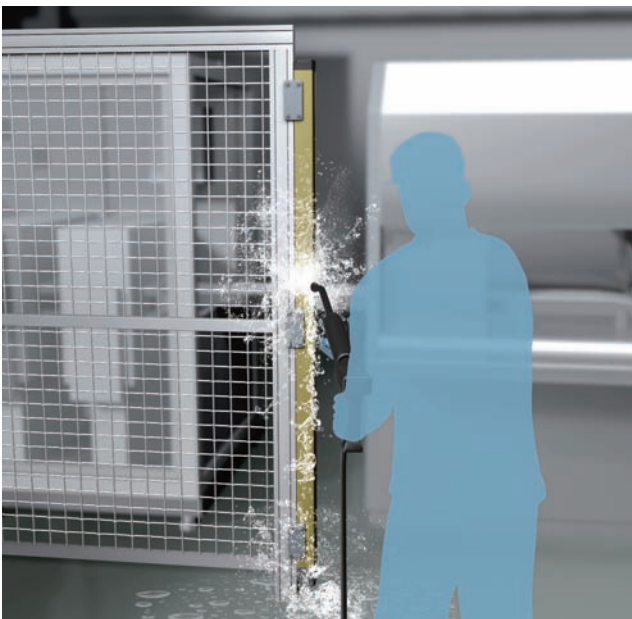

Food processing line

Cleaning solution that gets inside the light curtain during machine wash-down causes failure.

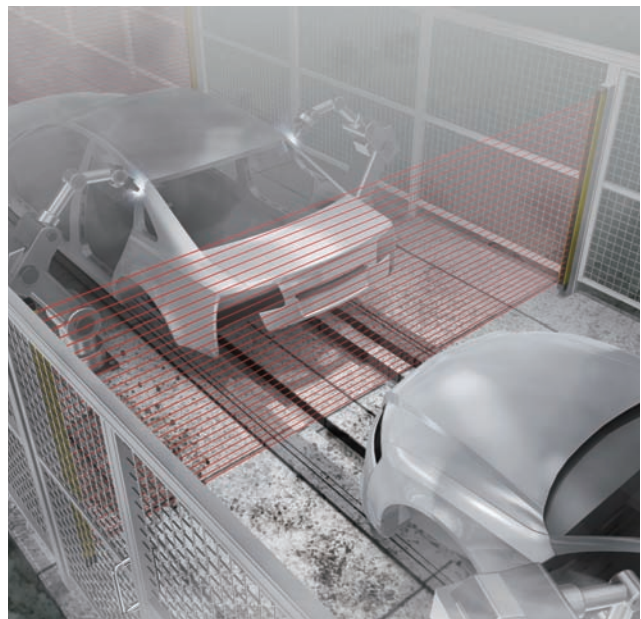

Use in harsh environments

The spattered or dusty optical surface of the light curtain causes a malfunction and sudden machine stop.

Use in temperatures down to **-30°C**

Water/oil resistance **IP67G**

IEC 60529/JIS C 0920 Annex 1



### Tightly sealed structure improved environmental resistance

The unique structure firmly presses the optical surface. Stable sealing performance resists penetration of liquid inside the light curtain, which improves environmental resistance of the housing.

Patent pending

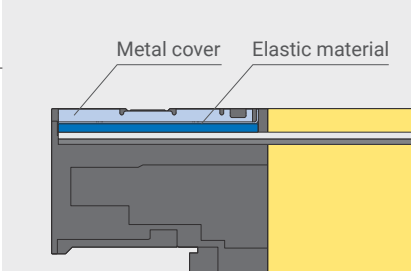

Technology 1 to tightly seal the cap

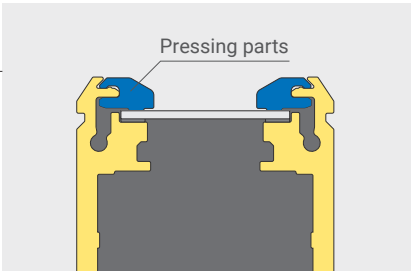

Technology 2 to tightly seal the housing

IP69K model for high-pressure wash-down applications

Scheduled for release



Water resistance **IP69K**

### High-power optical system provides stable detection

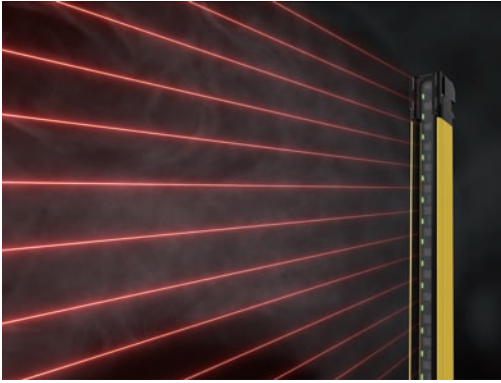

The maximum operating range of the F3SG-SR Safety Light Curtain is 20 m and of the F3SG-PG Safety Multi-Light Beam 70 m. The high-power beam is robust in harsh environments.

Metal housing increases ruggedness

Laser marked information withstands harsh environments

# Easy maintenance

Even inexperienced operators can easily check status and replace light curtains.

## Easy error diagnosis with clear color indicators

The light curtain status can be checked at a glance.



### Status indicator

Clear LED indicators with labels help perform predictive maintenance by dirt detection and determine the optimal replacement timing.

### Colors and patterns indicate the status

Status indicator*	Color	Status
	Red/Illuminated	LOCKOUT state due to a recoverable error
	Red/Blinking	LOCKOUT state due to a replacement-recommended error
	Orange/Illuminated	Safety outputs are instantaneously turned OFF due to ambient light, vibration, or noise
	Orange/Blinking	The Intelligent Tap is in LOCKOUT state

\* The **M** status indicator is used for the 14-mm detection capability model.

### Lamp

Output status can be checked at a glance.

F39-SGLP Scheduled for release



Output information can be assigned to the lamp and ABI.



Status, such as light intensity drop, can be checked from a distance.

For information on other indicators, refer to *Indicator* on page 63 or *Troubleshooting* on page 95.

## Back up and restore settings with Intelligent Tap

Replacement and setting time during maintenance can be reduced to 1/10 or less\*.

### Plug & Work for quick replacement

Install the Intelligent Tap to automatically copy the settings of the replaced light curtain to a new one. Virtually anyone can easily replace light curtains and immediately restart the machine.

Replacement and setting time reduced to 1/10 or less\*



Intelligent Tap  
F39-SGIT-IL3

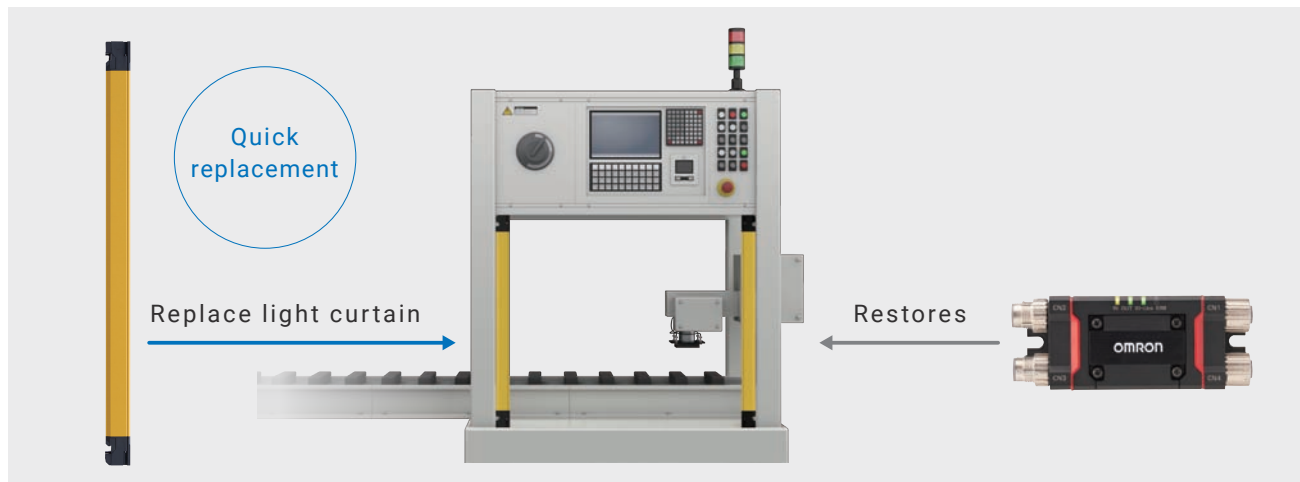

\* Based on Omron investigation in June 2018.

# ICT facilitates more detailed data monitoring

There is no need for a PC on site to check the light curtain status.

## Easy remote monitoring

Various devices can be connected via IO-Link.\*1



No PC required on site

## Easy on-site monitoring

The Bluetooth communication unit allows you to monitor information about device stoppages on mobile devices.



SD Manager 3 Mobile APP



Note 1. Screen images for illustration purposes only.  
2. You need to create screens.

### Process data

- Auxiliary output status \*2
- Muting input status
- Sequence error information
- Unstable state information (each ch)
- Power voltage information
- OSSD output status
- Reset/EDM/override input status
- Instantaneous block information (each ch)
- Light curtain/Intelligent Tap lockout information

### Service data

- Light curtain information
- Light intensity information (1 byte: 0-255)
- Light curtain settings
- Light curtain internal status information
- Intelligent Tap power-on time information
- Intelligent Tap information
- Error log (4 errors)

### Requirements

Android™ 7.0 or higher



Startup screen



Error log screen



Light level monitoring

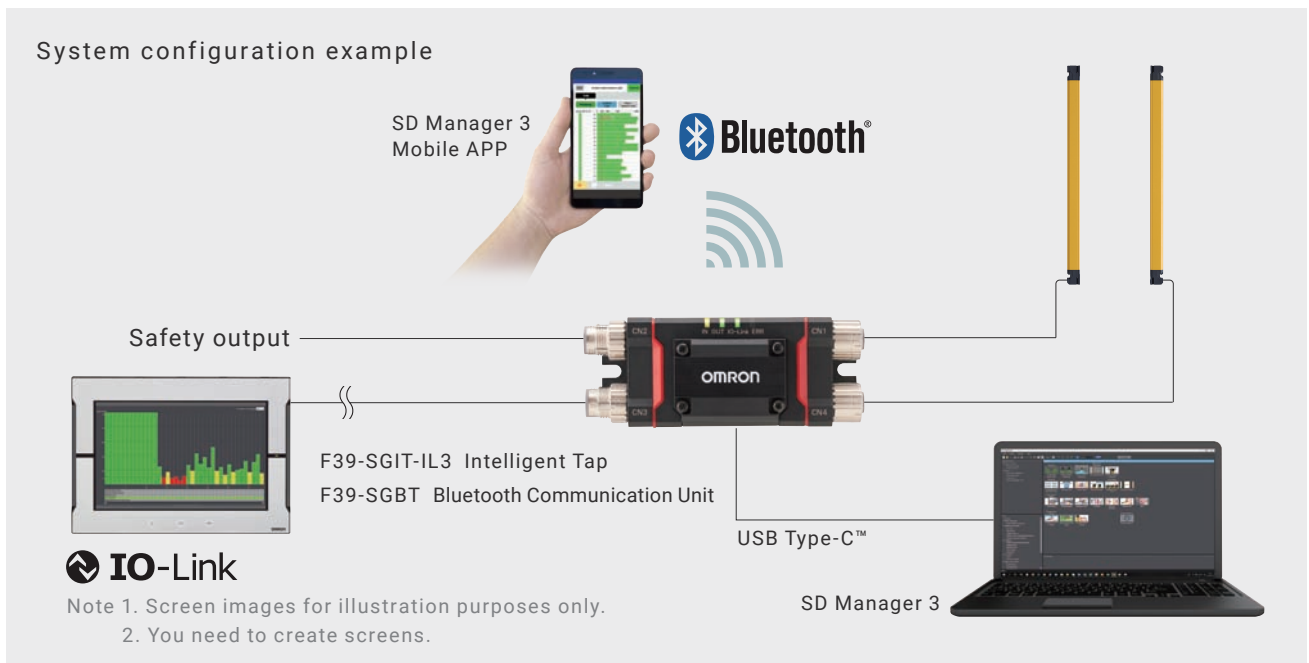

\*1. Refer to the IO-Link Series Catalog (Cat. No. Y229) for details. \*2. Auxiliary output can be set using the SD Manager 3.

# Easy setting via PC software SD Manager 3

The configuration tool allows you to easily monitor status and make settings without using a safety controller.

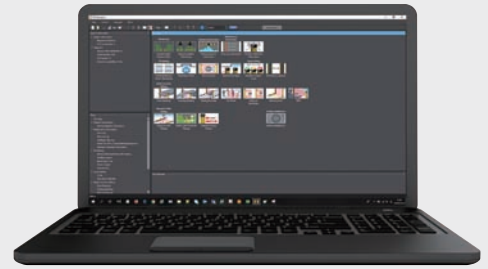

## Manually loaded machining : PSDI



PSDI\*, provided as standard, reduces operator effort and increases productivity

There is no need for the operator to press a two-hand control switch, saving operating time and increasing operating efficiency.

### Single break

The machine restarts when the light curtain is interrupted and reset once.

Example : Manual loading and automatic unloading press

### Double break

The machine restarts when the interruption and reset are repeated twice.

Example : Manual loading and manual unloading press

\* PSDI : Presence Sensing Device Initiation  
Read the *User's Manual* (Cat. No. Z405) before using.  
Note: Comply with laws and regulations in the countries where the machine operates.

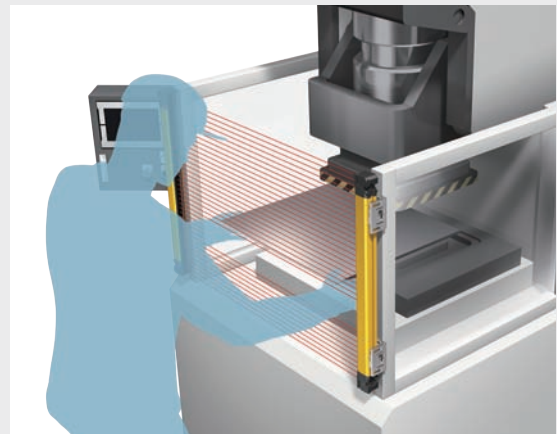

## Dangerous restart prevention : Pre-Reset



The Pre-Reset function prevents possible accidents

This function prevents the restart of equipment while an unseen worker is still near the robot, ensuring operators' safety.

- 1 Press the pre-reset switch inside the hazardous zone.
- ↓
- 2 Get out of the hazardous zone.
- ↓
- 3 Press the reset switch in the control panel to restart the light curtain.  
The machine is ready for restart.

The equipment cannot be restarted until the pre-reset switch of the light curtain is pressed and the light curtain is reset.

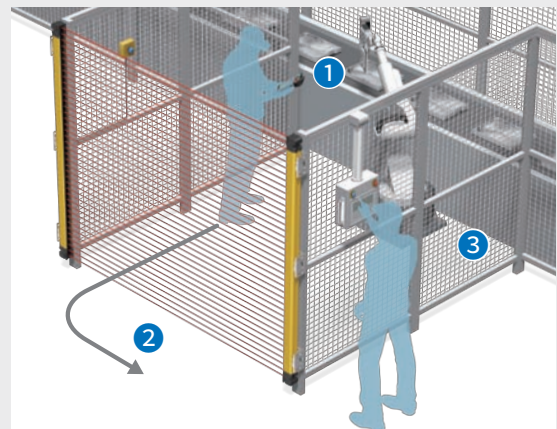

## Ignoring interrupted beams : Reduced Resolution

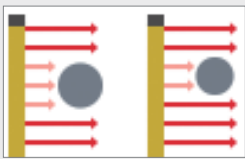

Reduced Resolution changes the detection capability of the light curtain

Even when objects (with a size of 1 to 3 interrupted beams) are present discontinuously, this function ignores them and keeps the safety outputs ON. This helps maintain productivity.

### Example : Arm and body protection

Safety output is kept ON even if worker's finger and an object interrupt 2 beams because they are allowed to enter.

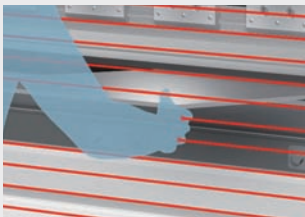

When worker's arm or body, which interrupts 3 beams is detected, safety output is turned OFF.

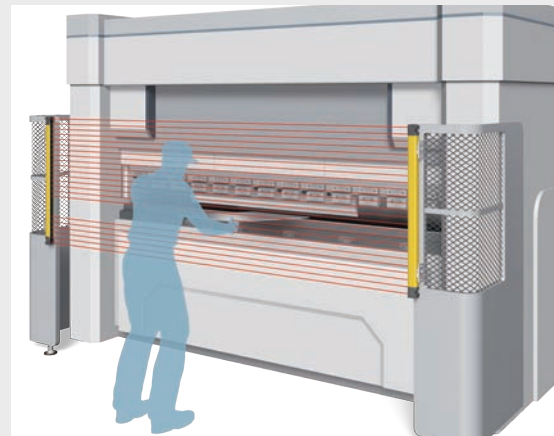

Note : Ensure that the desired safety distance is maintained.

## Built-in standard safety functions

### Monitoring

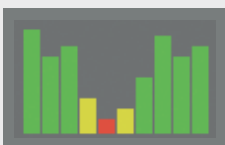

Incident / Ambient Light Level Information

### Safety function setting

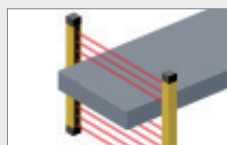

Fixed Blanking

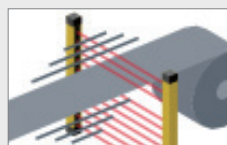

Floating Blanking

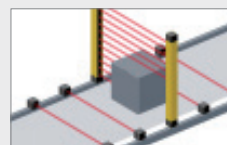

Muting/Override

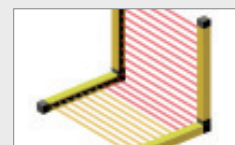

Warning Zone

### I/O setting

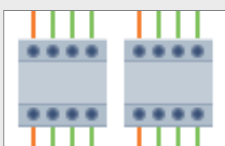

Interlock / External Device Monitoring



Teach-in Input

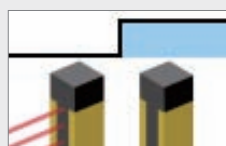

External Test Input

### Operation state change

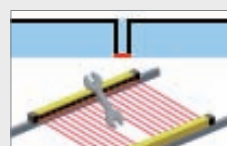









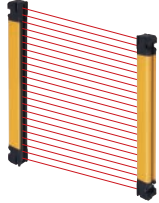
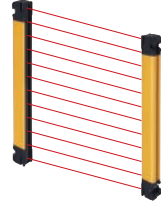
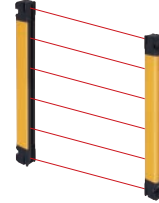
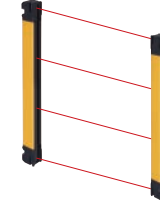



























Response Time Adjustment



Operating Range Selection

# F3SG-SR/PG Series Features and specifications

Series		Protection at machine openings : Safety Light Curtain F3SG-SR				
		Advanced/Standard				
						
Application	 Finger Protection					
	 Hand Protection					
	 Arm/Leg Protection					
	 Body Protection					
Specification	Detection capability	14-mm dia.	25-mm dia.	45-mm dia.	85-mm dia.	
	Beam gap	10 mm	20 mm	40 mm	80 mm	
	Max. operating range	10 m	20 m	20 m	20 m	
	Protective height	160 to 2,000 mm	160 to 2,480 mm	240 to 1,520 mm	280 to 920 mm	
	Number of beams	15 to 199	8 to 124	6 to 38	4 to 12	
	Degree of protection	IP65, IP67, and IP67G				
Feature	Mutual interference prevention	 (No settings required for wired synchronization)				
	PNP/NPN Selection					
	External Test					
	Interlock	 / 				
	Lockout Reset					
	Pre-Reset	 / 				
	PSDI					
	External Device Monitoring (EDM)	 / 				
	Auxiliary Output					
	Muting					
	Blanking	 / 				
	Reduced Resolution					
	Warning Zone					
	Operating Range Selection	 /  / 				
	Response Time Adjustment					
	Area Beam Indicator (ABI)	 * Advanced models only				
Designated Beam Output						
Connection/wiring	Cascade connection	Available	Available	Available	Available	
	Reduced wiring system*1	Available	Available	Available	Available	
Accessory	Laser Alignment Pointer	Available	Available	Available	Available	
	Lamp <span style="border: 1px solid red; padding: 2px;">Scheduled for release</span>	Available	Available	Available	Available	
	IP69K model <span style="border: 1px solid red; padding: 2px;">Scheduled for release</span>	Available	Available	Not available	Not available	

 Setting by DIP switch on Intelligent Tap     Setting by configuration tool SD Manager 3     Setting by wiring  
 Setting by end cap

Protection around perimeters of equipment : Safety Multi-Light Beam F3SG-PG <span style="border: 1px solid red; padding: 2px;">Scheduled for release</span>			Series		
Perimeter Access Guarding	Perimeter Guarding Long Range	Perimeter Guarding Deflect Mirror			
			Finger Protection	Application	
			Hand Protection		
			Arm/Leg Protection		
			Body Protection		
---			Detection capability	Specification	
300 mm/400 mm/500 mm			Beam gap		
20 m	70 m	5 m *2	Max. operating range		
670 to 1,370 mm			Protective height		
2, 3 and 4		2 and 4	Number of beams		
IP65 and IP67			Degree of protection		
(No settings required for wired synchronization)			Mutual interference prevention	Feature	
			PNP/NPN Selection		
		Not supported	External Test		
			Interlock		
			Lockout Reset		
			Pre-Reset		
Not supported			PSDI		
			External Device Monitoring (EDM)		
			Auxiliary Output		
			Muting		
Not supported			Blanking		
Not supported			Reduced Resolution		
Not supported			Warning Zone		
Not supported		Not supported	Operating Range Selection		
			Response Time Adjustment		
			Area Beam Indicator (ABI)		
			Designated Beam Output		
Not available	Not available	Not available	Cascade connection	Connection/ wiring	
Available	Available	Available	Reduced wiring system*1		
Available	Available	Available	Laser Alignment Pointer	Accessory	
Available	Available	Available *3	Lamp <span style="border: 1px solid red; padding: 2px;">Scheduled for release</span>		
Available	Not available	Not available	IP69K model <span style="border: 1px solid red; padding: 2px;">Scheduled for release</span>		

\*1. The reduced wiring system includes the Y-joint plug/socket connector, reset switch connector, and muting sensor connection box (Scheduled for release).

\*2. Varies depending on the model.

\*3. Cannot be mounted on the passive mirror.

Safety Light Curtain

# F3SG-SR/PG Series Product selection

Choose your safety light curtain and accessories from our F3SG Series through a 4-step process.

STEP 1  
Choose a safety  
light curtain

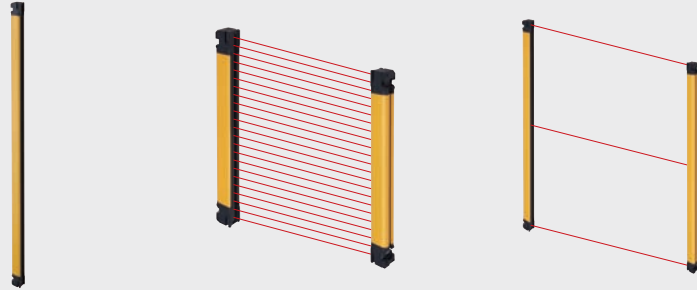

STEP 2  
Choose  
a mounting  
bracket

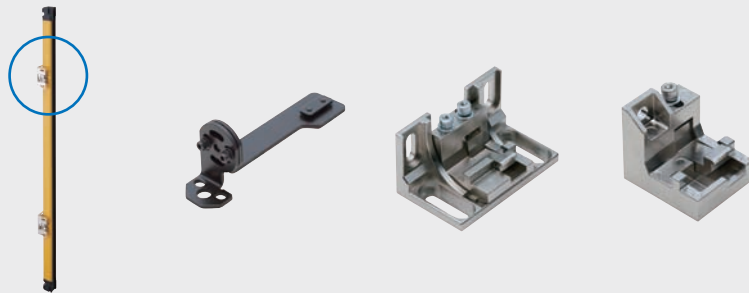

STEP 3  
Choose a wiring  
method



STEP 4  
Choose the  
accessories  
you need



## STEP 1 Choose a safety light curtain

Select a light curtain to suit your application.

### Protection at machine openings

**SR**

Page 24

Safety Light Curtain  
F3SG-SR Series

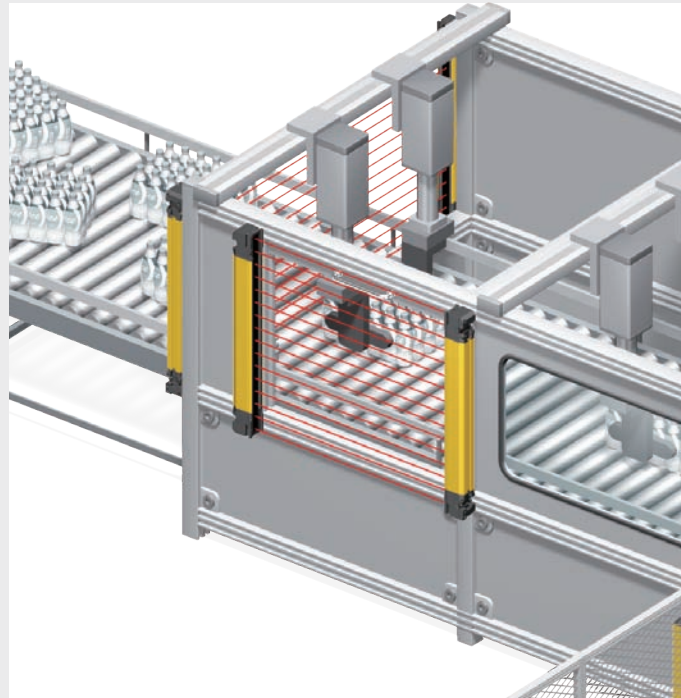

### Protection around perimeters of equipment

**PG**

Page 26

Safety Multi-Light Beam  
F3SG-PG Series

Scheduled for release

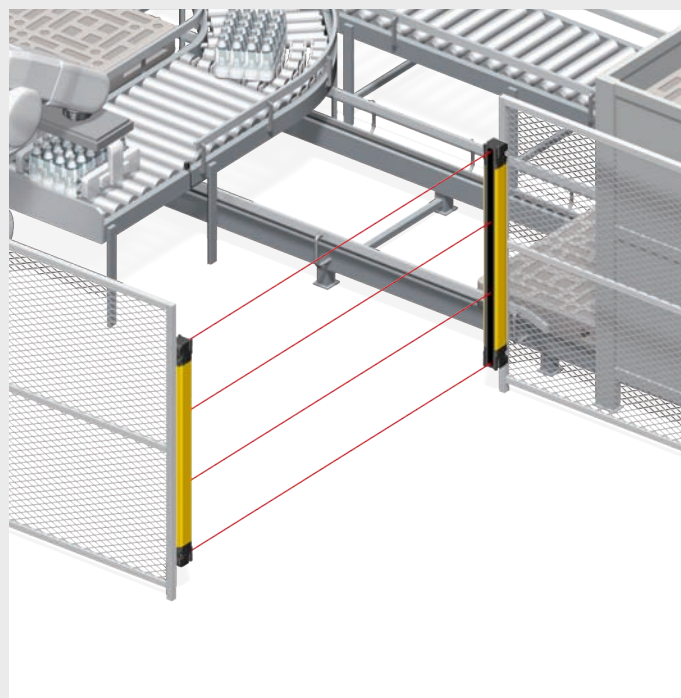

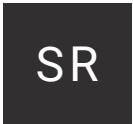

Complete the model number.

F3SG-4SR      -   -  -

①
③
②
④
⑤

① Select an application.

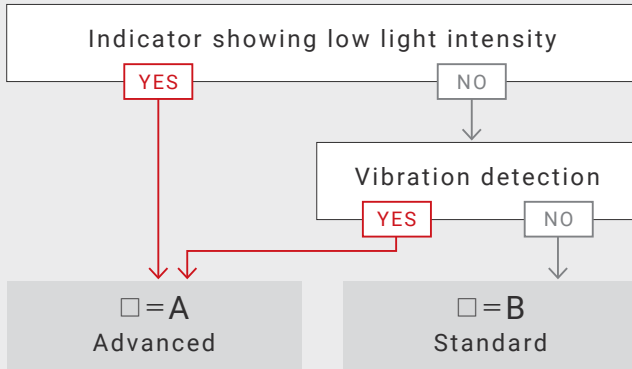

② Select detection capability.

Type	②
<p><b>Finger Protection</b></p> <p>Detection capability 14-mm dia.</p>	☐☐ = 14
<p><b>Hand Protection</b></p> <p>Detection capability 25-mm dia.</p>	☐☐ = 25
<p><b>Arm/Leg Protection</b></p> <p>Detection capability 45-mm dia.</p>	☐☐ = 45
<p><b>Body Protection</b></p> <p>Detection capability 85-mm dia.</p>	☐☐ = 85

③ Select protective height.\*1

Finger Protection

Protective height (mm)	Number of beams	③
160	15	☐☐☐☐ = 0160
240	23	☐☐☐☐ = 0240
320	31	☐☐☐☐ = 0320
400	39	☐☐☐☐ = 0400
480	47	☐☐☐☐ = 0480
560	55	☐☐☐☐ = 0560
640	63	☐☐☐☐ = 0640
800	79	☐☐☐☐ = 0800
1000	99	☐☐☐☐ = 1000
1200	119	☐☐☐☐ = 1200
1400	139	☐☐☐☐ = 1400
1600	159	☐☐☐☐ = 1600
1800	179	☐☐☐☐ = 1800
2000	199	☐☐☐☐ = 2000

Arm/Leg Protection

Protective height (mm)	Number of beams	③
240	6	☐☐☐☐ = 0240
400	10	☐☐☐☐ = 0400
560	14	☐☐☐☐ = 0560
720	18	☐☐☐☐ = 0720
880	22	☐☐☐☐ = 0880
1200	30	☐☐☐☐ = 1200
1520	38	☐☐☐☐ = 1520

Body Protection

Protective height (mm)	Number of beams	③
280	4	☐☐☐☐ = 0280
440	6	☐☐☐☐ = 0440
600	8	☐☐☐☐ = 0600
760	10	☐☐☐☐ = 0760
920	12	☐☐☐☐ = 0920

**4 5** Select an option.\*<sup>1</sup>

## Hand Protection

Protective height (mm)	Number of beams	<b>3</b>
160	8	<input type="checkbox"/> <input type="checkbox"/> <input type="checkbox"/> <input type="checkbox"/> =0160
240	12	<input type="checkbox"/> <input type="checkbox"/> <input type="checkbox"/> <input type="checkbox"/> =0240
320	16	<input type="checkbox"/> <input type="checkbox"/> <input type="checkbox"/> <input type="checkbox"/> =0320
400	20	<input type="checkbox"/> <input type="checkbox"/> <input type="checkbox"/> <input type="checkbox"/> =0400
480	24	<input type="checkbox"/> <input type="checkbox"/> <input type="checkbox"/> <input type="checkbox"/> =0480
560	28	<input type="checkbox"/> <input type="checkbox"/> <input type="checkbox"/> <input type="checkbox"/> =0560
640	32	<input type="checkbox"/> <input type="checkbox"/> <input type="checkbox"/> <input type="checkbox"/> =0640
720	36	<input type="checkbox"/> <input type="checkbox"/> <input type="checkbox"/> <input type="checkbox"/> =0720
800	40	<input type="checkbox"/> <input type="checkbox"/> <input type="checkbox"/> <input type="checkbox"/> =0800
880	44	<input type="checkbox"/> <input type="checkbox"/> <input type="checkbox"/> <input type="checkbox"/> =0880
960	48	<input type="checkbox"/> <input type="checkbox"/> <input type="checkbox"/> <input type="checkbox"/> =0960
1040	52	<input type="checkbox"/> <input type="checkbox"/> <input type="checkbox"/> <input type="checkbox"/> =1040
1120	56	<input type="checkbox"/> <input type="checkbox"/> <input type="checkbox"/> <input type="checkbox"/> =1120
1200	60	<input type="checkbox"/> <input type="checkbox"/> <input type="checkbox"/> <input type="checkbox"/> =1200
1280	64	<input type="checkbox"/> <input type="checkbox"/> <input type="checkbox"/> <input type="checkbox"/> =1280
1360	68	<input type="checkbox"/> <input type="checkbox"/> <input type="checkbox"/> <input type="checkbox"/> =1360
1440	72	<input type="checkbox"/> <input type="checkbox"/> <input type="checkbox"/> <input type="checkbox"/> =1440
1520	76	<input type="checkbox"/> <input type="checkbox"/> <input type="checkbox"/> <input type="checkbox"/> =1520
1600	80	<input type="checkbox"/> <input type="checkbox"/> <input type="checkbox"/> <input type="checkbox"/> =1600
1680	84	<input type="checkbox"/> <input type="checkbox"/> <input type="checkbox"/> <input type="checkbox"/> =1680
1760	88	<input type="checkbox"/> <input type="checkbox"/> <input type="checkbox"/> <input type="checkbox"/> =1760
1840	92	<input type="checkbox"/> <input type="checkbox"/> <input type="checkbox"/> <input type="checkbox"/> =1840
1920	96	<input type="checkbox"/> <input type="checkbox"/> <input type="checkbox"/> <input type="checkbox"/> =1920
2080	104	<input type="checkbox"/> <input type="checkbox"/> <input type="checkbox"/> <input type="checkbox"/> =2080
2280	114	<input type="checkbox"/> <input type="checkbox"/> <input type="checkbox"/> <input type="checkbox"/> =2280
2480	124	<input type="checkbox"/> <input type="checkbox"/> <input type="checkbox"/> <input type="checkbox"/> =2480

Type	<b>4</b>
Set of emitter and receiver	Blank
Emitter * <sup>2</sup>	<input type="checkbox"/> = L
Receiver * <sup>2</sup>	<input type="checkbox"/> = D

## Finger Protection and Hand Protection only

Type	<b>5</b>
-	Blank
Flexible Height Model <Protective heights available in increments of 40 mm>	<input type="checkbox"/> = F

\*1. Representative models are listed. For other models, refer to page 34 and following.

\*2. Emitters and receivers will be available separately soon.

**PG**

Complete the model number.

**F3SG-4PGA**  -  -   
② ① ③

① Select an application and then select a beam gap and number of beams.

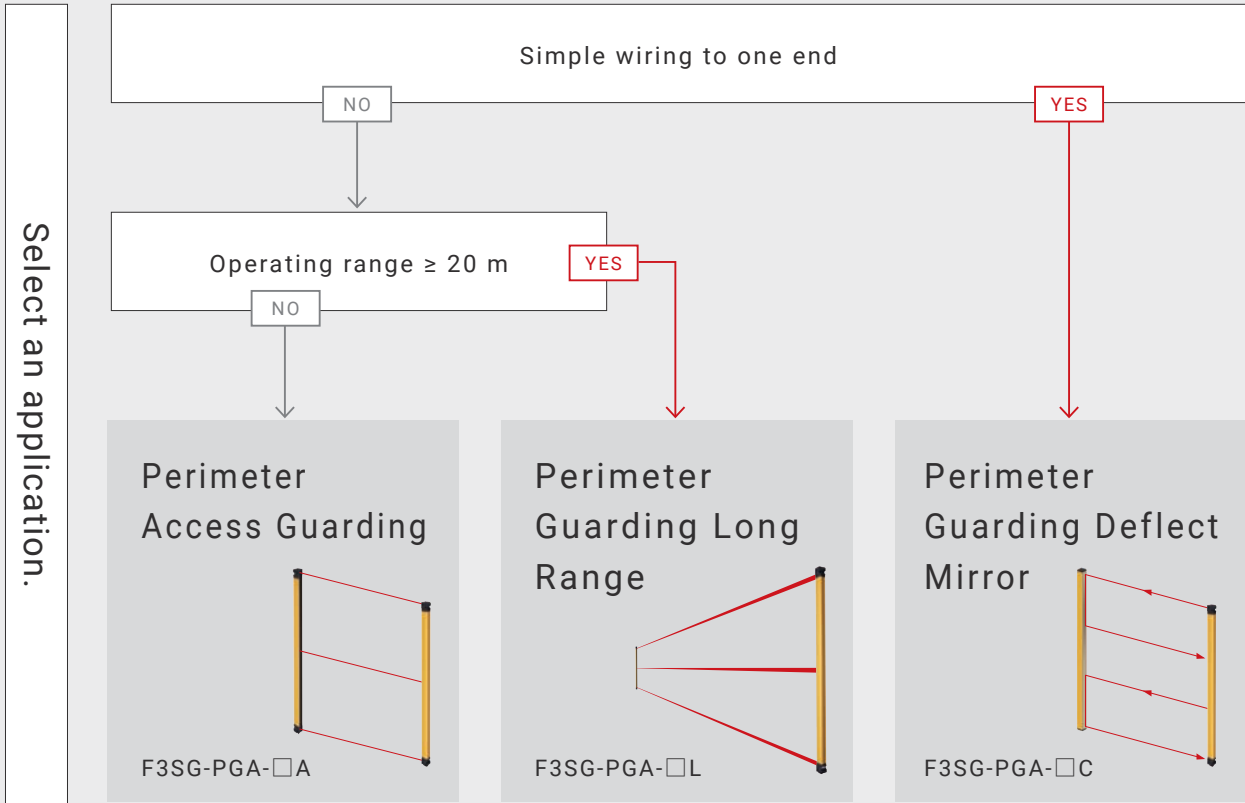

Select a beam gap and number of beams.

Beam gap/ number of beams	①	Beam gap/ number of beams	①	Beam gap/ number of beams	①
500 mm/2 beams	□□=2A	500 mm/2 beams	□□=2L	500 mm/2 beams	□□=2C
400 mm/3 beams	□□=3A	400 mm/3 beams	□□=3L	400 mm/3 beams	□□=3C
300 or 400 mm/ 4 beams	□□=4A	300 or 400 mm/ 4 beams	□□=4L	300 or 400 mm/ 4 beams	□□=4C

**2** Select protective height.\*<sup>1</sup>

Protective height (mm)	Number of beams	<b>2</b>
670	2	<input type="checkbox"/> <input type="checkbox"/> <input type="checkbox"/> <input type="checkbox"/> =0670
970	3	<input type="checkbox"/> <input type="checkbox"/> <input type="checkbox"/> <input type="checkbox"/> =0970
1070	4	<input type="checkbox"/> <input type="checkbox"/> <input type="checkbox"/> <input type="checkbox"/> =1070
1370	4	<input type="checkbox"/> <input type="checkbox"/> <input type="checkbox"/> <input type="checkbox"/> =1370

**3** Select an option.

Type	<b>3</b>
Set of emitter and receiver, or set of emitter/receiver and passive mirror	Blank
Emitter <sup>*2</sup>	<input type="checkbox"/> =L
Receiver <sup>*2</sup>	<input type="checkbox"/> =D
Emitter/receiver <sup>*2</sup> (Perimeter Guarding Deflect Mirror only)	<input type="checkbox"/> =LD
Passive mirror <sup>*2</sup> (Perimeter Guarding Deflect Mirror only)	<input type="checkbox"/> =M

\*1. Representative models are listed. For other models, refer to page 36 and following.

\*2. Emitters, receivers, emitter/receivers, and passive mirrors will be available separately soon.

## STEP 2 Choose a mounting bracket

See page 37 for details of mounting brackets.

Side-Mount Bracket  
(Intermediate Bracket)



Standard accessory

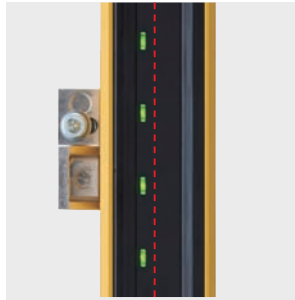

Suitable for mounting on an aluminum profile so that its center is aligned with the center of beams.

- Included as a standard accessory with the light curtain
- Side mounting and backside mounting
- Beams not adjustable after installation

[Number of provided brackets]

Protective height ≤ 1,440 mm : 4

Protective height ≤ 1,520 mm : 6

## Brackets that allow beam adjustment after the light curtain is installed

Adjustable Side-Mount Bracket  
(Intermediate Bracket)  
F39-LSGA



- Vertical adjustment  
Angle adjustment range :  $\pm 15^\circ$
- Side mounting and backside mounting
- Two brackets per set

Adjustable Top/  
Bottom Bracket  
F3SJ, F3SN Adapter  
F39-LSGTB-SJ



- Used at the top and bottom of the light curtain
- Angle adjustment range :  $\pm 22.5^\circ$
- For replacement of F3SJ or F3SN Series
- Side mounting and backside mounting
- Two brackets per set

Mounting brackets to easily replace your existing Omron light curtains are also available.

For replacement of F3SG-RA/RE Series

Adjustable Top/Bottom Bracket  
F3SG-RA/RE Adapter  
F39-LSGTB-RE



For replacement of MS4800 Series and F3SR-B Series

Adjustable Top/Bottom Bracket  
MS4800/F3SR Adapter  
F39-LSGTB-MS



## STEP 3 Choose a wiring method

See page 38 and following for details of cables.

### One light curtain

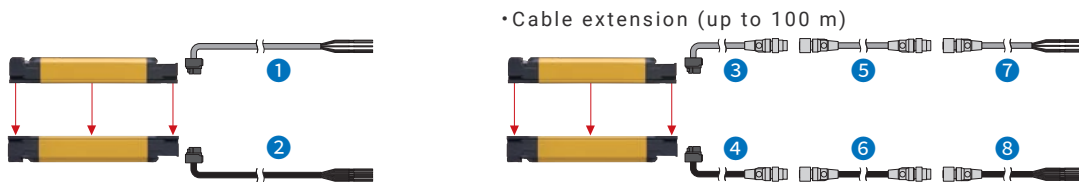

### Series-connected

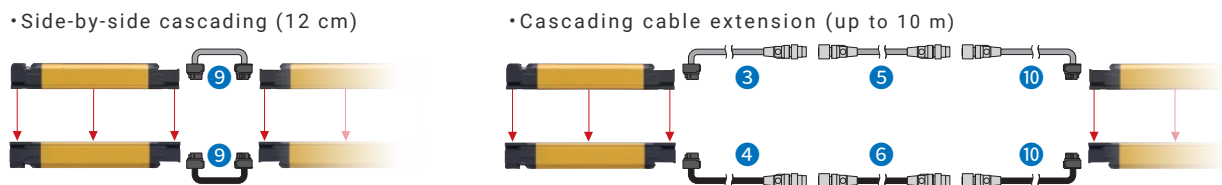

### Use of reduced wiring connector

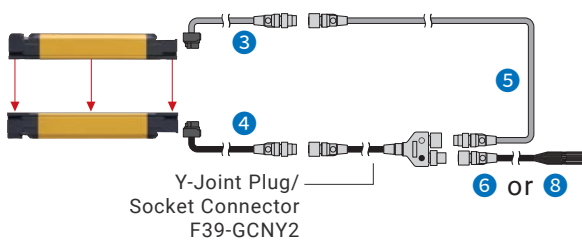

### Use of Intelligent Tap

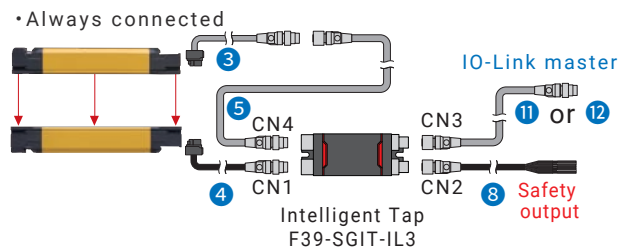

### Replacement of Omron light curtain

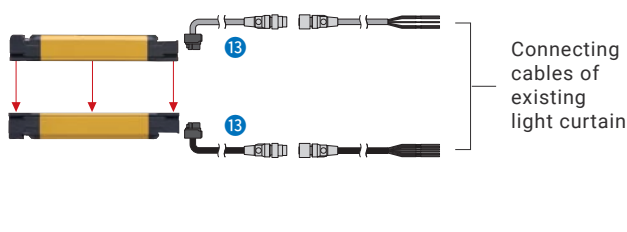

### • Connected for setting (optical synchronization)

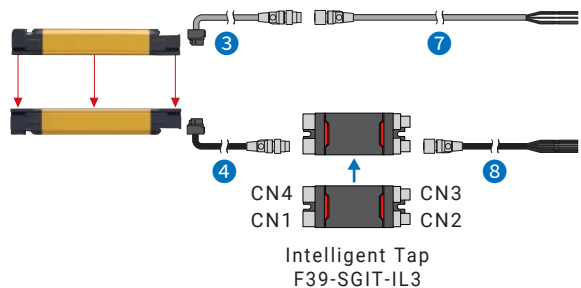

No.	Product name	Appearance	Model	Cable length	Remarks
1	Root-Straight Cable		F39-JG□C-L	3, 7, 10 m	For emitter, gray
2			F39-JG□C-D	3, 7, 10 m	For receiver, black
3	Root-Plug Cable for Extended		F39-JGR3K-L	30 cm	For emitter, gray
4			F39-JGR3K-D	30 cm	For receiver, black
5	Extended Plug-Socket Cable		F39-JG□B-L	3, 10, 20 m	For emitter, gray
6			F39-JG□B-D	3, 10, 20 m	For receiver, black
7	Extended Socket-Straight Cable		F39-JG□A-L	3, 10 m	For emitter, gray
8			F39-JG□A-D	3, 10 m	For receiver, black
9	Side-by-side Cascading Cable		F39-JGR12L	12 cm	For emitter and receiver, two cables per set
10	Cascading Cable for Extended		F39-JGR3W	30 cm	For emitter and receiver, two cables per set
11	Socket-Straight Cable for IO-Link		F39-JG□B-L	3, 10, 20 m	For connection to GX-ILM08C
12	Root-Straight Cable for IO-Link		XS5F-D521-DJ0-IL	2 m	For connection to NX-ILM400
13	Conversion Cable		F39-JGR3K-SJ	30 cm	For use of wiring for F3SN, F3SJ-A/-B, or F3SR
			F39-JGR3K-RE	30 cm	For use of wiring for F3SG-RE
			F39-JGR3K-MS	30 cm	For use of wiring for MS4800

STEP 4 Choose the accessories you need

\* See page 42 and following for details of accessories.

## Intelligent Tap and configuration tool SD Manager 3

Easy monitoring, setting, and IO-Link connection with external devices

Page 42

Intelligent Tap  
F39-SGIT-IL3



Configuration tool  
for PC

SD Manager 3

Note : Use the SD Manager 3 with the F39-SGIT-IL3 Intelligent Tap.



Bluetooth  
Communication Unit  
F39-SGBT



Monitoring tool for  
smartphones and tablets  
SD Manager 3 Mobile APP

Requirements  
Android 7.0 or higher

For details, refer to your local Omron website.



## Reduced wiring system

Simple wiring of light curtains and reset switches

Page 43

Y-Joint Plug/Socket Connector  
F39-GCNY2

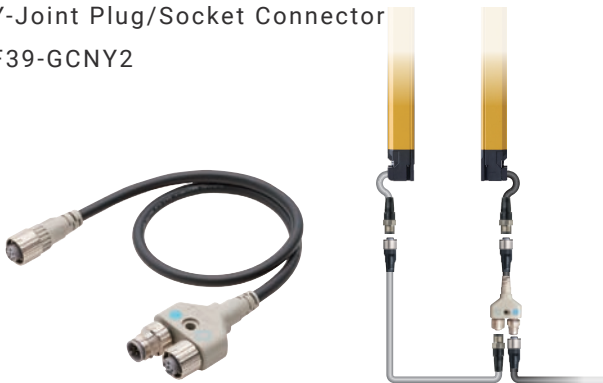

Reset Switch Connector  
F39-GCNY3

Note : Please prepare a reset switch (NC contact).

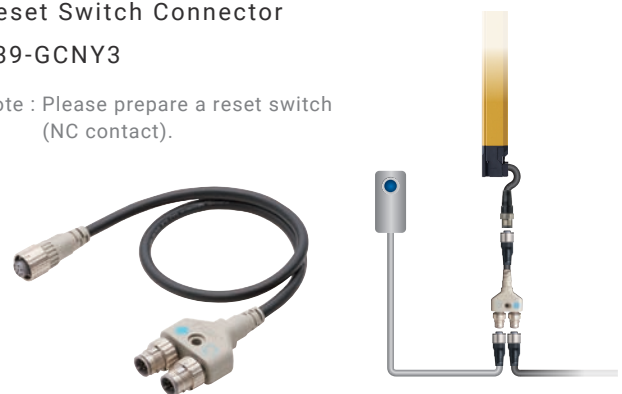

## Muting system

Easy installation and wiring of muting sensors

Page 44

Muting Sensor Arm Mounter

F39-FMA□□□T

(Through-beam) Scheduled for release

F39-FMA□□□R

(Retro-reflective) Scheduled for release



Muting Sensor Connection Box

F39-GCN5 Scheduled for release

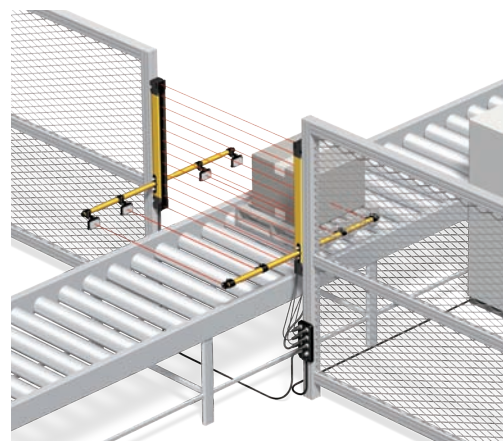

## Floor mount system

Easy installation of light curtains and mirrors on floors

Page 46

Floor Mount Column

F39-ST Scheduled for release

Mount-Column Adjustable Base

F39-STB Scheduled for release

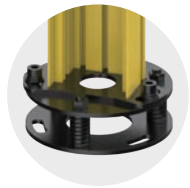

Mirror Column  
(for F3SG-SR  
Safety Light Curtain)

F39-SML Scheduled for release

Mirror Column  
(for F3SG-PG  
Safety Multi-Light Beam)

F39-PML Scheduled for release



## Laser Alignment Pointer

Easy beam adjustment with laser beam Page 47

F39-PTG



## Lamp

At-a-glance check of light curtain status Page 47

F39-SGLP Scheduled for release

Note: The Lamp does not support Bluetooth communication.



## Spatter Protection Cover

Protection of optical surfaces  
against spatter

Page 48

F39-HSG



- STI is a trademark or registered trademark of OMRON Corporation in Japan and other countries.
- The Bluetooth® word mark and logo are registered trademarks and are owned by the Bluetooth SIG, Inc. and any use of such mark by OMRON Corporation is under license.
- Microsoft product screen shot(s) reprinted with permission from Microsoft Corporation.
- Some images are used under license from Shutterstock.com.
- USB Type-C™ is a trademark of USB Implementers Forum.
- Windows® is a registered trademark of Microsoft Corporation in the USA and other countries.
- Android™ is a trademark of Google LLC.
- The product photographs and figures that are used in this catalog may vary somewhat from the actual products.
- Other company names and product names in this document are the trademarks or registered trademarks of their respective companies.

# Safety Light Curtain/Safety Multi-Light Beam F3SG-SR/PG

## The best ever light curtain

- Conforms to major international standards
- Environmental resistance and rugged structure for use in any environment (IP67, IP67G \*1)
- Industry's broadest line-up \*2, from finger protection to body protection
- Flexible height model for easy integration into machines and lines
- For diverse applications, from simple protection to data utilization

\*1. IEC 60529/JIS C 0920 Annex 1

\*2. Based on Omron investigation in June 2018.



For the most recent information on models that have been certified for safety standards, refer to your local OMRON website.

## Table of Contents

Model Number Legend .....	page 33
Ordering Information .....	page 34
Ratings and Specifications .....	page 49
List of Models/Response Time/Current Consumption/Weight .....	page 55
Legislation and Standards .....	page 62
Indicator .....	page 63
Connections (Basic Wiring Diagram).....	page 66
Connectable Safety Control Units .....	page 75
Input/Output Circuit .....	page 76
Dimensions .....	page 78
Troubleshooting.....	page 95
Related Manuals .....	page 104

## Model Number Legend

### Safety Light Curtain F3SG-SR

F3SG-4SR □ □ □ □ □ - □ □ - □ - □  
 (1) (2) (3) (4) (5) (6)

No.	Classification	Code	Meaning	Remarks
(1)	Type of ESPE	4	Type 4	
(2)	Function	A	Advanced	
		B	Standard	
(3)	Protective height	0160 - 2000	Protective height for finger protection (mm)	
		0160 - 2480	Protective height for hand protection (mm)	
		0240 - 1520	Protective height for arm/leg protection (mm)	
		0280 - 0920	Protective height for body protection (mm)	
(4)	Detection capability	14	Finger protection (Detection capability: 14-mm dia.)	
		25	Hand protection (Detection capability: 25-mm dia.)	
		45	Arm/leg protection (Detection capability: 45-mm dia.)	
		85	Body protection (Detection capability: 85-mm dia.)	
(5)	Option 1	Blank	Set of emitter and receiver	
		L	Emitter	
		D	Receiver	
(6)	Option 2	Blank		
		F	Flexible height model	Finger protection and hand protection: Protective heights are available in increments of 40 mm up to 1 m

- Note:** 1. The purpose of this model number legend is to provide understanding of the meaning of specifications from the model number. Models are not available for all combinations of code numbers. See *Ordering Information* on page 34 for details.
2. The side-mount brackets (intermediate brackets) are included with the safety light curtain.
3. Connection cables are not included with the safety light curtain. Order cables sold separately.

### Safety Multi-Light Beam F3SG-PG Scheduled for release

F3SG-4PG A □ □ □ □ □ - □ □ - □ - □  
 (1) (2) (3) (4) (5) (6) (7)

No.	Classification	Code	Meaning	Remarks
(1)	Type of ESPE	4	Type 4	
(2)	Function	A	Advanced	
(3)	Protective height	0670	Protective height (mm)	
		0970		
		1070		
		1370		
(4)	Number of beams/ beam gap	2	2 beams/500 mm	Protective height: 670 mm
		3	3 beams/400 mm	Protective height: 970 mm
		4	4 beams/300 or 400 mm	Protective height: 1,070 or 1,370 mm
(5)	Application	A	Perimeter access guarding	
		L	Perimeter guarding long range	
		C	Perimeter guarding deflect mirror	
(6)	Option 1	Blank	Set of emitter and receiver or set of emitter/receiver and passive mirror	
		L	Emitter	
		D	Receiver	
		LD	Emitter/receiver	Perimeter guarding deflect mirror only
		M	Passive mirror	Perimeter guarding deflect mirror only
(7)	Option 2	Blank		

- Note:** 1. The purpose of this model number legend is to provide understanding of the meaning of specifications from the model number. Models are not available for all combinations of code numbers. See *Ordering Information* on page 36 for details.
2. The side-mount brackets (intermediate brackets) are included with the safety multi-light beam.
3. Connection cables are not included with the safety multi-light beam. Order cables sold separately.

# F3SG-SR/PG

## Ordering Information

### Main Units

#### Safety Light Curtain

\* Emitters and receivers will be available separately soon.

Example 1) Emitter: F3SG-4SRA0160-14-L, receiver: F3SG-4SRA0160-14-D

Example 2) Receiver (flexible height model) only: F3SG-4SRA0200-14-D-F

#### Finger protection (Detection capability: 14-mm dia.)

Number of beams	Protective height (mm)	Advanced	Standard
		Model	Model
15	160	F3SG-4SRA0160-14	F3SG-4SRB0160-14
19	200	F3SG-4SRA0200-14-F	F3SG-4SRB0200-14-F
23	240	F3SG-4SRA0240-14	F3SG-4SRB0240-14
27	280	F3SG-4SRA0280-14-F	F3SG-4SRB0280-14-F
31	320	F3SG-4SRA0320-14	F3SG-4SRB0320-14
35	360	F3SG-4SRA0360-14-F	F3SG-4SRB0360-14-F
39	400	F3SG-4SRA0400-14	F3SG-4SRB0400-14
43	440	F3SG-4SRA0440-14-F	F3SG-4SRB0440-14-F
47	480	F3SG-4SRA0480-14	F3SG-4SRB0480-14
51	520	F3SG-4SRA0520-14-F	F3SG-4SRB0520-14-F
55	560	F3SG-4SRA0560-14	F3SG-4SRB0560-14
59	600	F3SG-4SRA0600-14-F	F3SG-4SRB0600-14-F
63	640	F3SG-4SRA0640-14	F3SG-4SRB0640-14
67	680	F3SG-4SRA0680-14-F	F3SG-4SRB0680-14-F
71	720	F3SG-4SRA0720-14-F	F3SG-4SRB0720-14-F
75	760	F3SG-4SRA0760-14-F	F3SG-4SRB0760-14-F
79	800	F3SG-4SRA0800-14	F3SG-4SRB0800-14
83	840	F3SG-4SRA0840-14-F	F3SG-4SRB0840-14-F
87	880	F3SG-4SRA0880-14-F	F3SG-4SRB0880-14-F
91	920	F3SG-4SRA0920-14-F	F3SG-4SRB0920-14-F
95	960	F3SG-4SRA0960-14-F	F3SG-4SRB0960-14-F
99	1,000	F3SG-4SRA1000-14	F3SG-4SRB1000-14
119	1,200	F3SG-4SRA1200-14	F3SG-4SRB1200-14
139	1,400	F3SG-4SRA1400-14	F3SG-4SRB1400-14
159	1,600	F3SG-4SRA1600-14	F3SG-4SRB1600-14
179	1,800	F3SG-4SRA1800-14	F3SG-4SRB1800-14
199	2,000	F3SG-4SRA2000-14	F3SG-4SRB2000-14

Hand protection (Detection capability: 25-mm dia.)

Number of beams	Protective height (mm)	Advanced	Standard
		Model	Model
8	160	F3SG-4SRA0160-25	F3SG-4SRB0160-25
10	200	F3SG-4SRA0200-25-F	F3SG-4SRB0200-25-F
12	240	F3SG-4SRA0240-25	F3SG-4SRB0240-25
14	280	F3SG-4SRA0280-25-F	F3SG-4SRB0280-25-F
16	320	F3SG-4SRA0320-25	F3SG-4SRB0320-25
18	360	F3SG-4SRA0360-25-F	F3SG-4SRB0360-25-F
20	400	F3SG-4SRA0400-25	F3SG-4SRB0400-25
22	440	F3SG-4SRA0440-25-F	F3SG-4SRB0440-25-F
24	480	F3SG-4SRA0480-25	F3SG-4SRB0480-25
26	520	F3SG-4SRA0520-25-F	F3SG-4SRB0520-25-F
28	560	F3SG-4SRA0560-25	F3SG-4SRB0560-25
30	600	F3SG-4SRA0600-25-F	F3SG-4SRB0600-25-F
32	640	F3SG-4SRA0640-25	F3SG-4SRB0640-25
34	680	F3SG-4SRA0680-25-F	F3SG-4SRB0680-25-F
36	720	F3SG-4SRA0720-25	F3SG-4SRB0720-25
38	760	F3SG-4SRA0760-25-F	F3SG-4SRB0760-25-F
40	800	F3SG-4SRA0800-25	F3SG-4SRB0800-25
42	840	F3SG-4SRA0840-25-F	F3SG-4SRB0840-25-F
44	880	F3SG-4SRA0880-25	F3SG-4SRB0880-25
46	920	F3SG-4SRA0920-25-F	F3SG-4SRB0920-25-F
48	960	F3SG-4SRA0960-25	F3SG-4SRB0960-25
50	1,000	F3SG-4SRA1000-25-F	F3SG-4SRB1000-25-F
52	1,040	F3SG-4SRA1040-25	F3SG-4SRB1040-25
56	1,120	F3SG-4SRA1120-25	F3SG-4SRB1120-25
60	1,200	F3SG-4SRA1200-25	F3SG-4SRB1200-25
64	1,280	F3SG-4SRA1280-25	F3SG-4SRB1280-25
68	1,360	F3SG-4SRA1360-25	F3SG-4SRB1360-25
72	1,440	F3SG-4SRA1440-25	F3SG-4SRB1440-25
76	1,520	F3SG-4SRA1520-25	F3SG-4SRB1520-25
80	1,600	F3SG-4SRA1600-25	F3SG-4SRB1600-25
84	1,680	F3SG-4SRA1680-25	F3SG-4SRB1680-25
88	1,760	F3SG-4SRA1760-25	F3SG-4SRB1760-25
92	1,840	F3SG-4SRA1840-25	F3SG-4SRB1840-25
96	1,920	F3SG-4SRA1920-25	F3SG-4SRB1920-25
104	2,080	F3SG-4SRA2080-25	F3SG-4SRB2080-25
114	2,280	F3SG-4SRA2280-25	F3SG-4SRB2280-25
124	2,480	F3SG-4SRA2480-25	F3SG-4SRB2480-25

# F3SG-SR/PG

## Arm/Leg protection (Detection capability: 45-mm dia.)

Number of beams	Protective height (mm)	Advanced	Standard
		Model	Model
6	240	F3SG-4SRA0240-45	F3SG-4SRB0240-45
10	400	F3SG-4SRA0400-45	F3SG-4SRB0400-45
14	560	F3SG-4SRA0560-45	F3SG-4SRB0560-45
18	720	F3SG-4SRA0720-45	F3SG-4SRB0720-45
22	880	F3SG-4SRA0880-45	F3SG-4SRB0880-45
30	1,200	F3SG-4SRA1200-45	F3SG-4SRB1200-45
38	1,520	F3SG-4SRA1520-45	F3SG-4SRB1520-45

## Body (Detection capability: 85-mm dia.)

Number of beams	Protective height (mm)	Advanced	Standard
		Model	Model
4	280	F3SG-4SRA0280-85	F3SG-4SRB0280-85
6	440	F3SG-4SRA0440-85	F3SG-4SRB0440-85
8	600	F3SG-4SRA0600-85	F3SG-4SRB0600-85
10	760	F3SG-4SRA0760-85	F3SG-4SRB0760-85
12	920	F3SG-4SRA0920-85	F3SG-4SRB0920-85

## Safety Multi-Light Beam Scheduled for release

\* Emitters and receivers will be available separately soon.

Example 1) Emitter: F3SG-4PGA0670-2A-L, receiver: F3SG-4PGA0670-2A-D

Example 2) Emitter/receiver: F3SG-4PGA0970-3C-LD, passive mirror: F3SG-4PGA0970-3C-M

## Perimeter access guarding (Beam gap: 300 to 500 mm)

Number of beams	Protective height (mm)	Advanced
		Model
2	670	F3SG-4PGA0670-2A
3	970	F3SG-4PGA0970-3A
4	1,070	F3SG-4PGA1070-4A
4	1,370	F3SG-4PGA1370-4A

## Perimeter guarding long range (Beam gap: 300 to 500 mm)

Number of beams	Protective height (mm)	Advanced
		Model
2	670	F3SG-4PGA0670-2L
3	970	F3SG-4PGA0970-3L
4	1,070	F3SG-4PGA1070-4L
4	1,370	F3SG-4PGA1370-4L

## Perimeter guarding deflect mirror (Beam gap: 300 to 500 mm)

Number of beams	Protective height (mm)	Advanced
		Model
2	670	F3SG-4PGA0670-2C
3	970	F3SG-4PGA0970-3C
4	1,070	F3SG-4PGA1070-4C
4	1,370	F3SG-4PGA1370-4C

## Accessories (Sold separately)

### Safety Light Curtain/Safety Multi-Light Beam Mounting Bracket





The side-mount brackets (intermediate brackets) are included with the light curtain.

Order the brackets listed below when angle adjustment is required.

#### For F3SG-SR/PG

The bracket allows beam adjustment after the F3SG-SR/PG is mounted on it.

Side mounting and backside mounting are possible.

Appearance	Type	Application	Model
	Adjustable Side-Mount Bracket (Intermediate Bracket)	The angle adjustment range is $\pm 15^\circ$ . Two brackets per set (See *1 below for the number of sets required for each model.)	F39-LSGA
	Adjustable Top/Bottom Bracket F3SJ, F3SN Adapter	Use this bracket at the top and bottom positions of the F3SG-SR/PG. The angle adjustment range is $\pm 22.5^\circ$ . Use this bracket when replacing an existing F3SJ or F3SN Safety Light Curtain. Two brackets per set (See *2 below for the number of sets required for each model.)	F39-LSGTB-SJ
	Adjustable Top/Bottom Bracket F3SG-RA/RE Adapter	Use this bracket at the top and bottom positions of the F3SG-SR/PG. The angle adjustment range is $\pm 22.5^\circ$ . Use this bracket when replacing an existing F3SG-RA/RE Safety Light Curtain. Two brackets per set (See *2 below for the number of sets required for each model.)	F39-LSGTB-RE
	Adjustable Top/Bottom Bracket MS4800, F3SR Adapter	Use this bracket at the top and bottom positions of the F3SG-SR/PG. The angle adjustment range is $\pm 22.5^\circ$ . Use this bracket when replacing an existing MS4800 or F3SR Safety Light Curtain. Two brackets per set (See *2 below for the number of sets required for each model.)	F39-LSGTB-MS

\*1. Protective height of 0160 to 0280: 1 sets (2 brackets), protective height of 0320 to 1440: 2 sets (4 brackets), protective height of 1520 to 2480: 3 sets (6 brackets)

\*2. Using Adjustable Top/Bottom Brackets with Side-Mount Brackets (Intermediate Brackets) or Adjustable Side-Mount Brackets (Intermediate Brackets)

Protective height of 0840 or less:

The Side-Mount Bracket (Intermediate Bracket) or Adjustable Side-Mount Bracket (Intermediate Bracket) is not required. Use 2 sets of Adjustable Top/Bottom Brackets.

Protective height of 0880 to 1680:

Use 2 sets of Adjustable Top/Bottom Brackets and 1 set of Side-Mount Brackets (Intermediate Brackets) or Adjustable Side-Mount Brackets (Intermediate Brackets).

Protective height of 1760 to 2480:

Use 2 sets of Adjustable Top/Bottom Brackets and 2 sets of Side-Mount Brackets (Intermediate Brackets) or Adjustable Side-Mount Brackets (Intermediate Brackets).



Refer to *Dimensions* on page 78 and following.

## Safety Light Curtain/Safety Multi-Light Beam Connecting Cable Root-Straight Cable

Appearance	Type	Cable length	Specifications	Model															
	For emitter To sensors: dedicated connector, To external: open-ended type 5 wires Color: Gray	3 m	<table border="1"> <tr><td>Brown</td><td>24V/0V</td></tr> <tr><td>Black</td><td>TEST</td></tr> <tr><td>Blue</td><td>0V/24V</td></tr> <tr><td>White</td><td>COM(+)</td></tr> <tr><td>Yellow</td><td>OPERATING RANGE SELECT INPUT/COM(-)</td></tr> </table>	Brown	24V/0V	Black	TEST	Blue	0V/24V	White	COM(+)	Yellow	OPERATING RANGE SELECT INPUT/COM(-)	F39-JG3C-L					
		Brown	24V/0V																
		Black	TEST																
	Blue	0V/24V																	
	White	COM(+)																	
	Yellow	OPERATING RANGE SELECT INPUT/COM(-)																	
7 m		F39-JG7C-L																	
10 m		F39-JG10C-L																	
For receiver or emitter/receiver of F3SG-PG Perimeter Guarding Deflect Mirror To sensors: dedicated connector, To external: open-ended type 8 wires Color: Black	3 m	<table border="1"> <tr><td>Yellow</td><td>RESET/EDM</td></tr> <tr><td>Brown</td><td>24V/0V</td></tr> <tr><td>Gray</td><td>MUTE A/PRE-RESET/PSDI/COM(+)</td></tr> <tr><td>Pink</td><td>MUTE B/COM(-)</td></tr> <tr><td>Black</td><td>OSSD 1</td></tr> <tr><td>White</td><td>OSSD 2</td></tr> <tr><td>Blue</td><td>0V/24V</td></tr> <tr><td>Red</td><td>AUX</td></tr> </table>	Yellow	RESET/EDM	Brown	24V/0V	Gray	MUTE A/PRE-RESET/PSDI/COM(+)	Pink	MUTE B/COM(-)	Black	OSSD 1	White	OSSD 2	Blue	0V/24V	Red	AUX	F39-JG3C-D
	Yellow	RESET/EDM																	
	Brown	24V/0V																	
Gray	MUTE A/PRE-RESET/PSDI/COM(+)																		
Pink	MUTE B/COM(-)																		
Black	OSSD 1																		
White	OSSD 2																		
Blue	0V/24V																		
Red	AUX																		
7 m		F39-JG7C-D																	
10 m		F39-JG10C-D																	



**Note:** Cables are not included with the safety light curtain/safety multi-light beam.  
Order the F39-JG□C-□ Root-Straight Cable or F39-JGR3K-L/-D Root-Plug Cable for Extended.

## Root-Plug Cable for Extended

Appearance	Type	Cable length	Specifications	Model																								
	For emitter To sensors: dedicated connector, To external: M12 connector type (5-pin) Color: Gray	0.3 m	<table border="1"> <tr><td>1</td><td>Brown</td><td>24V/0V</td></tr> <tr><td>2</td><td>Black</td><td>TEST</td></tr> <tr><td>3</td><td>Blue</td><td>0V/24V</td></tr> <tr><td>4</td><td>White</td><td>COM(+)</td></tr> <tr><td>5</td><td>Yellow</td><td>OPERATING RANGE SELECT INPUT/COM(-)</td></tr> </table>	1	Brown	24V/0V	2	Black	TEST	3	Blue	0V/24V	4	White	COM(+)	5	Yellow	OPERATING RANGE SELECT INPUT/COM(-)	 <p>Male</p>	F39-JGR3K-L								
			1	Brown	24V/0V																							
2	Black	TEST																										
3	Blue	0V/24V																										
4	White	COM(+)																										
5	Yellow	OPERATING RANGE SELECT INPUT/COM(-)																										
For receiver or emitter/receiver of F3SG-PG Perimeter Guarding Deflect Mirror To sensors: dedicated connector, To external: M12 connector type (8-pin) Color: Black	0.3 m	<table border="1"> <tr><td>1</td><td>Yellow</td><td>RESET/EDM</td></tr> <tr><td>2</td><td>Brown</td><td>24V/0V</td></tr> <tr><td>3</td><td>Gray</td><td>MUTE A/PRE-RESET/PSDI/COM(+)</td></tr> <tr><td>4</td><td>Pink</td><td>MUTE B/COM(-)</td></tr> <tr><td>5</td><td>Black</td><td>OSSD 1</td></tr> <tr><td>6</td><td>White</td><td>OSSD 2</td></tr> <tr><td>7</td><td>Blue</td><td>0V/24V</td></tr> <tr><td>8</td><td>Red</td><td>AUX</td></tr> </table>	1	Yellow	RESET/EDM	2	Brown	24V/0V	3	Gray	MUTE A/PRE-RESET/PSDI/COM(+)	4	Pink	MUTE B/COM(-)	5	Black	OSSD 1	6	White	OSSD 2	7	Blue	0V/24V	8	Red	AUX	 <p>Male</p>	F39-JGR3K-D
		1	Yellow	RESET/EDM																								
2	Brown	24V/0V																										
3	Gray	MUTE A/PRE-RESET/PSDI/COM(+)																										
4	Pink	MUTE B/COM(-)																										
5	Black	OSSD 1																										
6	White	OSSD 2																										
7	Blue	0V/24V																										
8	Red	AUX																										

**Note:** 1. Cables are not included with the safety light curtain/safety multi-light beam.  
Order the F39-JG□C-□ Root-Straight Cable or F39-JGR3K-L/-D Root-Plug Cable for Extended.  
2. Use with the F39-JG□A-□ Extended Socket-Straight Cable or F39-JG□B-□ Extended Plug-Socket Cable.

**Extended Socket-Straight Cable**

Appearance	Type	Cable length	Specifications	Model																								
	For emitter M12 connector (5-pin), 5 wires Color: Gray	3 m	Connected to root cable or Extended Plug-Socket Cable  Female IP67* rated when mated.	<table border="1"> <tr><td>1</td><td>Brown</td><td>24V/0V</td></tr> <tr><td>2</td><td>Black</td><td>TEST</td></tr> <tr><td>3</td><td>Blue</td><td>0V/24V</td></tr> <tr><td>4</td><td>White</td><td>COM(+)</td></tr> <tr><td>5</td><td>Yellow</td><td>OPERATING RANGE SELECT INPUT/COM(-)</td></tr> </table>	1	Brown	24V/0V	2	Black	TEST	3	Blue	0V/24V	4	White	COM(+)	5	Yellow	OPERATING RANGE SELECT INPUT/COM(-)	F39-JG3A-L								
		1			Brown	24V/0V																						
	2	Black	TEST																									
	3	Blue	0V/24V																									
4	White	COM(+)																										
5	Yellow	OPERATING RANGE SELECT INPUT/COM(-)																										
10 m	F39-JG10A-L																											
For receiver or emitter/receiver of F3SG-PG Perimeter Guarding Deflect Mirror M12 connector (8-pin), 8 wires Color: Black	3 m	Connected to root cable or Extended Plug-Socket Cable  Female IP67* rated when mated.	<table border="1"> <tr><td>1</td><td>Yellow</td><td>RESET/EDM</td></tr> <tr><td>2</td><td>Brown</td><td>24V/0V</td></tr> <tr><td>3</td><td>Gray</td><td>MUTE A/PRE-RESET/PSDI/COM(+)</td></tr> <tr><td>4</td><td>Pink</td><td>MUTE B/COM(-)</td></tr> <tr><td>5</td><td>Black</td><td>OSSD 1</td></tr> <tr><td>6</td><td>White</td><td>OSSD 2</td></tr> <tr><td>7</td><td>Blue</td><td>0V/24V</td></tr> <tr><td>8</td><td>Red</td><td>AUX</td></tr> </table>	1	Yellow	RESET/EDM	2	Brown	24V/0V	3	Gray	MUTE A/PRE-RESET/PSDI/COM(+)	4	Pink	MUTE B/COM(-)	5	Black	OSSD 1	6	White	OSSD 2	7	Blue	0V/24V	8	Red	AUX	F39-JG3A-D
	1			Yellow	RESET/EDM																							
2	Brown	24V/0V																										
3	Gray	MUTE A/PRE-RESET/PSDI/COM(+)																										
4	Pink	MUTE B/COM(-)																										
5	Black	OSSD 1																										
6	White	OSSD 2																										
7	Blue	0V/24V																										
8	Red	AUX																										
10 m	F39-JG10A-D																											





\* When the accessory is used, protect it from cutting oil.

**Note:** 1. Use with the F39-JGR3K-L/-D Root-Plug Cable for Extended.

2. To extend the cable length to more than 10 m, connect the F39-JG□B-□ Extended Plug-Socket Cable to the F39-JG□A-□ Extended Socket-Straight Cable.

3. Also available in 7, 15 and 20 m. For detail, contact your Omron representative.

**Extended Plug-Socket Cable**

Appearance	Type	Cable length	Specifications	Model
	For emitter M12 connector (5-pin) on both ends Color: Gray	3 m	Connected to Root-Plug Cable for Extended or Extended Plug-Socket Cable Connected to Extended Socket-Straight Cable or Extended Plug-Socket Cable  Female  Male Twisted pair wires are brown and blue, and white and yellow. IP67* rated when mated.	F39-JG3B-L
		10 m		F39-JG10B-L
		20 m		F39-JG20B-L
	For receiver or emitter/receiver of F3SG-PG Perimeter Guarding Deflect Mirror M12 connector (8-pin) on both ends Color: Black	3 m	Connected to Root-Plug Cable for Extended or Extended Plug-Socket Cable Connected to Extended Socket-Straight Cable or Extended Plug-Socket Cable  Female  Male Twisted pair wires are brown and blue, black and white, yellow and red, and gray and pink. IP67* rated when mated.	F39-JG3B-D
		10 m		F39-JG10B-D
		20 m		F39-JG20B-D

\* When the accessory is used, protect it from cutting oil.

**Note:** 1. Use with the F39-JGR3K-L/-D Root-Plug Cable for Extended.

2. To extend the cable length to more than 30 m, connect two or more F39-JG□B-□ Extended Plug-Socket Cable to the F39-JG□A-□ Extended Socket-Straight Cable.

Example: To extend the cable length to 50 m, connect two F39-JG20B-□ (20 m) Extended Plug-Socket Cables and one F39-JG10A-□ (10 m) Extended Socket-Straight Cable.

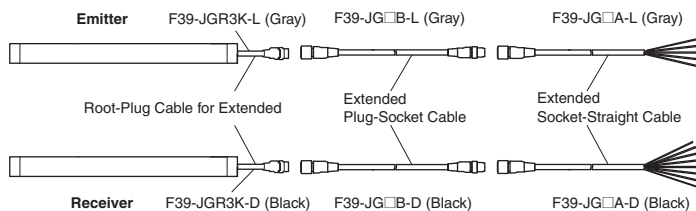

3. Also available in 0.5, 1, 5, 7 and 15 m. For detail, contact your Omron representative.

## Side-by-side Cascading Cable (Two cables per set, one for emitter and one for receiver)

Appearance	Type	Cable length	Specifications	Model
	For emitter To sensors: dedicated connector 1, To cascading sensors: dedicated connector 2 Color: Gray For receiver To sensors: dedicated connector 1, To cascading sensors: dedicated connector 2 Color: Black	12 cm	Used to series-connect sensors with the minimum cable length of 12 cm. IP67 and IP67G (JIS C 0920 Annex 1) rated when mated.	<b>F39-JGR12L</b>

**Note:** To extend the cable length between the series-connected sensors to more than 12 cm, add the F39-JGR3W Cascading Cable for Extended.

## Cascading Cable for Extended (Two cables per set, one for emitter and one for receiver)

Appearance	Type	Cable length	Specifications	Model
	For emitter To sensors: dedicated connector, To cascading sensors: M12 connector type (5 pin) Color: Gray For receiver To sensors: dedicated connector, To cascading sensors: M12 connector type (8 pin) Color: Black	0.3 m	Used together with the F39-JGR3K Root-Plug Cable for Extended to extend the cable length between the series-connected sensors to more than 12 cm. IP67 and IP67G (JIS C 0920 Annex 1) rated when mated.	<b>F39-JGR3W</b>

**Note:** To extend the cable length between the series-connected sensors to more than 60 cm, connect the F39-JG□B-□ Extended Plug-Socket Cable (up to 10 m: F39-JG10B-□) to the F39-JGR3W Cascading Cable for Extended. Extension cable between sensors: 10 m max. (not including Cascading Cable for Extended (F39-JGR3W) and Root Cable (F39-JGR3K-L-D).)

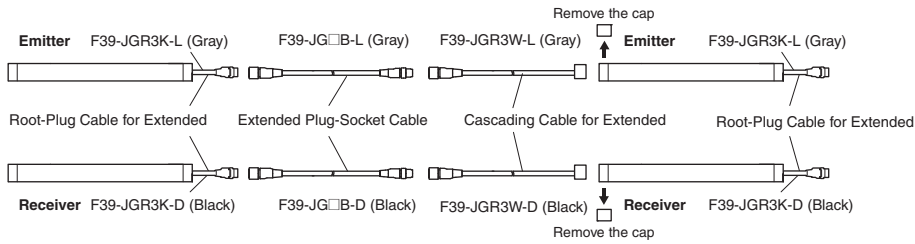

**Conversion Cable**

Appearance	Type	Cable length	Specifications	Model
	F3SJ-B/A Conversion Cable For emitter To sensor: dedicated connector 1, To wires for F3SJ-B/-A, F3SR or F3SN: M12 connector type (8 pin) Color: Gray	0.3 m	Used to convert the wiring for F3SJ-B/-A, F3SR-B or F3SN Safety Light Curtain to that for the F3SG-SR.	F39-JGR3K-SJ-L
	F3SJ-B/A Conversion Cable For emitter To sensor: dedicated connector 1, To wires for F3SJ-B/-A, F3SR or F3SN: M12 connector type (8 pin) Color: Black			F39-JGR3K-SJ-D
	F3SG-RE Conversion Cable For emitter To sensor: dedicated connector 1, To wires for F3SG-RE: M12 connector type (4 pin) Color: Gray	0.3 m	Used to convert the wiring for F3SG-RE Safety Light Curtain to that for the F3SG-SR.	F39-JGR3K-RE-L
	F3SG-RE Conversion Cable For receiver To sensor: dedicated connector 1, To wires for F3SG-RE: M12 connector type (4 pin) Color: Black			F39-JGR3K-RE-D
	MS48 Conversion Cable For emitter To sensor: dedicated connector 1, To wires for MS4800: M12 connector type (5 pin) Color: Gray	0.3 m	Used to convert the wiring for MS4800 Safety Light Curtain to that for the F3SG-SR.	F39-JGR3K-MS-L
	MS48 Conversion Cable For receiver To sensor: dedicated connector 1, To wires for MS4800: M12 connector type (8 pin) Color: Black			F39-JGR3K-MS-D

**Note:** Cables are not included with the safety light curtain/safety multi-light beam.

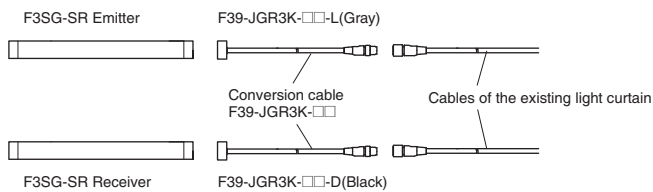

When connecting to the cables of the existing light curtain, order the conversion cables.

Conversion cables are only for PNP connection. To use for NPN, connect the 24 VDC line and the 0 VDC line in reverse. For details, refer to *User's Manual* (Man. No. Z405).



## Intelligent Tap and Configuration Tool SD Manager 3

### Intelligent Tap \*

Appearance	Type	Specifications	Model
	Intelligent Tap	Used to configure the F3SG-SR/PG and connect external devices via IO-Link. The F3SG-SR/PG can be configured on a PC or with the DIP switch on the Intelligent Tap. IP67 and IP67G (JIS C 0920 Annex 1) rated when mated.	<b>F39-SGIT-IL3</b>
	Bluetooth® Communication Unit * For the regions where the Bluetooth® Communication Unit can be used, refer to <i>Legislation and Standards</i> on page 62.	Mounted to the Intelligent Tap to connect with the SD Manager 3 via Bluetooth®. IP67 and IP67G (JIS C 0920 Annex 1) rated when mated.	<b>F39-SGBT</b>
	Intelligent Tap Bracket For DIN in Panel	Bracket to mount the Intelligent Tap on a DIN track.	<b>F39-LITF1</b>

**Note:** Please contact your OMRON sales representative regarding the IO-Link setup file (IODD file).

\* Use the F39-SGBT Bluetooth® Communication Unit or a commercially available USB Type-C™ cable to connect to a PC.

### Configuration tool SD Manager 3

Type	Specifications
SD Manager 3	Configuration tool running on a PC. Use with the Intelligent Tap. (The Bluetooth® communication unit is required to connect using Bluetooth®.) For details, refer to your local Omron website.
SD Manager 3 Mobile APP	Monitoring tool running on a smartphone. Use with the Intelligent Tap and Bluetooth® communication unit. For details, refer to your local Omron website.

### Intelligent Tap-to-IO-Link Master Cable

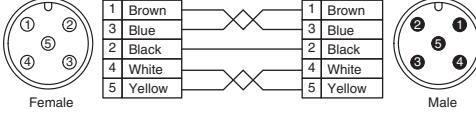
Omron IO-Link master unit	Type	Cable length	Specifications	Model															
NX-ILM400	Single-ended cable M12 connector (5-pin), 5 wires Color: Gray	2 m	 <table border="1"> <tr><td>1</td><td>L+</td><td>Brown</td></tr> <tr><td>2</td><td>DO</td><td>White</td></tr> <tr><td>3</td><td>L-</td><td>Blue</td></tr> <tr><td>4</td><td>C/Q</td><td>Black</td></tr> <tr><td>5</td><td>Not used</td><td>Yellow</td></tr> </table> <p>Female IP67* rated when mated.</p>	1	L+	Brown	2	DO	White	3	L-	Blue	4	C/Q	Black	5	Not used	Yellow	<b>XS5F-D521-DJ0-IL</b>
1	L+	Brown																	
2	DO	White																	
3	L-	Blue																	
4	C/Q	Black																	
5	Not used	Yellow																	
GX-ILM08C	Double-ended cable M12 connector (5-pin), 5 wires Color: Gray	3 m	 <p>Female IP67* rated when mated.</p>	<b>F39-JG3B-L</b>															
		10 m		<b>F39-JG10B-L</b>															
		20 m		<b>F39-JG20B-L</b>															

\* When the accessory is used, protect it from cutting oil.

**Note:** Use the F39-JG□A-D Extended Socket-Straight Cable or F39-JG□B-D Extended Plug-Socket Cable for safety output (OSSD).

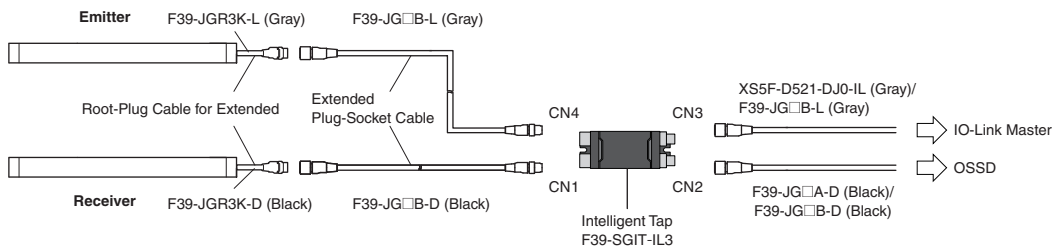

**Reduced Wiring System**  
**Y-Joint Plug/Socket Connector**

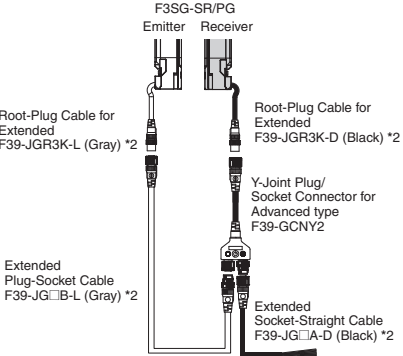
Appearance	Type	Cable length	Specifications	Model
	M12 connectors. Used for reduced wiring. IP67*1 rated when mated.	0.5 m		<b>F39-GCNY2</b>

\*1. When the accessory is used, protect it from cutting oil.

\*2. Order the cable (root-plug cable for extended and extended cable) for emitter (end of model: -L) and the cable for receiver (end of model: -D).

**Reset Switch Connector**

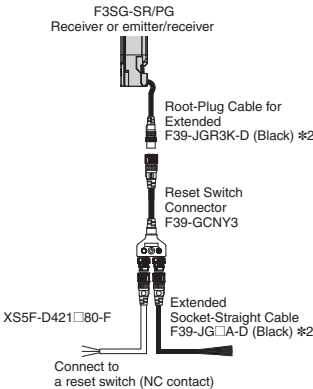
Appearance	Type	Cable length	Specifications	Model
	M12 connectors. Used for reduced wiring. IP67*1 rated when mated.	0.5 m		<b>F39-GCNY3</b>

**Note:** The customer needs to prepare a reset switch (NC contact).

\*1. When the accessory is used, protect it from cutting oil.

\*2. Order the extended socket-straight cable for receiver (end of model: -D).

**Reset Switch Connector-to-Reset Switch Cable**

Connector Connected to Cable, Socket on One Cable End

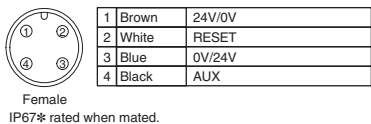
Appearance	Type	Cable length	Specifications	Model
	M12 connector (4-pin), 4 wires	1 m	 <p>Female IP67* rated when mated.</p>	<b>XS5F-D421-C80-F</b>
		2 m		<b>XS5F-D421-D80-F</b>
		3 m		<b>XS5F-D421-E80-F</b>
		5 m		<b>XS5F-D421-G80-F</b>
		10 m		<b>XS5F-D421-J80-F</b>
		20 m		<b>XS5F-D421-L80-F</b>

\* When the accessory is used, protect it from cutting oil.

## Muting System Scheduled for release

### Muting Sensor Arm Mounter (Two mounters per set, for emitter and receiver)

Appearance	Application	Length	Model
	The through-beam muting sensor can be mounted easily.	150 mm	F39-FMA150T
		400 mm	F39-FMA400T
	The retroreflective muting sensor can be mounted easily.	150 mm	F39-FMA150R
		400 mm	F39-FMA400R

**Note:** 1. The muting sensor and reflector are sold separately.

2. When mounting the muting sensor arm mounter to the safety light curtain, order the F39-LMAF1 Muting Sensor Arm Mounter Bracket for SLC. When the muting sensor arm mounter is mounted to the floor mount column, no brackets are required.

### Muting Sensor Arm Mounter Bracket for SLC (Two brackets per set, for emitter and receiver) \*

Appearance	Application	Model
---	For F3SG-SR/PG	F39-LMAF1

\* Order when mounting the muting sensor arm mounter to the safety light curtain. When the muting sensor arm mounter is mounted to the floor mount column, no brackets are required.

### Muting Sensor

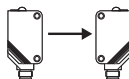
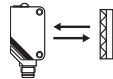
Mounter	Sensing method	Sensing distance	Output type	Model
F39-FMA□□□T	Through-beam 	10 m	NPN output	E3Z-T66A
			PNP output	E3Z-T86A
F39-FMA□□□R	Retro-reflective *1 	4 m *2	NPN output	E3Z-R66
			PNP output	E3Z-R86
			Reflectors	E39-R1S



**Note:** The muting sensor is not included with the muting sensor arm mounter. Order the E3Z Muting Sensor.

\*1. The reflector is not included with the muting sensor. Order the E39-R1S Reflector when using the E3Z-R□6 Retroreflective Muting Sensor.

\*2. The minimum required distance between the E3Z Muting Sensor and reflector is 100 mm.

For details, refer to your local Omron website.

**Muting Sensor Connection Box** Scheduled for release

Appearance	Application	Specifications	Cable Length	Model
	Speeds up wiring muting sensors.	PNP/NPN selection Main Unit: M12 socket (5 pin) ×7, M12 socket (8 pin) ×1 Cable: M12 plug (8 pin) ×1 IP67* rated when mated.	0.5 m	<b>F39-GCN5</b>
	Cable to connect the E3Z Muting Sensor and F39-GCN5 Muting Sensor Connection Box.	Connectors connected to cable, M8 socket and M12 plug on cable ends (4 pin)	0.2 m	<b>XS3W-M42C-4C2-A</b>
	Used together with the XS3W-M42C-4C2-A to extend the cable length between the E2Z Muting Sensor and muting sensor connection box to more than 0.2 m.	Connectors connected to cable, M12 socket and M12 plug on cable ends (4 pin)	1 m	<b>XS5W-D421-C81-F</b>
			2 m	<b>XS5W-D421-D81-F</b>
			3 m	<b>XS5W-D421-E81-F</b>
			5 m	<b>XS5W-D421-G81-F</b>
			10 m	<b>XS5W-D421-J81-F</b>
20 m	<b>XS5W-D421-L81-F</b>			

\* When the accessory is used, protect it from cutting oil.

- Note:**
1. Select the same output type for both the safety light curtain/safety multi-light beam (PNP/NPN selection by wiring) and muting sensor (PNP or NPN model).
  2. For details of the XS3W and XS5W, refer to your local OMRON website.
  3. Use the F39-JG□B-D Extended Plug-Socket Cable to connect the muting sensor connection box with the Intelligent Tap. The connection example for optical synchronization is shown below.

<Connection example>

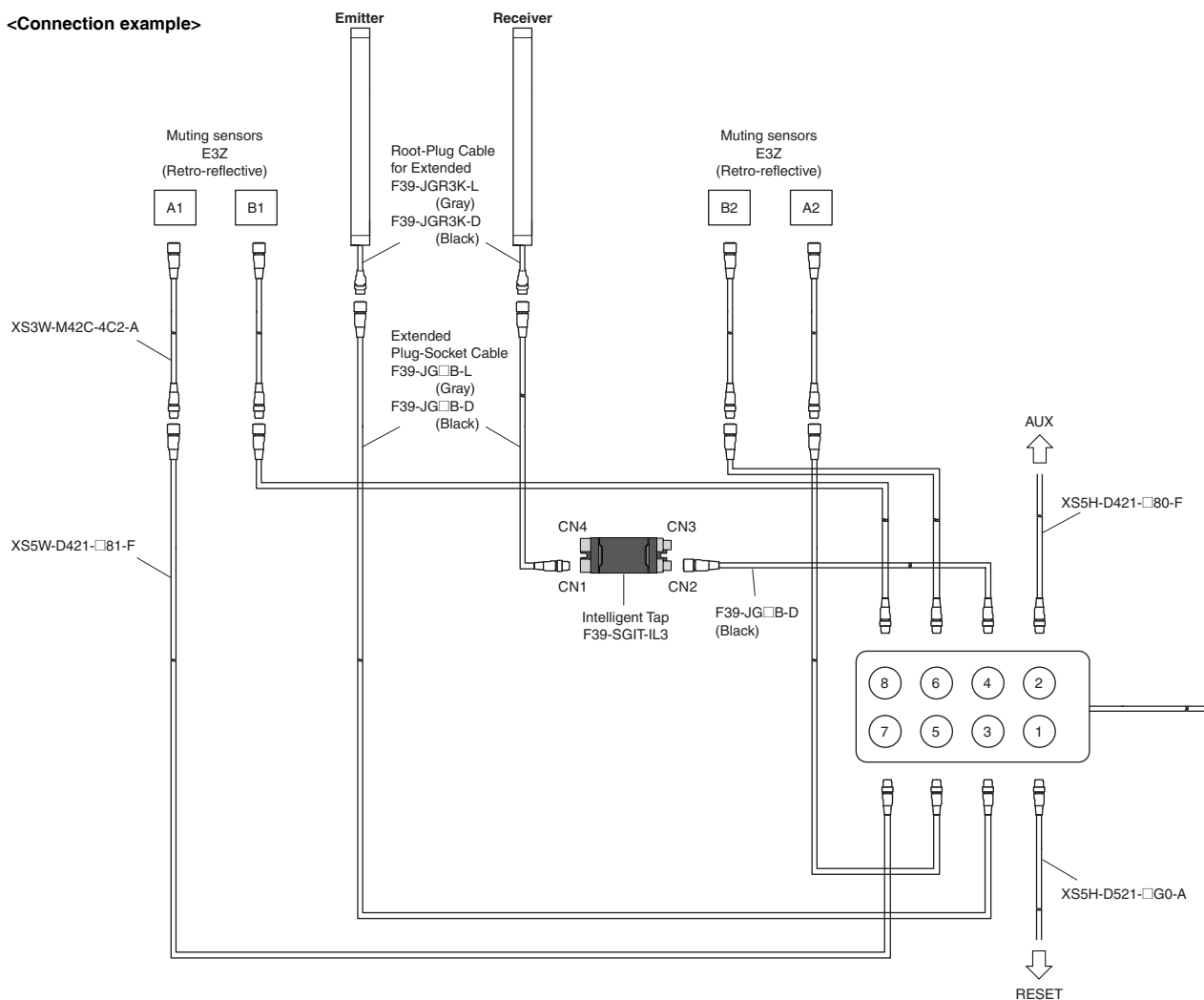

# F3SG-SR/PG

## Floor Mount System Scheduled for release

### Floor Mount Column

Appearance	Protective height of safety light curtain		Column height	Model
	Safety light curtain	Safety multi-light beam		
	Up to 0880	0670	990 mm	F39-ST0990
	Up to 1280	0970, 1070	1,310 mm	F39-ST1310
	Up to 1520	1370	1,630 mm	F39-ST1630
	Up to 1840	---	1,950 mm	F39-ST1950
	Up to 2080	---	2,270 mm	F39-ST2270

### Mirror Column (for F3SG-SR Safety Light Curtain)

Appearance	Protective height of safety light curtain	Column height	Model
	Up to 0800	990 mm	F39-SML0990
	Up to 1120	1,310 mm	F39-SML1310
	Up to 1440	1,630 mm	F39-SML1630
	Up to 1760	1,950 mm	F39-SML1950
	Up to 2080	2,270 mm	F39-SML2270

**Note:** The F3SG-SR Safety Light Curtain with the protective height of 2280 or more cannot be used.

### Mirror Column For Multiple Beam (for F3SG-PG Safety Multi-Light Beam)

Appearance	Safety Multi-Light Beam	Column height	Model
	F3SG-4PG0670-2□	990 mm	F39-PML0990-2
	F3SG-4PG0970-3A/3L	1,310 mm	F39-PML1310-3
	F3SG-4PG1070-4□		F39-PML1310-4
	F3SG-4PG1370-4□	1,630 mm	F39-PML1630-4

### Mount-Column Adjustable Base

Appearance	Application	Model
	Mounted to the floor mount column or mirror column. The angle and height of the column can be adjusted.	F39-STB

### Laser Alignment Pointer

Appearance	Specifications	Model
	The laser alignment pointer is attached on the optical surface of the F3SG-SR/PG to help coarse adjustment of beams.	<b>F39-PTG</b>

### Lamp Scheduled for release

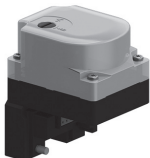
Appearance	Specifications	Model
	The lamp can be connected to emitter, receiver, or emitter/receiver and turned ON based on the operation of F3SG-SR/PG. The lamp can indicate red, orange, and green colors, to which three different states can be assigned. IP67 * rated when mated.	<b>F39-SGLP</b>

\* When the accessory is used, protect it from cutting oil.  
**Note:** The Lamp does not support Bluetooth® communication.

### Test Rod \*

Diameter	Model
14 mm dia.	<b>F39-TRD14</b>
25 mm dia.	<b>F39-TRD25</b>

\* The customer needs to prepare a test rod larger than 25-mm dia.

## Spatter Protection Cover (2 covers per set, one for emitter and one for receiver) Scheduled for release

Appearance	Safety light curtain			Model
	Finger protection	Hand protection	Arm/leg protection	
	F3SG-4SR□0160-14	F3SG-4SR□0160-25	---	F39-HSG0160
	F3SG-4SR□0240-14	F3SG-4SR□0240-25	F3SG-4SR□0240-45	F39-HSG0240
	F3SG-4SR□0320-14	F3SG-4SR□0320-25	---	F39-HSG0320
	F3SG-4SR□0400-14	F3SG-4SR□0400-25	F3SG-4SR□0400-45	F39-HSG0400
	F3SG-4SR□0480-14	F3SG-4SR□0480-25	---	F39-HSG0480
	F3SG-4SR□0560-14	F3SG-4SR□0560-25	F3SG-4SR□0560-45	F39-HSG0560
	F3SG-4SR□0640-14	F3SG-4SR□0640-25	---	F39-HSG0640
	---	F3SG-4SR□0720-25	F3SG-4SR□0720-45	F39-HSG0720
	F3SG-4SR□0800-14	F3SG-4SR□0800-25	---	F39-HSG0800
	---	F3SG-4SR□0880-25	F3SG-4SR□0880-45	F39-HSG0880
	F3SG-4SR□0960-14-F	F3SG-4SR□0960-25	---	F39-HSG0960
	---	F3SG-4SR□1040-25	---	F39-HSG1040
	---	F3SG-4SR□1120-25	---	F39-HSG1120
	F3SG-4SR□1200-14	F3SG-4SR□1200-25	F3SG-4SR□1200-45	F39-HSG1200
	---	F3SG-4SR□1280-25	---	F39-HSG1280
	---	F3SG-4SR□1360-25	---	F39-HSG1360
	---	F3SG-4SR□1440-25	---	F39-HSG1440
	---	F3SG-4SR□1520-25	F3SG-4SR□1520-45	F39-HSG1520
	F3SG-4SR□1600-14	F3SG-4SR□1600-25	---	F39-HSG1600
	---	F3SG-4SR□1680-25	---	F39-HSG1680
---	F3SG-4SR□1760-25	---	F39-HSG1760	
---	F3SG-4SR□1840-25	---	F39-HSG1840	
---	F3SG-4SR□1920-25	---	F39-HSG1920	

- Note:**
1. The operating range of the safety light curtain attached with the spatter protection cover is 10% shorter than the rating.
  2. Two or more spatter protection covers can be attached to the safety light curtain with a protective height not listed above. The F39-HSG0360 is also available for use together with other spatter protection covers.

# Ratings and Specifications

## Safety Light Curtain F3SG-SR Series Main unit

The □□□□ in the model names indicate the protective heights in millimeters.

Model		F3SG-□SR□□□□-14 F3SG-□SRB□□□□-14	F3SG-□SR□□□□-25 F3SG-□SRB□□□□-25	F3SG-□SR□□□□-45 F3SG-□SRB□□□□-45	F3SG-□SR□□□□-85 F3SG-□SRB□□□□-85	
Performance	Object resolution (Detection capability)	Opaque objects				
	Beam gap	14-mm dia.	25-mm dia.	45-mm dia.	85-mm dia.	
	Number of beams	10 mm	20 mm	40 mm	80 mm	
	Lens size	15 to 199	8 to 124	6 to 38	4 to 12	
	Protective height	4.4 × 3.4 mm (W × H)	6.7 × 4.5 mm (W × H)			
	Operating range	Long	160 to 2,000 mm	160 to 2,480 mm	240 to 1,520 mm	280 to 920 mm
		Short	0.3 to 10.0 m *	0.3 to 20.0 m		
	* When operating at an ambient temperature of -10 to -30°C, use the F3SG-SR with the operating range of 0.3 to 5.0 m in Long Mode and 0.3 to 1.5 m in Short Mode.					
	Response time *1	Normal mode	ON to OFF	Optical synchronization: 8 to 18 ms Wired synchronization: 10 to 21 ms	Optical synchronization: 8 to 13 ms Wired synchronization: 10 to 17 ms	Optical synchronization: 8 ms Wired synchronization: 10 ms
			OFF to ON	Optical synchronization: 40 to 90 ms Wired synchronization: 50 to 105 ms	Optical synchronization: 40 to 65 ms Wired synchronization: 50 to 85 ms	Optical synchronization: 40 ms Wired synchronization: 50 ms
×2 Slow mode *2		ON to OFF	Optical synchronization: 16 to 36 ms Wired synchronization: 20 to 42 ms	Optical synchronization: 16 to 26 ms Wired synchronization: 20 to 34 ms	Optical synchronization: 16 ms Wired synchronization: 20 ms	
		OFF to ON	Optical synchronization: 80 to 180 ms Wired synchronization: 100 to 210 ms	Optical synchronization: 80 to 130 ms Wired synchronization: 100 to 170 ms	Optical synchronization: 80 ms Wired synchronization: 100 ms	
×4 Slow mode *2		ON to OFF	Optical synchronization: 32 to 72 ms Wired synchronization: 40 to 84 ms	Optical synchronization: 32 to 52 ms Wired synchronization: 40 to 68 ms	Optical synchronization: 32 ms Wired synchronization: 40 ms	
		OFF to ON	Optical synchronization: 160 to 360 ms Wired synchronization: 200 to 420 ms	Optical synchronization: 160 to 260 ms Wired synchronization: 200 to 340 ms	Optical synchronization: 160 ms Wired synchronization: 200 ms	
×8 Slow mode *2		ON to OFF	Optical synchronization: 64 to 144 ms Wired synchronization: 80 to 168 ms	Optical synchronization: 64 to 104 ms Wired synchronization: 80 to 136 ms	Optical synchronization: 64 ms Wired synchronization: 80 ms	
		OFF to ON	Optical synchronization: 320 to 720 ms Wired synchronization: 400 to 840 ms	Optical synchronization: 320 to 520 ms Wired synchronization: 400 to 680 ms	Optical synchronization: 320 ms Wired synchronization: 400 ms	
*1. Response time when used in one segment system. Refer to page 55. Refer to the User's Manual (Man. No. Z405) for cascaded connection.						
*2. Selectable by SD Manager 3.						
Effective aperture angle (EAA) (IEC 61496-2)		Type 4	±2.5° max. *			
		Type 2	±5.0° max. *			
* Emitter and receiver at operating range of 3 m or greater.						
Light source		Infrared LEDs, Wavelength: 870 nm				
Startup waiting time		3 s max.				
Electrical	Power supply voltage (Vs)	SELV/PELV 24 VDC±20% (ripple p-p 10% max.)				
	Current consumption	Refer to page 55				
	Safety outputs (OSSD)	Two PNP or NPN transistor outputs (PNP or NPN is selectable by wiring of power supply.) Load current: 300 mA max., Residual voltage: 2 V max. (except for voltage drop due to cable extension), Capacitive load: 1 μF max., Inductive load: 2.2 H max. *1*2*3 Leakage current: 1 mA max.(PNP), 2 mA max.(NPN) *4 *1. For the F3SG-□SR□□□□, the load current is 150 mA max. in 2-segment cascade and 80 mA max. in 3-segment cascade. *2. The residual voltage is 3 V max. when the Intelligent Tap is connected to the sensor. *3. The load inductance is the maximum value when the safety output frequently repeats ON and OFF. When you use the safety output at 4 Hz or less, the usable load inductance becomes larger. *4. These values must be taken into consideration when connecting elements including a capacitive load such as a capacitor.				
	Auxiliary output	One PNP or NPN transistor output (PNP or NPN is selectable by wiring of power supply.) Load current: 100 mA max., Residual voltage: 2 V max. * * The residual voltage is 3 V max. when the Intelligent Tap is connected to the sensor.				
Output operation mode	Safety output	Light-ON (Safety outputs are turned to the ON state when the receiver receives an emitting signal.)				
	Auxiliary output	Safety output (Inverted signal output: Enable) (default) (Configurable by SD Manager 3)				

Ordering Information  
Ratings and Specifications

Model		F3SG-□SRA□□□□-14 F3SG-□SRB□□□□-14	F3SG-□SRA□□□□-25 F3SG-□SRB□□□□-25	F3SG-□SRA□□□□-45 F3SG-□SRB□□□□-45	F3SG-□SRA□□□□-85 F3SG-□SRB□□□□-85	
Electrical	Input voltage	TEST	Light emission stops when connected to 24 V DC ON voltage: Vs-3 V to Vs (short circuit current: approx. 5.0 mA) * OFF voltage: 0 V to 1/2 Vs, or open (short circuit current: approx. 6.0 mA) * Light emission stops when connected to 0 V ON voltage: 0 to 3 V (short circuit current: approx. 6.0 mA) OFF voltage: 1/2 Vs to Vs, or open (short circuit current: approx. 5.0 mA) *			
		OPERATING RANGE SELECT INPUT	Long: 12 V to Vs (short circuit current: approx. 4.2 mA) * or open Short: 0 to 3 V (short circuit current: approx. 4.2 mA)			
		RESET/EDM	PNP ON voltage: Vs-3 V to Vs (short circuit current: approx. 9.5 mA) * OFF voltage: 0 V to 1/2 Vs, or open (short circuit current: approx. 13.0 mA) * NPN ON voltage: 0 to 3 V (short circuit current: approx. 13.0 mA) OFF voltage: 1/2 Vs to Vs, or open (short circuit current: approx. 9.5 mA) *			
		MUTE A/B, RE-RESET, PSDI	PNP ON voltage: Vs-3 V to Vs (short circuit current: approx. 4.5 mA) * OFF voltage: 0 V to 1/2 Vs, or open (short circuit current: approx. 7.0 mA) * NPN ON voltage: 0 to 3 V (short circuit current: approx. 7.0 mA) OFF voltage: 1/2 Vs to Vs, or open (short circuit current: approx. 4.5 mA) *			
			* The Vs indicates a supply voltage value in your environment.			
	Overvoltage category (IEC 60664-1)		II			
	Indicators		Refer to page 63			
	Protective circuit		Output short-circuit protection			
	Insulation resistance		20 MΩ or higher (500 VDC megger)			
	Dielectric strength		1,000 VAC, 50/60 Hz (1 min)			
Functional	Mutual interference prevention		Optical synchronization by Scan Code: in up to 2 sets Wired synchronization: in up to 3 sets			
	Cascade connection		Number of cascaded segments: 3 max. Total number of beams: 255 max.			
	Test function		Self-test (at power-on, and during operation) External test (light emission stop function by test input)			
	Safety-related functions		Interlock External Device Monitoring (EDM) Pre-Reset PSDI Fixed Blanking/Floating Blanking Reduced Resolution Muting/Override Mutual Interference Prevention PNP/NPN Selection Response Time Adjustment			
Environmental	Ambient temperature	Operating	-30 to 55 °C (non-icing)			
		Storage	-30 to 70 °C			
	Ambient humidity	Operating	35% to 85% (non-condensing)			
		Storage	35% to 95%			
	Ambient illuminance		Incandescent lamp: 3,000 lx max. on receiver surface Sunlight: 10,000 lx max. on receiver surface			
	Degree of protection (IEC 60529)		IEC 60529: IP65 and IP67, JIS C 0920 Annex 1: IP67G			
	Vibration resistance (IEC 61496-1)		10 to 55 Hz, Multiple amplitude of 0.7 mm, 20 sweeps for all 3 axes			
	Shock resistance (IEC 61496-1)		100 m/s <sup>2</sup> , 1000 shocks for all 3 axes			
Pollution degree (IEC 60664-1)		3				
Connections	Root cable	Type of connection	To sensors: dedicated connector, To external: M12 connector type (5-pin emitter and 8-pin receiver) or open-ended type IP67 and IP67G (JIS C 0920 Annex 1) * rated when mated. * The F3SG-SR meets the degree of protection when the root cable is correctly connected with the F3SG-SR. The degree of protection is not satisfied with the part where cable wires are uncovered.			
		Number of wires	Emitter: 5, Receiver: 8			
		Cable length	Refer to page 38			
		Cable diameter	6 mm			
		Minimum bending radius	R5 mm			
	Cascading cable	Type of connection	To sensors: dedicated connector, To cascading sensors: M12 connector type (5-pin emitter and 8-pin receiver) or dedicated connector IP67 and IP67G (JIS C 0920 Annex 1) * rated when mated. * The F3SG-SR meets the degree of protection when the cascading cable is correctly connected with the F3SG-SR and the root cable.			
		Number of wires	Emitter: 5, Receiver: 8			
		Cable length	Refer to page 40			
		Cable diameter	6 mm			
		Minimum bending radius	R5 mm			

Model		F3SG-□SRA□□□□-14 F3SG-□SRB□□□□-14	F3SG-□SRA□□□□-25 F3SG-□SRB□□□□-25	F3SG-□SRA□□□□-45 F3SG-□SRB□□□□-45	F3SG-□SRA□□□□-85 F3SG-□SRB□□□□-85
Connections	Extension cable - Extended Socket-Straight Cable - Extended Plug-Socket Cable	Type of connection	M12 connector type (5-pin emitter and 8-pin receiver), IP67 * rated when mated * The extension cable meets the degree of protection when the root cable is correctly connected with the extension cable. The degree of protection is not satisfied with the part where cable wires are uncovered.		
		Number of wires	Emitter: 5, Receiver: 8		
		Cable length	Refer to page 39		
		Cable diameter	6.6 mm		
		Minimum bending radius	R36 mm		
	Cable extension	Refer to page 52 for restrictions on cable extension.			
	Root cable	In optical synchronization: 100 m max. * between power supply and emitter and between power supply and receiver In wired synchronization: 100 m max. * between power supply and emitter, between power supply and receiver, and between emitter and receiver * When the Intelligent Tap (F39-SGIT-IL3) is connected to the sensor, this applies in the case of the rated power supply of 24 VDC to 24 VDC +20%.			
	Cascade connection	Extension cable between sensors: 10 m max. (not including Cascading Cable for Extended *1 and Root Cable *2.) *1. F39-JGR3W *2. F39-JGR3K			
Material	Housing: Aluminum alloy Cap: PBT resin Front window: Acrylic resin Side-Mount Bracket (Intermediate Bracket)(F39-LSGF): Zinc alloy FE plate: Stainless steel				
Weight	Refer to page 55				
Included accessories	Instruction Sheet, Quick Installation Manual, Troubleshooting Guide Sticker, Warning Zone Label, End Cap (for switching Scan Code Selection function), Side-Mount Bracket (Intermediate Bracket) (F39-LSGF) * * The quantity varies depending on the protective height. Protective height of 0160 to 1440: 2 sets (total 4 pcs), 1520 to 2480: 3 sets (total 6 pcs)				
Conformity	Conforming standards	Refer to page 62			
	Type of ESPE (IEC 61496-1)	F3SG-4SR□□□□-□□: Type 4 F3SG-2SR□□□□-□□: Type 2			
	Performance Level (PL)/Safety category	F3SG-4SR□□□□-□□: PL e/Category 4 (EN ISO 13849-1:2015) F3SG-2SR□□□□-□□: PL c/Category 2 (EN ISO 13849-1:2015)			
	PFH <sub>b</sub>	F3SG-□SR□□□□-□□: 1.1×10 <sup>-8</sup> max. (IEC 61508)			
	Proof test interval T <sub>M</sub>	Every 20 years (IEC 61508)			
	SFF	99% (IEC 61508)			
	HFT	1 (IEC 61508)			
Classification	Type B (IEC 61508-2)				

## Restrictions on cable extension

For the cable extension of the F3SG-SR, refer to the following diagrams. For the cable extension of the F3SG-SR with the Intelligent Tap, refer to *User's Manual* (Man. No. Z405).

### - Wired synchronization

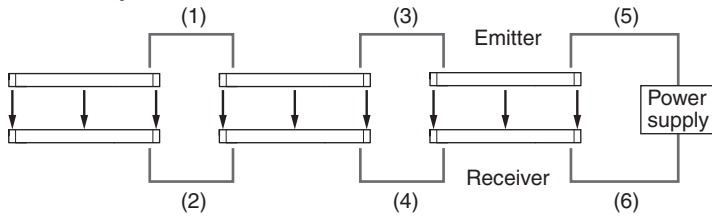

Maximum extension length
(1) to (4): 10 m each *
(5) to (6): 100 m each

### - Optical synchronization

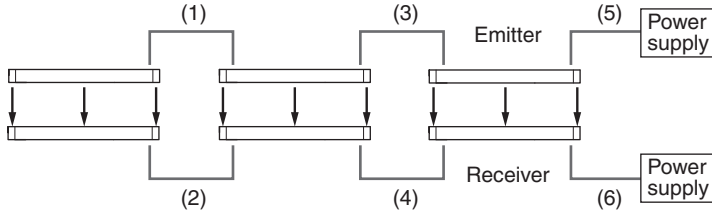

Maximum extension length
(1) to (4): 10 m each *
(5) to (6): 100 m each

\* Not including Cascading Cable for Extended (F39-JGR3W) and Root Cable (F39-JGR3K).

## Intelligent Tap F39-SGIT-IL3

Model		F39-SGIT-IL3	
Applicable sensor		F3SG-SR Series	
Performance	Response time	Output ON to OFF and OFF to ON: 44 ms max. each * * The response time is the time interval between the changes of the states of the sensor OSSD's and the DO (pin 2).	
	Startup waiting time	3 s max.	
Electrical	Power supply voltage (Vs)	Supplied from external power source: SELV/PELV 24 VDC±20% (ripple p-p 10% max.) USB bus powered: 5 VDC	
	Current consumption	85 mA max. (When connecting 24 VDC power supply and IO-Link Master)	
	Safety outputs (OSSD) /Auxiliary output	Refer to the ratings and specifications of the F3SG-SR. The safety outputs and auxiliary output of the Intelligent Tap are directly connected to those of the F3SG-SR.	
	Digital output for pin 2 (IO-Link) *	One PNP transistor output Load current: 100 mA max., Residual voltage: 2 V max., Leakage current: 1 mA max. The DO is in the OFF state when the safety outputs are in the ON state. The DO is in the ON state when the safety outputs are in the OFF state. (Regardless of the PNP/NPN setting of the F3SG-SR)	
	* For the DO (pin 2) of CN3		
	Input voltage	RESET, EDM	PNP ON voltage: Vs-3 V to Vs (short circuit current: approx. 9.5 mA) *2 OFF voltage: 0 V to 1/2 Vs, or open (short circuit current: approx. 13.0 mA) *2 NPN ON voltage: 0 to 3 V (short circuit current: approx. 13.0 mA) OFF voltage: 1/2 Vs to Vs, or open (short circuit current: approx. 9.5 mA) *2
		MUTE A/B, PRE-RESET, PSDI *1	PNP ON voltage: Vs-3 V to Vs (short circuit current: approx. 4.5 mA) *2 OFF voltage: 0 V to 1/2 Vs, or open (short circuit current: approx. 7.0 mA) *2 NPN ON voltage: 0 to 3 V (short circuit current: approx. 7.0 mA) OFF voltage: 1/2 Vs to Vs, or open (short circuit current: approx. 4.5 mA) *2
	*1. PSDI is only available for F3SG-SR. *2. The Vs indicates a supply voltage value in your environment.		
	Overvoltage category (IEC 60664-1)	II	
	Protective circuit	Output short-circuit protection, Output reverse polarity protection	
Insulation resistance	20 MΩ or higher (500 VDC megger)		
Dielectric strength	1,000 VAC, 50/60 Hz (1 min)		
Functional	Maintenance Information	Error Log Power-ON Time	
Environmental	Ambient temperature	Operating	-30 to 55 °C (non-icing)
		Storage	-30 to 70 °C
	Ambient humidity	Operating	35% to 85% (non-condensing)
		Storage	35% to 85%
	Degree of protection (IEC 60529)	IP65, IP67 and IP67G (Covers and cables connected with the Intelligent Tap.)	
	Vibration resistance (IEC 61496-1)	10 to 55 Hz, Multiple amplitude of 0.7 mm, 20 sweeps for all 3 axes	
Shock resistance (IEC 61496-1)	100 m/s <sup>2</sup> , 1000 shocks for all 3 axes		
Pollution degree (IEC 60664-1)	3		
Connections	To sensors, control box and IO-Link	M12 connectors: 8-pin (CN1: receiver and CN2: control box) and 5-pin (CN3: IO-Link and CN4: emitter), IP67 and IP67G (JIS C 0920 Annex 1) * rated when mated. * The F3SG-SR meets the degree of protection when the root cable of the F3SG-SR is correctly connected with the F3SG-SR.	
	Connection	USB Type-C	
	Cable extension	20 m max. between IO-Link Master and Intelligent Tap, 4 m max.* between PC and Intelligent Tap via USB cable * It is not guaranteed that the Intelligent Tap is connectable to any PC or USB cable. Verify the connection with the USB cable you use.	
IO-Link communications	IO-Link version	Version 1.1	
	Baud rate	COM3: 230.4 kbps	
	Data length	PD: 4 bytes, OD: 32 bytes (M-sequence type: TYPE_2_V)	
	Minimum cycle time	12 ms	
Material	PBT resin		
Weight	F39-SGIT-IL3: 180 g (when packaged), F39-LITF1: 50 g (when packaged)		
Included accessories	Instruction Sheet and M12 Connector Cover (2 pcs)		

## Bluetooth® Communication Unit

Model	F39-SGBT
<b>Applicable sensor</b>	F3SG-SR Series
<b>Power supply voltage (Vs)</b>	24 VDC±20%, ripple p-p 10% max. (shares power supply of Intelligent Tap)
<b>Current consumption</b>	30 mA max. (shares power supply of Intelligent Tap)
<b>Ambient temperature</b>	Operating: -30 to 55 °C (non-icing) Storage: -30 to 70 °C
<b>Ambient humidity</b>	Operating: 35% to 85% (non-condensing) Storage: 35% to 85%
<b>Degree of protection</b>	IP65, IP67 and IP67G (rated when connected to Intelligent Tap)
<b>Vibration resistance</b>	10 to 55 Hz, Multiple amplitude of 0.7 mm, 20 sweeps for all 3 axes
<b>Shock resistance</b>	100m/s <sup>2</sup> , 1000 shocks for all 3 axes
<b>Type of connection</b>	To be connected to Intelligent Tap
<b>Communication system</b>	Bluetooth® Version 3.0
<b>Communication profile</b>	SPP (Serial Port Profile)
<b>Transmission distance</b>	Approx. 10 m max. (Output power: Class 2) *
<b>Material</b>	PBT resin
<b>Weight</b>	70 g (when packaged)

\* It depends on use environment conditions.

## List of Models/Response Time/Current Consumption/Weight

### F3SG-SR

Finger protection (Detection capability: 14-mm dia.)

List of Models and Response Times

Model		Number of beams	Protective height [mm]	Response time (Optical synchronization) [ms]			Response time (Wired synchronization) [ms]	
				ON to OFF	OFF (synchronized) to ON	OFF (not synchronized) to ON	ON to OFF	OFF to ON
F3SG-4SR□0160-14	F3SG-2SRB0160-14	15	160	8	40	140	10	50
F3SG-4SR□0200-14-F	---	19	200	8	40	140	10	50
F3SG-4SR□0240-14	F3SG-2SRB0240-14	23	240	8	40	140	10	50
F3SG-4SR□0280-14-F	---	27	280	8	40	140	10	50
F3SG-4SR□0320-14	F3SG-2SRB0320-14	31	320	8	40	140	10	50
F3SG-4SR□0360-14-F	---	35	360	8	40	140	10	50
F3SG-4SR□0400-14	F3SG-2SRB0400-14	39	400	8	40	140	10	50
F3SG-4SR□0440-14-F	---	43	440	13	65	165	17	85
F3SG-4SR□0480-14	F3SG-2SRB0480-14	47	480	13	65	165	17	85
F3SG-4SR□0520-14-F	---	51	520	13	65	165	17	85
F3SG-4SR□0560-14	F3SG-2SRB0560-14	55	560	13	65	165	17	85
F3SG-4SR□0600-14-F	---	59	600	13	65	165	17	85
F3SG-4SR□0640-14	F3SG-2SRB0640-14	63	640	13	65	165	17	85
F3SG-4SR□0680-14-F	---	67	680	13	65	165	17	85
F3SG-4SR□0720-14-F	---	71	720	13	65	165	17	85
F3SG-4SR□0760-14-F	---	75	760	13	65	165	17	85
F3SG-4SR□0800-14	F3SG-2SRB0800-14	79	800	13	65	165	17	85
F3SG-4SR□0840-14-F	---	83	840	13	65	165	17	85
F3SG-4SR□0880-14-F	---	87	880	13	65	165	17	85
F3SG-4SR□0920-14-F	---	91	920	13	65	165	17	85
F3SG-4SR□0960-14-F	---	95	960	13	65	165	17	85
F3SG-4SR□1000-14	F3SG-2SRB1000-14	99	1000	13	65	165	17	85
F3SG-4SR□1200-14	F3SG-2SRB1200-14	119	1200	13	65	165	17	85
F3SG-4SR□1400-14	F3SG-2SRB1400-14	139	1400	13	65	165	17	85
F3SG-4SR□1600-14	F3SG-2SRB1600-14	159	1600	18	90	190	21	105
F3SG-4SR□1800-14	F3SG-2SRB1800-14	179	1800	18	90	190	21	105
F3SG-4SR□2000-14	F3SG-2SRB2000-14	199	2000	18	90	190	21	105

**Note:** 1. The maximum speed of movement of a test rod up to which the detection capability is maintained is 2.0 m/s.

2. The response times of "Optical synchronization" are values when Scan Code is set at Code B. The response times for Code A are 1 ms shorter than these values.

# F3SG-SR/PG

## List of Models, Current Consumption and Weight

Model	Number of beams	Protective height [mm]	Current consumption [mA]		Weight [kg]	
			Emitter	Receiver	Net	Gross
F3SG-4SRA0160-14	15	160	68	106	0.4	1.2
F3SG-□SRB0160-14	15	160	69	97	0.4	1.2
F3SG-4SRA0200-14-F	19	200	71	108	0.5	1.3
F3SG-4SRB0200-14-F	19	200	70	97	0.5	1.3
F3SG-4SRA0240-14	23	240	74	111	0.6	1.4
F3SG-□SRB0240-14	23	240	71	98	0.6	1.4
F3SG-4SRA0280-14-F	27	280	77	114	0.7	1.5
F3SG-4SRB0280-14-F	27	280	73	99	0.7	1.5
F3SG-4SRA0320-14	31	320	81	117	0.8	1.6
F3SG-□SRB0320-14	31	320	74	100	0.8	1.6
F3SG-4SRA0360-14-F	35	360	84	119	0.9	1.8
F3SG-4SRB0360-14-F	35	360	75	100	0.9	1.8
F3SG-4SRA0400-14	39	400	87	122	1	1.9
F3SG-□SRB0400-14	39	400	77	101	1	1.9
F3SG-4SRA0440-14-F	43	440	90	125	1.1	2
F3SG-4SRB0440-14-F	43	440	78	102	1.1	2
F3SG-4SRA0480-14	47	480	93	128	1.2	2.1
F3SG-□SRB0480-14	47	480	79	103	1.2	2.1
F3SG-4SRA0520-14-F	51	520	96	131	1.3	2.2
F3SG-4SRB0520-14-F	51	520	81	103	1.3	2.2
F3SG-4SRA0560-14	55	560	99	133	1.4	2.3
F3SG-□SRB0560-14	55	560	82	104	1.4	2.3
F3SG-4SRA0600-14-F	59	600	103	136	1.5	2.5
F3SG-4SRB0600-14-F	59	600	83	105	1.5	2.5
F3SG-4SRA0640-14	63	640	106	139	1.6	2.6
F3SG-□SRB0640-14	63	640	85	106	1.6	2.6
F3SG-4SRA0680-14-F	67	680	109	142	1.7	2.7
F3SG-4SRB0680-14-F	67	680	86	106	1.7	2.7
F3SG-4SRA0720-14-F	71	720	112	144	1.8	2.8
F3SG-4SRB0720-14-F	71	720	87	107	1.8	2.8
F3SG-4SRA0760-14-F	75	760	115	147	1.9	2.9
F3SG-4SRB0760-14-F	75	760	89	108	1.9	2.9
F3SG-4SRA0800-14	79	800	118	150	2	3
F3SG-□SRB0800-14	79	800	90	109	2	3
F3SG-4SRA0840-14-F	83	840	121	153	2.1	3.1
F3SG-4SRB0840-14-F	83	840	91	109	2.1	3.1
F3SG-4SRA0880-14-F	87	880	124	155	2.2	3.2
F3SG-4SRB0880-14-F	87	880	93	110	2.2	3.2
F3SG-4SRA0920-14-F	91	920	128	158	2.3	3.4
F3SG-4SRB0920-14-F	91	920	94	111	2.3	3.4
F3SG-4SRA0960-14-F	95	960	131	161	2.4	3.5
F3SG-4SRB0960-14-F	95	960	95	112	2.4	3.5
F3SG-4SRA1000-14	99	1000	134	164	2.5	3.6
F3SG-□SRB1000-14	99	1000	97	112	2.5	3.6
F3SG-4SRA1200-14	119	1200	150	178	3.1	4.2
F3SG-□SRB1200-14	119	1200	103	116	3.1	4.2
F3SG-4SRA1400-14	139	1400	165	191	3.6	4.7
F3SG-□SRB1400-14	139	1400	110	120	3.6	4.7
F3SG-4SRA1600-14	159	1600	181	205	4.1	5.5
F3SG-□SRB1600-14	159	1600	117	124	4.1	5.5
F3SG-4SRA1800-14	179	1800	197	219	4.6	6.1
F3SG-□SRB1800-14	179	1800	124	128	4.6	6.1
F3SG-4SRA2000-14	199	2000	212	233	5.1	6.7
F3SG-□SRB2000-14	199	2000	130	131	5.1	6.7

**Note:** 1. The net weight is the weight of an emitter and a receiver per set.  
 2. The gross weight is the weight of an emitter, a receiver, included accessories and a package.

Hand protection (Detection capability: 25-mm dia.)  
List of Models and Response Times

Model		Number of beams	Protective height [mm]	Response time (Optical synchronization) [ms]			Response time (Wired synchronization) [ms]	
				ON to OFF	OFF (synchronized) to ON	OFF (not synchronized) to ON	ON to OFF	OFF to ON
F3SG-4SR□0160-25	F3SG-2SRB0160-25	8	160	8	40	140	10	50
F3SG-4SR□0200-25-F	---	10	200	8	40	140	10	50
F3SG-4SR□0240-25	F3SG-2SRB0240-25	12	240	8	40	140	10	50
F3SG-4SR□0280-25-F	---	14	280	8	40	140	10	50
F3SG-4SR□0320-25	F3SG-2SRB0320-25	16	320	8	40	140	10	50
F3SG-4SR□0360-25-F	---	18	360	8	40	140	10	50
F3SG-4SR□0400-25	F3SG-2SRB0400-25	20	400	8	40	140	10	50
F3SG-4SR□0440-25-F	---	22	440	8	40	140	10	50
F3SG-4SR□0480-25	F3SG-2SRB0480-25	24	480	8	40	140	10	50
F3SG-4SR□0520-25-F	---	26	520	8	40	140	10	50
F3SG-4SR□0560-25	F3SG-2SRB0560-25	28	560	8	40	140	10	50
F3SG-4SR□0600-25-F	---	30	600	8	40	140	10	50
F3SG-4SR□0640-25	F3SG-2SRB0640-25	32	640	8	40	140	10	50
F3SG-4SR□0680-25-F	---	34	680	8	40	140	10	50
F3SG-4SR□0720-25	F3SG-2SRB0720-25	36	720	8	40	140	10	50
F3SG-4SR□0760-25-F	---	38	760	8	40	140	10	50
F3SG-4SR□0800-25	F3SG-2SRB0800-25	40	800	8	40	140	10	50
F3SG-4SR□0840-25-F	---	42	840	13	65	165	17	85
F3SG-4SR□0880-25	F3SG-2SRB0880-25	44	880	13	65	165	17	85
F3SG-4SR□0920-25-F	---	46	920	13	65	165	17	85
F3SG-4SR□0960-25	F3SG-2SRB0960-25	48	960	13	65	165	17	85
F3SG-4SR□1000-25-F	---	50	1000	13	65	165	17	85
F3SG-4SR□1040-25	F3SG-2SRB1040-25	52	1040	13	65	165	17	85
F3SG-4SR□1120-25	F3SG-2SRB1120-25	56	1120	13	65	165	17	85
F3SG-4SR□1200-25	F3SG-2SRB1200-25	60	1200	13	65	165	17	85
F3SG-4SR□1280-25	F3SG-2SRB1280-25	64	1280	13	65	165	17	85
F3SG-4SR□1360-25	F3SG-2SRB1360-25	68	1360	13	65	165	17	85
F3SG-4SR□1440-25	F3SG-2SRB1440-25	72	1440	13	65	165	17	85
F3SG-4SR□1520-25	F3SG-2SRB1520-25	76	1520	13	65	165	17	85
F3SG-4SR□1600-25	F3SG-2SRB1600-25	80	1600	13	65	165	17	85
F3SG-4SR□1680-25	F3SG-2SRB1680-25	84	1680	13	65	165	17	85
F3SG-4SR□1760-25	F3SG-2SRB1760-25	88	1760	13	65	165	17	85
F3SG-4SR□1840-25	F3SG-2SRB1840-25	92	1840	13	65	165	17	85
F3SG-4SR□1920-25	F3SG-2SRB1920-25	96	1920	13	65	165	17	85
F3SG-4SR□2080-25	F3SG-2SRB2080-25	104	2080	13	65	165	17	85
F3SG-4SR□2280-25	F3SG-2SRB2280-25	114	2280	13	65	165	17	85
F3SG-4SR□2480-25	F3SG-2SRB2480-25	124	2480	13	65	165	17	85

Note: 1. The maximum speed of movement of a test rod up to which the detection capability is maintained is 2.0 m/s.  
2. The response times of "Optical synchronization" are values when Scan Code is set at Code B. The response times for Code A are 1 ms shorter than these values.

List of Models/Response Time/  
Current Consumption/Weight

# F3SG-SR/PG

## List of Models, Current Consumption and Weight

Model	Number of beams	Protective height [mm]	Current consumption [mA]		Weight [kg]	
			Emitter	Receiver	Net	Gross
F3SG-4SRA0160-25	8	160	63	105	0.4	1.2
F3SG-□SRB0160-25	8	160	61	96	0.4	1.2
F3SG-4SRA0200-25-F	10	200	65	108	0.5	1.3
F3SG-4SRB0200-25-F	10	200	62	96	0.5	1.3
F3SG-4SRA0240-25	12	240	68	110	0.6	1.4
F3SG-□SRB0240-25	12	240	63	97	0.6	1.4
F3SG-4SRA0280-25-F	14	280	71	112	0.7	1.5
F3SG-4SRB0280-25-F	14	280	64	97	0.7	1.5
F3SG-4SRA0320-25	16	320	74	115	0.8	1.6
F3SG-□SRB0320-25	16	320	65	97	0.8	1.6
F3SG-4SRA0360-25-F	18	360	76	117	0.9	1.8
F3SG-4SRB0360-25-F	18	360	65	98	0.9	1.8
F3SG-4SRA0400-25	20	400	79	119	1	1.9
F3SG-□SRB0400-25	20	400	66	98	1	1.9
F3SG-4SRA0440-25-F	22	440	82	121	1.1	2
F3SG-4SRB0440-25-F	22	440	67	98	1.1	2
F3SG-4SRA0480-25	24	480	84	124	1.2	2.1
F3SG-□SRB0480-25	24	480	68	99	1.2	2.1
F3SG-4SRA0520-25-F	26	520	87	126	1.3	2.2
F3SG-4SRB0520-25-F	26	520	69	99	1.3	2.2
F3SG-4SRA0560-25	28	560	90	128	1.4	2.3
F3SG-□SRB0560-25	28	560	70	99	1.4	2.3
F3SG-4SRA0600-25-F	30	600	92	131	1.5	2.5
F3SG-4SRB0600-25-F	30	600	71	100	1.5	2.5
F3SG-4SRA0640-25	32	640	95	133	1.6	2.6
F3SG-□SRB0640-25	32	640	72	100	1.6	2.6
F3SG-4SRA0680-25-F	34	680	98	135	1.7	2.7
F3SG-4SRB0680-25-F	34	680	73	100	1.7	2.7
F3SG-4SRA0720-25	36	720	100	137	1.8	2.8
F3SG-□SRB0720-25	36	720	74	101	1.8	2.8
F3SG-4SRA0760-25-F	38	760	103	140	1.9	2.9
F3SG-4SRB0760-25-F	38	760	75	101	1.9	2.9
F3SG-4SRA0800-25	40	800	106	142	2	3
F3SG-□SRB0800-25	40	800	76	101	2	3
F3SG-4SRA0840-25-F	42	840	109	144	2.1	3.1
F3SG-4SRB0840-25-F	42	840	77	101	2.1	3.1
F3SG-4SRA0880-25	44	880	111	147	2.2	3.2
F3SG-□SRB0880-25	44	880	78	102	2.2	3.2
F3SG-4SRA0920-25-F	46	920	114	149	2.3	3.4
F3SG-4SRB0920-25-F	46	920	79	102	2.3	3.4
F3SG-4SRA0960-25	48	960	117	151	2.4	3.5
F3SG-□SRB0960-25	48	960	80	102	2.4	3.5
F3SG-4SRA1000-25-F	50	1000	119	154	2.5	3.6
F3SG-4SRB1000-25-F	50	1000	81	103	2.5	3.6
F3SG-4SRA1040-25	52	1040	122	156	2.6	3.7
F3SG-□SRB1040-25	52	1040	82	103	2.6	3.7
F3SG-4SRA1120-25	56	1120	127	160	2.9	3.9
F3SG-□SRB1120-25	56	1120	84	104	2.9	3.9
F3SG-4SRA1200-25	60	1200	133	165	3.1	4.2
F3SG-□SRB1200-25	60	1200	86	104	3.1	4.2
F3SG-4SRA1280-25	64	1280	138	170	3.3	4.4
F3SG-□SRB1280-25	64	1280	88	105	3.3	4.4
F3SG-4SRA1360-25	68	1360	144	174	3.5	4.6
F3SG-□SRB1360-25	68	1360	90	106	3.5	4.6

Model	Number of beams	Protective height [mm]	Current consumption [mA]		Weight [kg]	
			Emitter	Receiver	Net	Gross
F3SG-4SRA1440-25	72	1440	149	179	3.7	4.8
F3SG-□SRB1440-25	72	1440	92	106	3.7	4.8
F3SG-4SRA1520-25	76	1520	154	183	3.9	5.3
F3SG-□SRB1520-25	76	1520	93	107	3.9	5.3
F3SG-4SRA1600-25	80	1600	160	188	4.1	5.5
F3SG-□SRB1600-25	80	1600	95	107	4.1	5.5
F3SG-4SRA1680-25	84	1680	165	192	4.3	5.8
F3SG-□SRB1680-25	84	1680	97	108	4.3	5.8
F3SG-4SRA1760-25	88	1760	170	197	4.5	6
F3SG-□SRB1760-25	88	1760	99	109	4.5	6
F3SG-4SRA1840-25	92	1840	176	202	4.7	6.2
F3SG-□SRB1840-25	92	1840	101	109	4.7	6.2
F3SG-4SRA1920-25	96	1920	181	206	4.9	6.4
F3SG-□SRB1920-25	96	1920	103	110	4.9	6.4
F3SG-4SRA2080-25	104	2080	192	215	5.3	6.9
F3SG-□SRB2080-25	104	2080	107	111	5.3	6.9
F3SG-4SRA2280-25	114	2280	205	227	5.8	7.5
F3SG-□SRB2280-25	114	2280	112	113	5.8	7.5
F3SG-4SRA2480-25	124	2480	219	238	6.3	8
F3SG-□SRB2480-25	124	2480	117	114	6.3	8

**Note:** 1. The net weight is the weight of an emitter and a receiver per set.

2. The gross weight is the weight of an emitter, a receiver, included accessories and a package.

## F3SG-SR/PG

### Arm/leg protection (Detection capability: 45-mm dia.)

#### List of Models and Response Times

Model		Number of beams	Protective height [mm]	Response time (Optical synchronization) [ms]			Response time (Wired synchronization) [ms]	
				ON to OFF	OFF (synchronized) to ON	OFF (not synchronized) to ON	ON to OFF	OFF to ON
F3SG-4SR□0240-45	F3SG-2SRB0240-45	6	240	8	40	140	10	50
F3SG-4SR□0400-45	F3SG-2SRB0400-45	10	400	8	40	140	10	50
F3SG-4SR□0560-45	F3SG-2SRB0560-45	14	560	8	40	140	10	50
F3SG-4SR□0720-45	F3SG-2SRB0720-45	18	720	8	40	140	10	50
F3SG-4SR□0880-45	F3SG-2SRB0880-45	22	880	8	40	140	10	50
F3SG-4SR□1200-45	F3SG-2SRB1200-45	30	1200	8	40	140	10	50
F3SG-4SR□1520-45	F3SG-2SRB1520-45	38	1520	8	40	140	10	50

Note: 1. The maximum speed of movement of a test rod up to which the detection capability is maintained is 2.0 m/s.

2. The response times of "Optical synchronization" are values when Scan Code is set at Code B. The response times for Code A are 1 ms shorter than these values.

#### List of Models, Current Consumption and Weight

Model	Number of beams	Protective height [mm]	Current consumption [mA]		Weight [kg]	
			Emitter	Receiver	Net	Gross
F3SG-4SRA0240-45	6	240	60	107	0.6	1.4
F3SG-□SRB0240-45	6	240	52	95	0.6	1.4
F3SG-4SRA0400-45	10	400	71	116	1	1.9
F3SG-□SRB0400-45	10	400	56	95	1	1.9
F3SG-4SRA0560-45	14	560	82	124	1.4	2.3
F3SG-□SRB0560-45	14	560	60	96	1.4	2.3
F3SG-4SRA0720-45	18	720	93	133	1.8	2.8
F3SG-□SRB0720-45	18	720	64	96	1.8	2.8
F3SG-4SRA0880-45	22	880	104	141	2.2	3.2
F3SG-□SRB0880-45	22	880	68	97	2.2	3.2
F3SG-4SRA1200-45	30	1200	125	158	3.1	4.2
F3SG-□SRB1200-45	30	1200	75	98	3.1	4.2
F3SG-4SRA1520-45	38	1520	147	175	3.9	5.3
F3SG-□SRB1520-45	38	1520	83	99	3.9	5.3

Note: 1. The net weight is the weight of an emitter and a receiver per set.

2. The gross weight is the weight of an emitter, a receiver, included accessories and a package.

## Body protection (Detection capability: 85-mm dia.)

## List of Models and Response Times

Model		Number of beams	Protective height [mm]	Response time (Optical synchronization) [ms]			Response time (Wired synchronization) [ms]	
				ON to OFF	OFF (synchronized) to ON	OFF (not synchronized) to ON	ON to OFF	OFF to ON
F3SG-4SR□0280-85	F3SG-2SRB0280-85	4	280	8	40	140	10	50
F3SG-4SR□0440-85	F3SG-2SRB0440-85	6	440	8	40	140	10	50
F3SG-4SR□0600-85	F3SG-2SRB0600-85	8	600	8	40	140	10	50
F3SG-4SR□0760-85	F3SG-2SRB0760-85	10	760	8	40	140	10	50
F3SG-4SR□0920-85	F3SG-2SRB0920-85	12	920	8	40	140	10	50

**Note:** 1. The maximum speed of movement of a test rod up to which the detection capability is maintained is 2.0 m/s.

2. The response times of "Optical synchronization" are values when Scan Code is set at Code B. The response times for Code A are 1 ms shorter than these values.

## List of Models, Current Consumption and Weight

Model	Number of beams	Protective height [mm]	Current consumption [mA]		Weight [kg]	
			Emitter	Receiver	Net	Gross
F3SG-4SRA0280-85	4	280	63	111	0.7	1.5
F3SG-□SRB0280-85	4	280	50	95	0.7	1.5
F3SG-4SRA0440-85	6	440	72	120	1.1	2
F3SG-□SRB0440-85	6	440	52	95	1.1	2
F3SG-4SRA0600-85	8	600	81	128	1.5	2.5
F3SG-□SRB0600-85	8	600	54	96	1.5	2.5
F3SG-4SRA0760-85	10	760	91	136	1.9	2.9
F3SG-□SRB0760-85	10	760	56	96	1.9	2.9
F3SG-4SRA0920-85	12	920	100	145	2.3	3.4
F3SG-□SRB0920-85	12	920	58	96	2.3	3.4

**Note:** 1. The net weight is the weight of an emitter and a receiver per set.

2. The gross weight is the weight of an emitter, a receiver, included accessories and a package.

## Legislation and Standards

- The F3SG-SR does not receive type approval provided by Article 44-2 of the Industrial Safety and Health Act of Japan. When using the F3SG-SR in Japan as a "safety system for pressing or shearing machines" prescribed in Article 42 of that law, the machine control system must receive type approval.
- The F3SG-SR is electro-sensitive protective equipment (ESPE) in accordance with European Union (EU) Machinery Directive Index Annex V, Item 2.

### 3. EU Declaration of Conformity

OMRON declares that the F3SG-SR is in conformity with the requirements of the following EU Directives:

Machinery Directive 2006/42/EC

EMC Directive 2014/30/EU

### 4. Conforming Standards

#### (1) European standards

EN61496-1 (Type 4 and Type 2 ESPE), EN 61496-2 (Type 4 and Type 2 AOPD), EN61508-1 through -4 (SIL 3 for Type 4 and SIL 1 for Type 2), EN ISO 13849-1:2015 (PL e, Category 4 for Type 4 and PL c, Category 2 for Type 2)

#### (2) International standards

IEC61496-1 (Type 4 and Type 2 ESPE), IEC61496-2 (Type 4 and Type 2 AOPD), IEC61508-1 through -4 (SIL 3 for Type 4 and SIL 1 for Type 2), ISO 13849-1:2015 (PL e, Category 4 for Type 4 and PL c, Category 2 for Type 2)

#### (3) JIS standards

JIS B 9704-1 (Type 4 and Type 2 ESPE), JIS B 9704-2 (Type 4 and Type 2 AOPD)

#### (4) North American standards

UL61496-1 (Type 4 and Type 2 ESPE), UL61496-2 (Type 4 and Type 2 AOPD), UL508, UL1998, CAN/CSA C22.2 No.14, CAN/CSA C22.2 No.0.8

#### (5) Chinese standards

GB/T 4584 (Specification of active opto-electronic protective devices for presses)

(Models: F3SG-4SR□□□□-14/-25 in the case of the ON to OFF response time not exceeding 20 ms max.)

The following configurations of the F3SG-SR are compliant with GB/T 4584.

Configurations using the F3SG-SR with detection capability of 14-mm or 25-mm dia. and 20 ms max. of the ON to OFF response time

Detection capability	Protective height	Number of beams	Configuration	Synchronization method	Response Time Adjustment	ON to OFF response time
14-mm dia.	160 to 2000 mm	-	Single	Optical	Normal	18 ms max.
14-mm dia.	160 to 1400 mm	-	Single	Wired	Normal	17 ms max.
25-mm dia.	160 to 2480 mm	-	Single	Optical/Wired	Normal	17 ms max.
Combination of 14-mm 25-mm dia. In cascade connection	-	255 max.	Cascaded	Optical	Normal	18 ms max. *
Combination of 14-mm 25-mm dia. In cascade connection	-	140 max.	Cascaded	Wired	Normal	15 ms max. *

\* Refer to *User's Manual* (Man.No.Z405) for more information on the response time for the F3SG-SR in cascade connection.

**Note:** The F3SG-SR's with detection capability of 45-mm and 85-mm dia. are not compliant with GB/T 4584. Refer to *Ratings and Specifications* on page 49 for more information on the ratings and specifications by model.

### 5. Third-Party Certifications

#### (1) TÜV SÜD

- EC Type-Examination certificate:

EU Machinery Directive, Type 4 and Type 2 ESPE (EN61496-1), Type 4 and Type 2 AOPD (EN 61496-2)

- Certificate:

Type 4 and Type 2 ESPE (EN61496-1), Type 4 and Type 2 AOPD (EN61496-2), EN 61508-1 through -4 (SIL 3 for Type 4 and SIL 1 for Type 2), EN ISO 13849-1:2015 (PL e, Category 4 for Type 4, and PL c, Category 2 for Type 2)

#### (2) UL

- UL Listing:

Type 4 and Type 2 ESPE (UL61496-1), Type 4 and Type 2 AOPD (UL61496-2), UL508, UL1998, CAN/CSA C22.2 No.14, CAN/CSA C22.2 No.0.8

#### (3) China National Casting and Forging Machines Quality Supervision and Inspection Center

- Certificate:

GB/T 4584 (Specification of active opto-electronic protective devices for presses)

(Models: F3SG-4SR□□□□-14/-25 in the case of the ON to OFF response time not exceeding 20 ms max.)

### 6. Other Standards

The F3SG-SR/PG is designed according to the standards listed below. To make sure that the final system complies with the following standards and regulations, you are asked to design and use it in accordance with all other related standards, laws, and regulations. If you have any questions, consult with specialized organizations such as the body responsible for prescribing and/or enforcing machinery safety regulations in the location where the equipment is to be used.

- European Standards: EN415-4, EN691-1, EN692, EN693, IEC 62046
- U.S. Occupational Safety and Health Standards: OSHA 29 CFR 1910.212
- U.S. Occupational Safety and Health Standards: OSHA 29 CFR 1910.217
- American National Standards: ANSI B11.1 to B11.19
- American National Standards: ANSI/RIA R15.06
- Canadian Standards Association CSA Z142, Z432, Z434
- SEMI Standards SEMI S2
- Japan Ministry of Health, Labour and Welfare "Guidelines for Comprehensive Safety Standards of Machinery", Standard Bureau's Notification No. 0731001 dated July 31, 2007.rms and Conditions Agreement
- Chinese National Standards: GB17120, GB27607

### 7. Meaning of mark according to EU WEEE Directive



Dispose in accordance with applicable regulations.

### 8. Regions where F39-SGBT can be used

The product can be used in Japan, the United States, Canada, and EU member state. The use in other countries may conflict with radio laws of the countries. For the regions where the F39-SGBT can be used, refer to the following instruction manuals of the F39-SGBT.

Document Title	No.
F39-SGBT Instruction Sheet	4615743-0
F39-SGBT Regulations and Standards	4615744-8

## Indicator

### LED Indicators on F3SG-SR

Shown below are indication statuses of the LED indicators on the F3SG-SR when you purchased.

#### Emitter (F3SG-SR)

Location	Indicator	Name	Color	Illuminated	Blinking	F3SG-SRA	F3SG-SRB
1	C or CODE	Scan code	Green	Code A is selected	---	X	X
			Orange	Code B is selected			
			OFF	Automatic interference prevention by wired synchronization being performed			
2	E or ERR	Lockout	Red	LOCKOUT state. The indicator is illuminated in the emitter of another sensor segment than that having a lockout error (when in cascade connection or between the emitter and receiver in the Wired Synchronization)	LOCKOUT state. The indicator is illuminated in the emitter of a sensor segment having a lockout error	X	X
3	L or LONG	Operating range	Green	Long Mode is selected	LOCKOUT state due to Operating range selection setting error	X	X
			OFF	Short Mode is selected	---		
4	T or TEST	Test	Yellow	---	External Test is being performed	X	X
5	---	Area Beam Indicator (ABI) (*1)	Green	The target beams of the ABI are unblocked and the safety outputs are turned ON	MUTING or OVERRIDE state. In the MUTING state, only the ABI indicators in the muting zone are blinking. Or the target beams of the ABI are blocked instantaneously	X	---
			Orange	Incident light level of the target beams of the ABI is 170% (factory default setting (*2)) or less of ON-threshold (for 5 to 10 s)	Incident light level of the target beams of the ABI is 170% (factory default setting (*2)) or less of ON threshold 5 to 10 s after illuminated when incident light level of the target beams of the ABI is 170% (factory default setting (*2)) or less of ON threshold. Or one muting input becomes the ON state and the MUTING state has not been started yet, or one muting input becomes the OFF state and the other is not in the OFF state yet. (*3)		
			Red	The target beams of the ABI are blocked	LOCKOUT state due to Cap error or Other sensor error (*4), or Lockout state due to DIP Switch setting error (*5 *6)		
			OFF	The target beams of the ABI are unblocked (The ABI then will be illuminated in green when the safety outputs are turned ON.)	---		
6	TOP	Top-beam-state (*1)	Blue	The top beam is unblocked	MUTING/OVERRIDE state, or LOCKOUT state due to Cap error or Other sensor error	---	X
7	BTM	Bottom-beam-state (*1)	Blue	The bottom beam is unblocked	MUTING/OVERRIDE, or LOCKOUT state due to DIP Switch setting error (*6)	---	X

\*1. The indicator of the emitter is illuminated only in the case the Wired Synchronization is enabled and is off in the case the Optical Synchronization is enabled.

\*2. Configurable by SD Manager 3.

\*3. This is the case for the Standard Muting mode. For other muting modes, refer to *User's Manual* (Man.No.Z405).

\*4. The Area Beam Indicator closer to the "TOP" mark on the F3SG-SR blinks.

\*5. The Area Beam Indicator closer to the "BTM" mark on the F3SG-SR blinks.

\*6. DIP switches is on the Intelligent Tap.

## Receiver (F3SG-SR)

Location	Indicator	Name	Color	Illuminated	Blinking	F3SG-SRA	F3SG-SRB
1	C or CODE	Scan code	Green	Code A is selected	---	X	X
			Orange	Code B is selected			
			OFF	Automatic interference prevention by wired synchronization being performed			
2	E or ERR	Lockout	Red	LOCKOUT state. The indicator is illuminated in the receiver of another sensor segment than that having a lockout error (when in cascade connection or between the emitter and receiver in the Wired Synchronization)	LOCKOUT state. The indicator is illuminated in the receiver of a sensor segment having a lockout error	X	X
			Green	Safety outputs are in ON state	---	X	X
3	O or OSSD	ON/OFF	Red	Safety outputs are in OFF state	LOCKOUT state due to Safety output error, or error due to abnormal power supply or noise	X	X
			Green	Safety outputs are in ON state	---	X	X
4	M or MAINT	Maintenance	Red	LOCKOUT state due to a recoverable error (When in cascade connection, the indicator of only the sensor segment having the error is illuminated)	LOCKOUT state due to a replacement-recommended error (When in cascade connection, the indicator of only the sensor segment having the error blinks)	X	X
			Orange	Safety outputs are instantaneously turned OFF due to ambient light, vibration or noise. Or sequence error in Muting, Pre-Reset or PSDI	Intelligent Tap is in the LOCKOUT state	X	X
5	P or PNP	PNP/NPN mode	Green	PNP is configured	Polarity of PNP is changed to NPN, or vice versa, during operation, and internal circuit is defective	X	X
			OFF	NPN is configured	---		
6	F or CFG	Configuration	Green	Fixed or Floating Blanking, Reduced Resolution, Warning Zone or Slow mode of Response Time Adjustment is enabled. Or after the Muting zone is determined by the Dynamic Muting function.	TEACH-IN mode, zone measurement being performed by Dynamic Muting, or LOCKOUT state due to Blanking monitoring error, Configuration error or Parameter error	X	X
			Yellow	INTERLOCK state	Sequence or sequence error in Muting, Pre-Reset or PSDI (*1) or Teach-in error		
8	---	Area Beam Indicator (ABI)	Green	The target beams of the ABI are unblocked and the safety outputs are turned ON	MUTING or OVERRIDE state. In the MUTING state, only the ABI indicators in the muting zone are blinking. Or the target beams of the ABI are blocked instantaneously	X	---
			Orange	Incident light level of the target beams of the ABI is 170% (factory default setting (*2)) or less of ON-threshold (for 5 to 10 s)	Incident light level of the target beams of the ABI is 170% (factory default setting (*2)) or less of ON threshold. Or one muting input becomes the ON state and the MUTING state has not been started yet, or one muting input becomes the OFF state and the other is not in the OFF state yet. (*3)		
			Red	The target beams of the ABI are blocked	LOCKOUT state due to Cap error or Other sensor error (*4), or LOCKOUT state due to DIP Switch setting error (*5*6)		
			OFF	The target beams of the ABI are unblocked (The ABI then will be illuminated in green when the safety outputs are turned ON.)	---		
9	TOP	Top-beam-state	Blue	The top beam is unblocked	MUTING/OVERRIDE state, or LOCKOUT state due to Cap error or Other sensor error	---	X
10	BTM	Bottom-beam-state	Blue	The bottom beam is unblocked	MUTING/OVERRIDE state, or LOCKOUT state due to DIP Switch setting error (*6)	---	X

\*1. Refer to *Troubleshooting* on page 95 for more information on blinking patterns.

\*2. Configurable by SD Manager 3.

\*3. This is the case for the Standard Muting mode. For other muting modes, refer to *User's Manual* (Man.No.Z405).

\*4. The Area Beam Indicator closer to the "TOP" mark on the F3SG-SR blinks.

\*5. The Area Beam Indicator closer to the "BTM" mark on the F3SG-SR blinks.

\*6. DIP switches is on the Intelligent Tap.

**Note:** In the SETTING state to make settings with the SD Manager 3, the TEST, LONG and CODE indicators on the emitter and the CFG, PNP and CODE indicators on the receiver blink. (TEST: Yellow, LONG/CODE: Green, CFG/PNP/CODE: Green)

For more information on the statuses of the LED indicators in the SETTING state, refer to *User's Manual* (Man.No.Z405).

## LED Indicators on Intelligent Tap

Shown below are indication statuses of LED indicators on the Intelligent Tap when you purchased.

Location	Indicator	Name	Color	Illuminated	Blinking
1	IN	Sensor status	Yellow	Safety outputs of the F3SG-SR are in the ON state	The F3SG-SR is in the LOCKOUT state. Or the Intelligent Tap is waiting for Push Switch operation (in the Backup) or the Intelligent Tap and F3SG-SR are waiting for restart (in the Backup). Or communication error in the Backup or between the F3SG-SR and the Intelligent Tap. Or the Restoration failed
2	OUT	Output status	Green	Outputs of the Intelligent Tap are in the ON state(*1)	The Restoration failed. Or in the Restoration, the Intelligent Tap has communication error, is waiting for Push Switch operation or transferring data, or the Intelligent Tap and F3SG-SR are waiting for restart.
			Red	Outputs of the Intelligent Tap are in the OFF state (*2)	Communication error between the F3SG-SR and the Intelligent Tap
3	IO-Link	IO-Link	Green	---	Intelligent Tap communicates with IO-Link Master. Or IO-Link circuit error
4	ERR	Lockout	Red	The Intelligent Tap is in the LOCKOUT state, or has communication error, DIP Switch circuit error at startup, communication error in the Backup or Restoration, restoration failure, IO-Link circuit error, power supply voltage error or other errors	---

\*1. When the safety outputs of the F3SG-SR are in the ON state, the outputs of the Intelligent Tap are in the ON state.

\*2. When the safety outputs of the F3SG-SR are in the OFF state, the outputs of the Intelligent Tap are in the OFF state.

**Note:** In the SETTING state to make settings with the SD Manager 3, the IN, OUT indicators blink. (IN: Yellow, OUT: Green)

For more information on the statuses of the LED indicators in the SETTING state, refer to User's Manual (Man.No.Z405).

# F3SG-SR/PG

## Connections (Basic Wiring Diagram)

### F3SG-SR

Examples of a motor control system using the F3SG-SR are shown below. The examples are equivalent to up to PLe, Category 4 (ISO 13849-1).

#### Non-Muting System Wiring Examples

##### Auto Reset Mode with Optical Synchronization and EDM Unused

[Wiring Example]

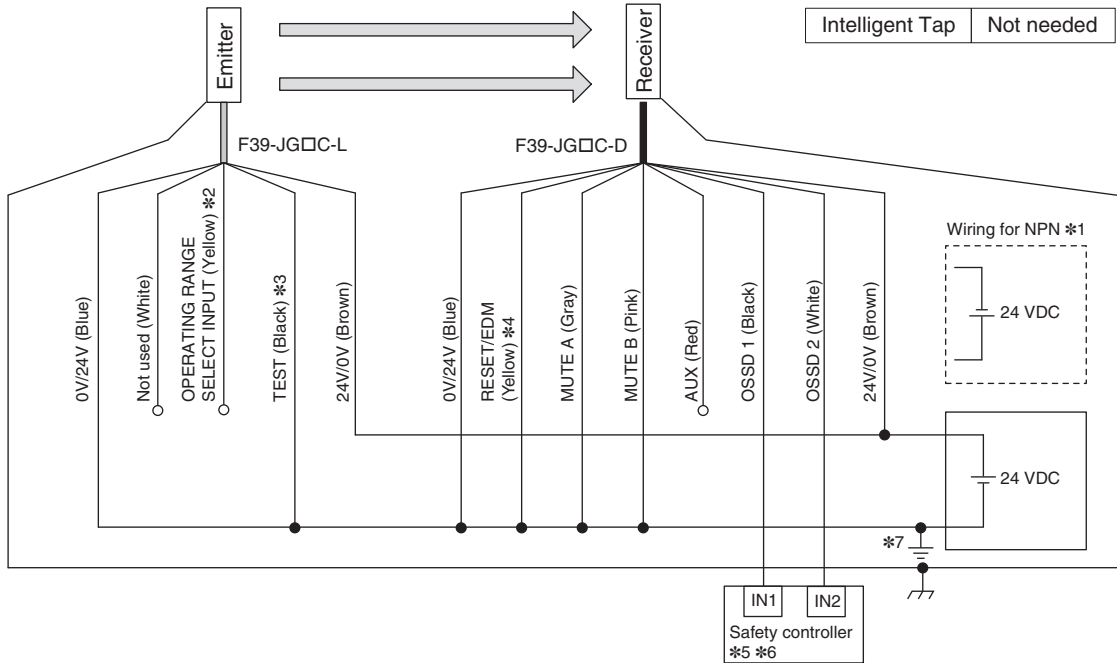

Function	Setting
EDM	EDM Disabled (factory default setting)
Interlock	Auto Reset (factory default setting)
Operating Range Selection	Long : Open the OPERATING RANGE SELECT INPUT line of the emitter or connect the line to 24 VDC.
Non-Muting system	Perform wiring according to the wiring diagram.
External Test not used	Connect the TEST line of the emitter to 0V/24V of the emitter.
Optical Synchronization	Do not connect the COM(+) and COM(-) lines of the of emitter and receiver with each other.

#### Timing chart

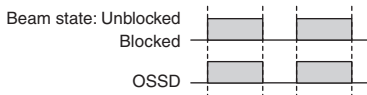

- \*1. Reverse the polarity of the power supply when using in the NPN system. Select a safety controller of PNP or NPN type according to the system of your application.
- \*2. Connect the line to 0 VDC if Operating Range Selection is used in Short Mode.
- \*3. If External Test is used, refer to the *User's Manual* (Man.No.Z405).
- \*4. Connect the line to 24V/0V (brown) of the receiver via a lockout reset switch (NC contact) if Lockout Reset is used.
- \*5. Refer to page 75 for more information.
- \*6. The safety controller and the F3SG-SR must share the power supply or be connected to the common terminal of the power supply.
- \*7. This is the case for a PELV circuit.

- Note:**
1. Functional earth connection to the F3SG-SR housing is unnecessary when you use the F3SG-SR in a general industrial environment where noise control or stable power supply is considered. However, when you use the F3SG-SR in an environment where there may be excessive noise from surroundings or stable power supply may be interfered, it is recommended the F3SG-SR be connected to functional earth.
  2. The wiring examples in later pages do not indicate functional earth. To use functional earth, wire an earth cable according to the example above. Refer to the *User's Manual* (Man.No.Z405) for more information.

**Auto Reset Mode with Wired Synchronization and EDM Unused**  
**[Wiring Example]**

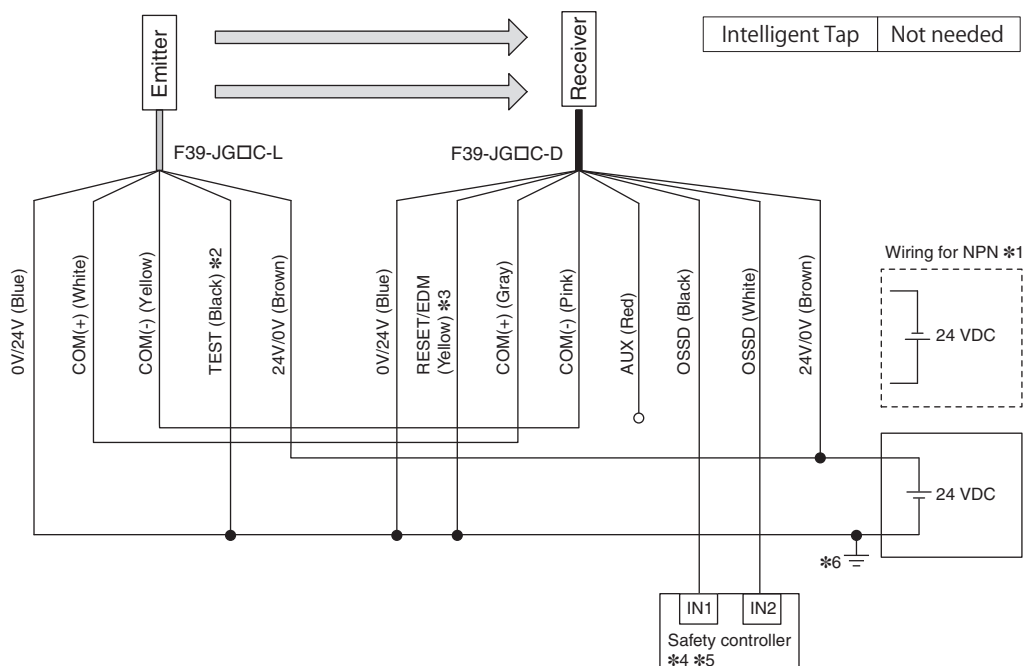

Function	Setting
EDM	EDM Disabled (factory default setting)
Interlock	Auto Reset (factory default setting)
Operating Range Selection	Long (factory default setting)
Non-Muting system	Perform wiring according to the wiring diagram.
External Test not used	Connect the TEST line of the emitter to 0V/24V of the emitter.
Optical Synchronization	Connect the COM(+) and COM(-) line of the emitter and receiver with each other.

Timing chart

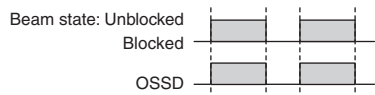

- \*1. Reverse the polarity of the power supply when using in the NPN system. Select a safety controller of PNP or NPN type according to the system of your application.
- \*2. If External Test is used, refer to the *User's Manual* (Man.No.Z405).
- \*3. Connect the line to 24V/0V (brown) of the receiver via a lockout reset switch (NC contact) if Lockout Reset is used.
- \*4. Refer to page 75 for more information.
- \*5. The safety controller and the F3SG-SR must share the power supply or be connected to the common terminal of the power supply.
- \*6. This is the case for a PELV circuit.

**Note:** For the functional earth connection, refer to page 66.

## Manual Reset Mode with EDM

### [Wiring Example]

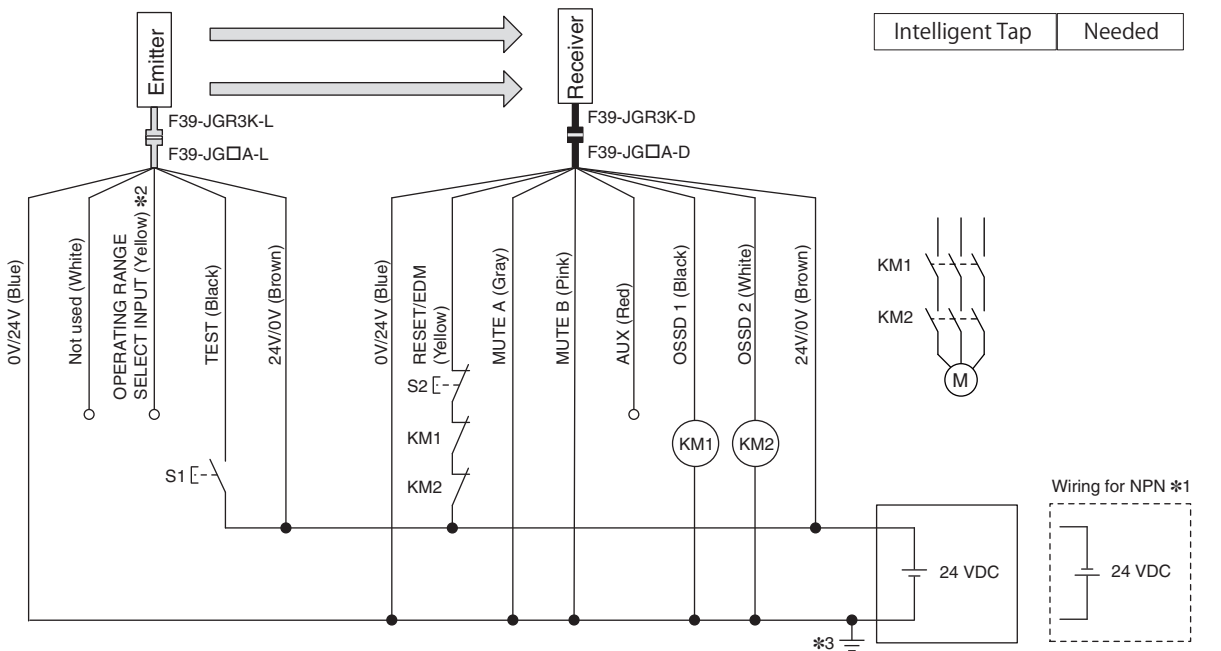

□ : Indicates a switch position.

Function	Setting	
	DIP switch	SD Manager 3
EDM #4	EDM Enabled 3 <input type="checkbox"/> ON	[External device monitoring] : Enable
Interlock #4	Manual Reset (Start/Restart Interlock) 4 <input type="checkbox"/> ON	[Start interlock] : Enable [Restart interlock] : Enable
	5 <input type="checkbox"/> ON	
Operating Range Selection	Long : Open the OPERATING RANGE SELECT INPUT line of the emitter or connect the line to 24 VDC.	
Non-Muting system	Perform wiring according to the wiring diagram.	
	N/A	[Muting] : Disable #4
External Test used	Connect the TEST line of the emitter to 24V/0V of the emitter via a test switch (NO contact).#5	
	N/A	[External test signal inversion] : Disable
Optical Synchronization	Do not connect the COM(+) and COM(-) lines of the of emitter and receiver with each other.	

#### Timing chart

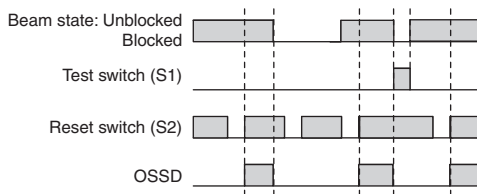

S1: Test switch

S2: Lockout/interlock reset switch

KM1, KM2: Safety relay with forcibly guided contacts (G7SA) or magnetic contactor  
M: Motor

\*1. Reverse the polarity of the power supply when using in the NPN system.  
\*2. Connect the line to 0 VDC if Operating Range Selection is used in Short Mode.

\*3. This is the case for a PELV circuit.

\*4. Set the function with the DIP Switches on the Intelligent Tap or the SD Manager 3, restore the settings to the F3SG-SR, and perform wiring according to the wiring diagram.

\*5. This wiring example shows light emission stop when connected to 24 VDC with PNP setting, and light emission stop when connected to 0 VDC with NPN setting. If TEST switch is not needed, refer to the *User's Manual* (Man. No. Z405).

**Note:** For the functional earth connection, refer to page 66.

Manual Reset Mode with EDM and Y-Joint Plug/Socket Connector

[Wiring Example]

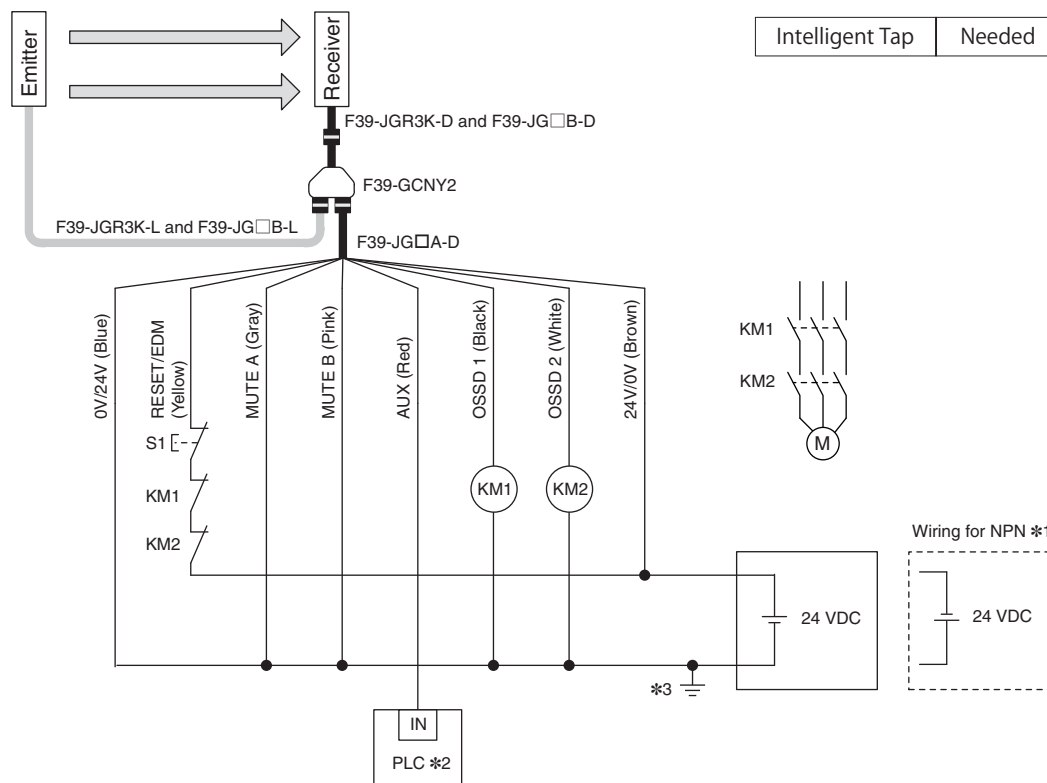

□ : Indicates a switch position.

Function	Setting	
	DIP switch	SD Manager 3
EDM *4	EDM Enabled    3 <input type="checkbox"/> ON	[External device monitoring] : Enable
Interlock *4	Manual Reset (Start/Restart Interlock)    4 <input type="checkbox"/> ON 5 <input type="checkbox"/> ON	[Start interlock] : Enable [Restart interlock] : Enable
Operating Range Selection	Long	
Non-Muting system	Perform wiring according to the wiring diagram.	
External Test not used	N/A	
Optical Synchronization	Connect the wires according to the diagram above.	

Timing chart

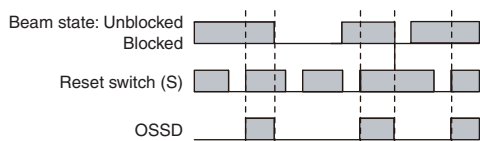

S1: Lockout/interlock reset switch  
 KM1, KM2: Safety relay with forcibly guided contacts (G7SA) or magnetic contactor  
 M: Motor  
 PLC: Programmable logic controller (Used for monitoring only. NOT related to safety system.)

- \*1. Reverse the polarity of the power supply when using in the NPN system. Select a PLC of PNP or NPN type according to the system of your application.
- \*2. When connecting to the PLC, the output mode must be changed with the SD Manager 3 according to your application. For the setting this function, refer to the *User's Manual* (Man.No.Z405).
- \*3. This is the case for a PELV circuit.
- \*4. Set the function with the DIP Switches on the Intelligent Tap or the SD Manager 3, restore the settings to the F3SG-SR, and perform wiring according to the wiring diagram.

**Note:** 1. When using the Y-Joint Plug/Socket Connector (F39-GCNY2), the following functions are not available.

- External Test
- Operating Range Selection by wiring
- Wired Synchronization

2. For the functional earth connection, refer to page 66.

Connections (Basic Wiring Diagram)

## Manual Reset Mode with Intelligent Tap [Wiring Example]

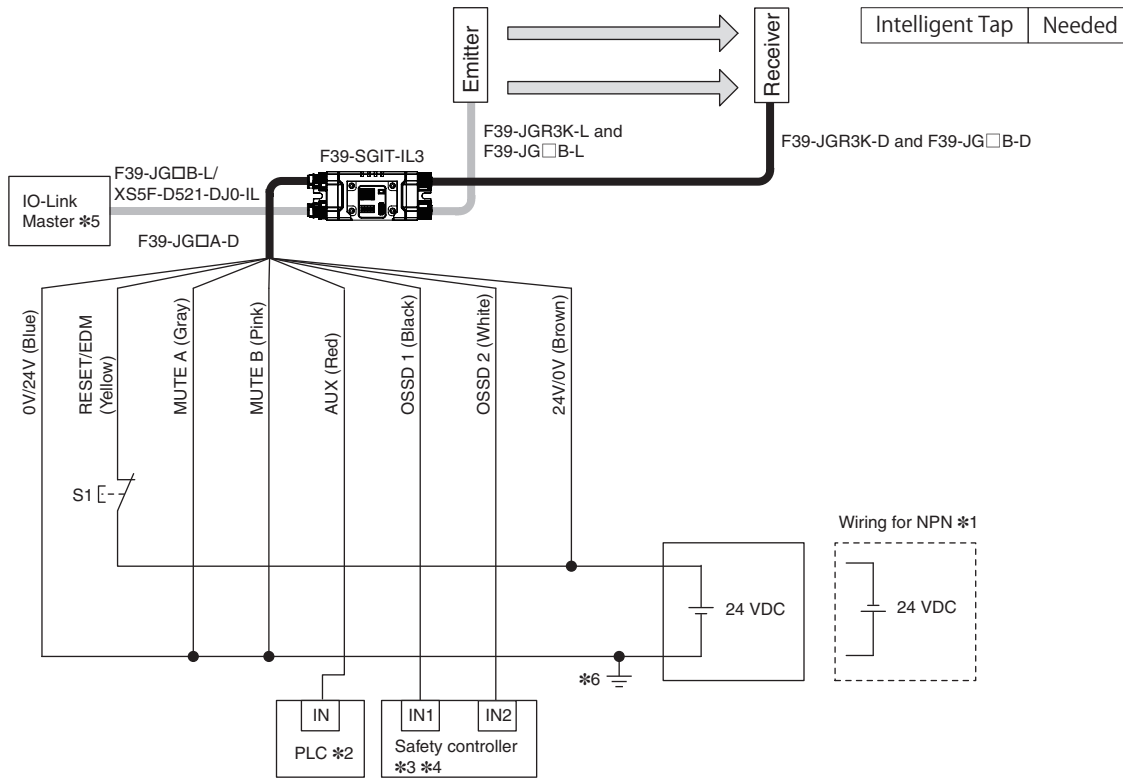

□ : Indicates a switch position.

Function	Setting		
	DIP switch		SD Manager 3
EDM	EDM Disabled	3 <input type="checkbox"/> ON	[External device monitoring] : Disable
Interlock *7	Manual Reset (Start/Restart Interlock)	4 <input type="checkbox"/> ON	[Start interlock] : Enable
		5 <input type="checkbox"/> ON	[Restart interlock] : Enable
Operating Range Selection *8	Long	8 <input type="checkbox"/> ON	[Operating Range Selection] : Long mode
Non-Muting system	Perform wiring according to the wiring diagram.		
	N/A		[Muting] : Disable *7
Test Input	N/A		
Wired Synchronization	Connect the emitter and receiver with the Intelligent Tap.		

### Timing chart

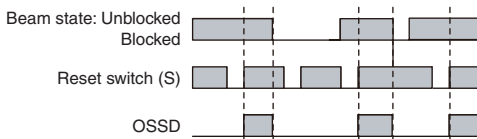

S1: Lockout/interlock reset switch

PLC: Programmable logic controller (Used for monitoring only. NOT related to safety system.)

- \*1. Reverse the polarity of the power supply when using in the NPN system. Select a PLC and a safety controller of PNP or NPN type according to the system of your application.
- \*2. When connecting to the PLC, the output mode must be changed with the SD Manager 3 according to your application. For the setting this function, refer to the *User's Manual* (Man.No.Z405).
- \*3. Refer to page 75 for more information.
- \*4. The safety controller and the F3SG-SR must share the power supply or be connected to the common terminal of the power supply.
- \*5. For connecting with the IO-Link Master unit, refer to an instruction manual of the IO-Link Master unit you use.
- \*6. This is the case for a PELV circuit.
- \*7. Set the function with the DIP Switches on the Intelligent Tap or the SD Manager 3, restore the settings to the F3SG-SR, and perform wiring according to the wiring diagram.
- \*8. To set the Short mode, set the function with the DIP Switches on the Intelligent Tap or the SD Manager 3, restore the settings to the F3SG-SR, and perform wiring according to the wiring diagram.

- Note:**
1. When using the Intelligent Tap (F39-SGIT-IL3) with the emitter and receiver connected, the following functions are not available.
    - External Test
    - Operating Range Selection by wiring
    - Optical Synchronization
  2. For the functional earth connection, refer to page 66.

Manual Reset Mode with Reset Switch Connector

[Wiring Example]

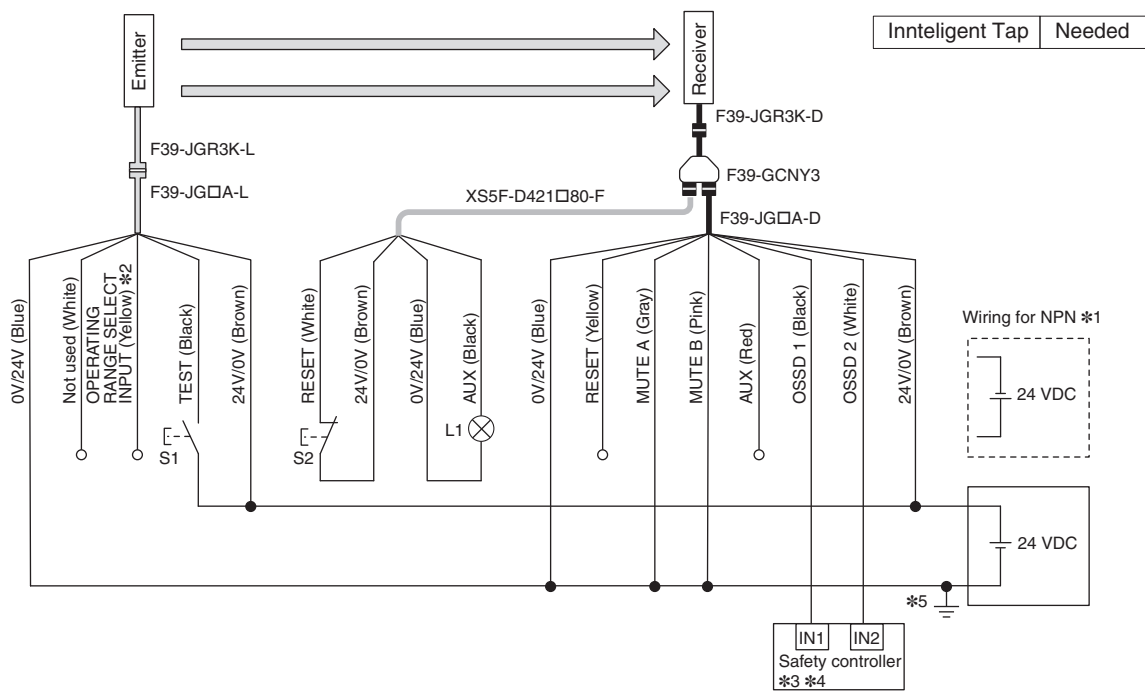

□ : Indicates a switch position.

Function	Setting	
	DIP switch	SD Manager 3
EDM	EDM Disabled (factory default setting)	[External device monitoring] : Disable
Interlock #6	Manual Reset (Start/Restart Interlock) 4 <input type="checkbox"/> ON 5 <input type="checkbox"/> ON	[Start interlock] : Enable [Restart interlock] : Enable
Operating Range Selection	Long : Open the OPERATING RANGE SELECT INPUT line of the emitter or connect the line to 24 VDC.	
Non-Muting system	Perform wiring according to the wiring diagram.	
	N/A	[Muting] : Disable #6
External Test used	Connect the TEST line of the emitter to 24V/0V of the emitter via a test switch (NO contact). *7	
	N/A	[External test signal inversion] : Disable
Optical Synchronization	Open the COM(+) and COM(-) lines of the emitter.	

Timing chart

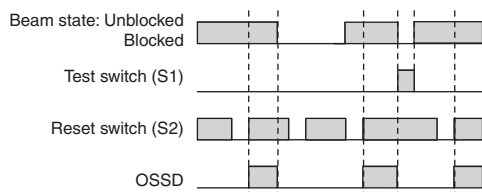

S1: Test switch  
S2: Lockout/interlock reset switch  
L1: Lamp

- \*1. Reverse the polarity of the power supply when using in the NPN system. Select a PLC and a safety controller of PNP or NPN type according to the system of your application.
- \*2. Connect the line to 0 VDC if Operating Range Selection is used in Short Mode.
- \*3. Refer to page 75 for more information.
- \*4. The safety controller and the F3SG-SR must share the power supply or be connected to the common terminal of the power supply.
- \*5. This is the case for a PELV circuit.
- \*6. Set the function with the DIP Switches on the Intelligent Tap or the SD Manager 3, restore the settings to the F3SG-SR, and perform wiring according to the wiring diagram.
- \*7. This wiring example shows light emission stop when connected to 24 VDC with PNP setting, and light emission stop when connected to 0 VDC with NPN setting. If TEST switch is not needed, refer to the *User's Manual* (Man. No. Z405).

- Note:**
1. When using the Reset Switch Connector (F39-GCNY3), the following functions are not available.
    - External Device Monitoring (EDM)
  2. For the functional earth connection, refer to page 66.

## Double Break with EDM [Wiring Example]

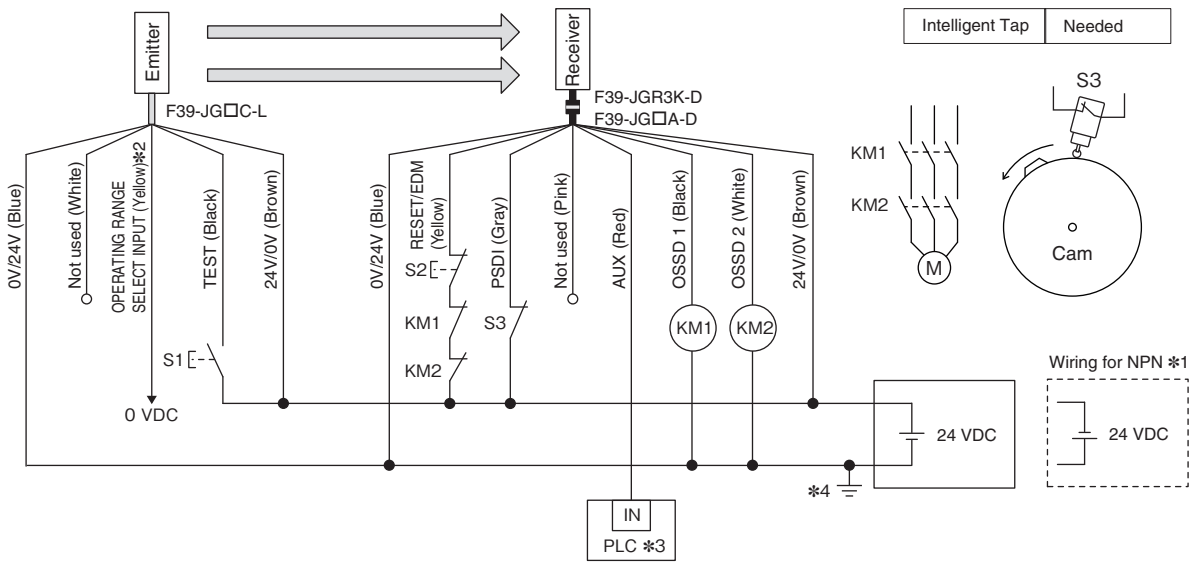

Function	Setting	
	DIP switch	SD Manager 3
EDM	-	[External device monitoring] : Enable *5
Operating Range Selection	Short : Connect the OPERATING RANGE SELECT INPUT line of the emitter to 0 VDC.	
PSDI	N/A	[PSDI] : Double break *5
Non-Muting system	Perform wiring according to the wiring diagram.	
	N/A	[Muting] : Disable *5
External Test used	Connect the TEST line of the emitter to 24V/0V of the emitter via a test switch (NO contact). *6	
	N/A	[External test signal inversion] : Disable
Optical Synchronization	Do not connect the COM(+) and COM(-) lines of the of emitter and receiver with each other.	

S1: Test switch  
 S2: Reset switch  
 S3: Press position switch  
 KM1, KM2: Safety relay with forcibly guided contacts (G7SA) or magnetic contactor  
 PLC: Programmable logic controller (Used for monitoring only. NOT related to safety system.)  
 M: Motor

- \*1. Reverse the polarity of the power supply when using in the NPN system. Select a PLC of PNP or NPN type according to the system of your application.
- \*2. Open or connect the line to 24 VDC if Operating Range Selection is used in Long Mode.
- \*3. When connecting to the PLC, the output mode must be changed with the SD Manager 3 according to your application. For the setting this function, refer to the *User's Manual* (Man.No.Z405).
- \*4. This is the case for a PELV circuit.
- \*5. Set the function with the SD Manager 3, restore the settings to the F3SG-SR, and perform wiring according to the wiring diagram.
- \*6. This wiring example shows light emission stop when connected to 24 VDC with PNP setting, and light emission stop when connected to 0 VDC with NPN setting. If TEST switch is not needed, refer to the *User's Manual* (Man. No. Z405).

### Timing chart

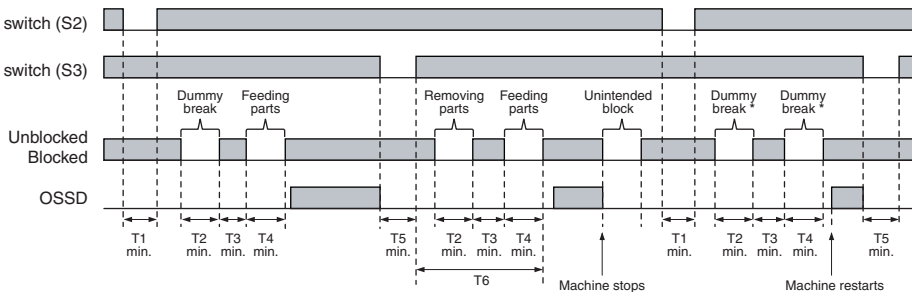

T1: Minimum pressing time of reset switch. Configurable from 100 to 500 ms in 100-ms increments by SD Manager 3.  
 T2: Minimum break time (300 ms)  
 T3: Minimum unblocked time during the time from removing to feeding parts. T3 = T1  
 T4: Minimum break time (300 ms)  
 T5: Minimum pressing time of press position switch. T5 = T1  
 T6: Wait time until double break is complete (30 s or less)

\* When the machine is stopped by unintended block in the middle of pressing of parts, operation of the reset switch (S1) and then double dummy break are needed for reinitiation of the machine cycle.

**Note:** For the functional earth connection, refer to page 66.

### Muting System Wiring Examples

#### Standard Muting Mode/Exit-Only Muting mode

[Wiring Example]

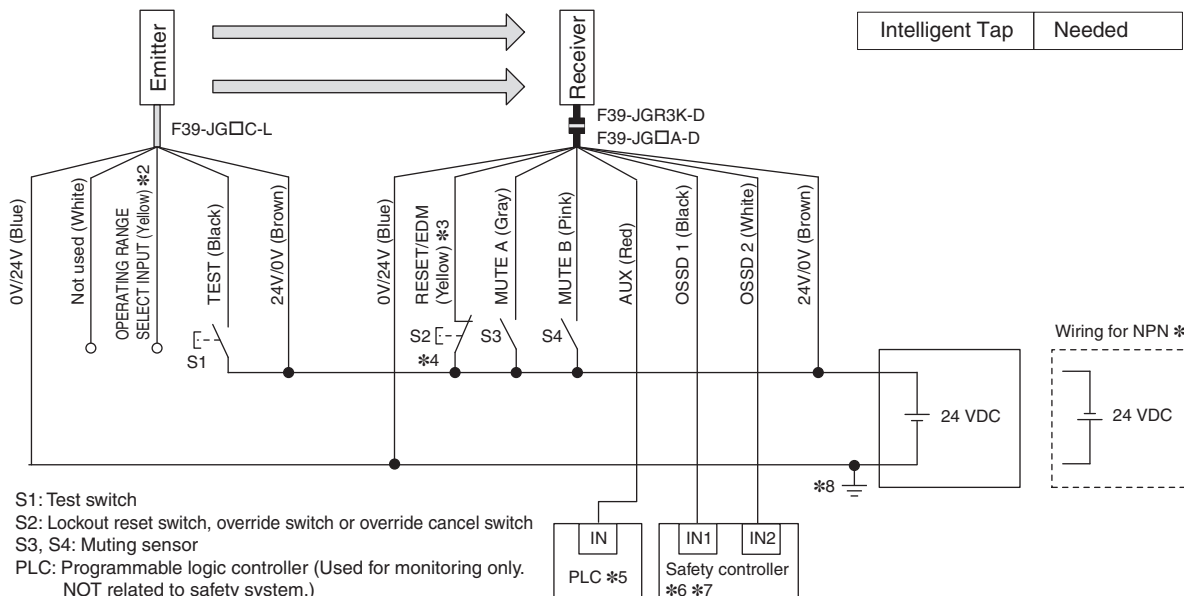

Function	Setting	
	DIP switch	SD Manager 3
EDM	EDM Disabled (factory default setting)	[External device monitoring] : Disable
Interlock	Auto Reset (factory default setting)	
	-	[Start interlock] : Disable [Restart interlock] : Disable
Operating Range Selection	Long : Open the OPERATING RANGE SELECT INPUT line of the emitter or connect the line to 24 VDC. When not using the Intelligent Tap or the SD Manager 3, perform wiring according to the wiring diagram. (factory default setting)	
Standard Muting Mode	N/A	[Muting] : Enable [Muting mode] : Standard Muting (Installation Example 1/2) *9
Exit-Only Muting Mode	N/A	[Muting] : Enable [Muting mode] : Exit-Only Muting *9
External Test used	Connect the TEST line of the emitter to 24V/0V of the emitter via a test switch (NO contact). *10	
	N/A	[External test signal inversion] : Disable
Optical Synchronization	Open the COM(+) and COM(-) lines of the emitter.	

#### Timing chart

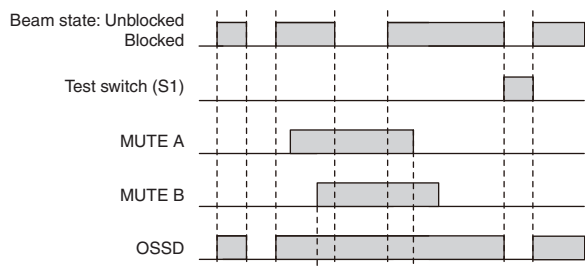

- \*1. Reverse the polarity of the power supply when using in the NPN system.
- \*2. Connect the line to 0 VDC if Operating Range Selection is used in Short Mode.
- \*3. Also used as OVERRIDE INPUT line.
- \*4. Make sure to connect an override cancel switch to the RESET line when using the override function. Otherwise the override state may not be released by the override cancel switch, resulting in serious injury.
- \*5. When connecting to the PLC, the output mode must be changed with the SD Manager 3 according to your application. For the setting this function, refer to the *User's Manual* (Man.No.Z405).
- \*6. Refer to page 75 for more information.
- \*7. The safety controller and the F3SG-SR must share the power supply or be connected to the common terminal of the power supply.
- \*8. This is the case for a PELV circuit.
- \*9. Set the function with the SD Manager 3, restore the settings to the F3SG-SR, and perform wiring according to the wiring diagram.
- \*10. This wiring example shows light emission stop when connected to 24 VDC with PNP setting, and light emission stop when connected to 0 VDC with NPN setting. If TEST switch is not needed, refer to the *User's Manual* (Man. No. Z405).

**Note:** For the functional earth connection, refer to page 66.

## Standard Muting Mode/Exit-Only Muting mode with Intelligent Tap

[Wiring Example]

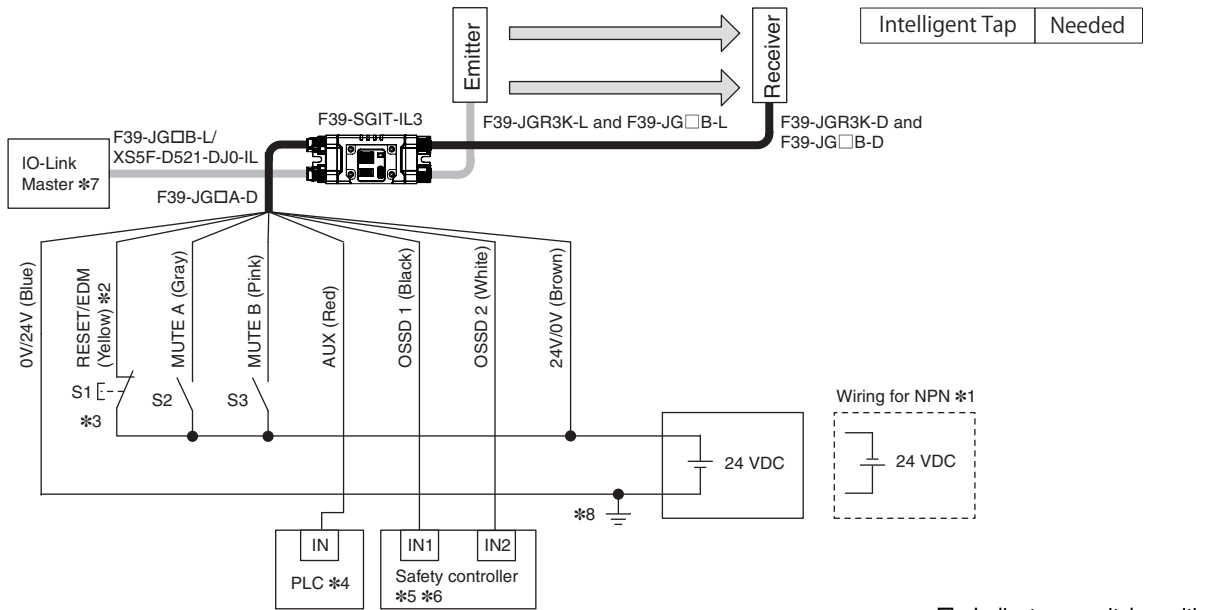

□ : Indicates a switch position.

Function	Setting	
	DIP switch	SD Manager 3
EDM	EDM Disabled 3 <input type="checkbox"/> ON	[External device monitoring] : Disable
Interlock	Auto Reset 4 <input type="checkbox"/> ON	[Start interlock] : Disable
	5 <input type="checkbox"/> ON	[Restart interlock] : Disable
Operating Range Selection #9	Long 8 <input type="checkbox"/> ON	[Operating Range Selection] : Long mode
Standard Muting Mode	N/A	[Muting] : Enable [Muting mode] : Standard Muting (Installation Example1/2) #10
Exit-Only Muting Mode	N/A	[Muting] : Enable [Muting mode] : Exit-Only Muting #10
Test Input	N/A	
Wired Synchronization	Connect the emitter and receiver with the Intelligent Tap.	

### Timing chart

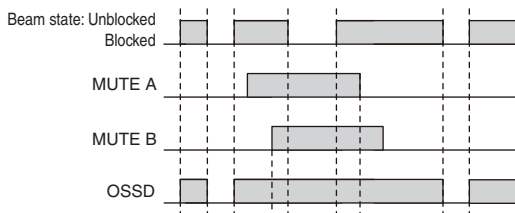

S1: Lockout reset switch, override switch or override cancel switch

S2, S3: Muting sensor

PLC: Programmable logic controller (Used for monitoring only. NOT related to safety system.)

- \*1. Reverse the polarity of the power supply when using in the NPN system. Select a PLC and a safety controller of PNP or NPN type according to the system of your application.
- \*2. Also used as OVERRIDE INPUT line.
- \*3. Make sure to connect an override cancel switch to the RESET line when using the override function. Otherwise the override state may not be released by the override cancel switch, resulting in serious injury.
- \*4. When connecting to the PLC, the output mode must be changed with the SD Manager 3 according to your application. For the setting this function, refer to the *User's Manual* (Man.No.Z405).
- \*5. Refer to page 75 for more information.
- \*6. The safety controller and the F3SG-SR must share the power supply or be connected to the common terminal of the power supply.
- \*7. For connecting with the IO-Link Master unit, refer to an instruction manual of the IO-Link Master unit you use.
- \*8. This is the case for a PELV circuit.
- \*9. To set the Short mode, set the function with the DIP Switches on the Intelligent Tap or the SD Manager 3, restore the settings to the F3SG-SR, and perform wiring according to the wiring diagram.
- \*10. Set the function with the SD Manager 3, restore the settings to the F3SG-SR, and perform wiring according to the wiring diagram.

**Note:** 1. When using the Intelligent Tap (F39-SGIT-IL3), the following functions are not available.

- External Test
- Operating Range Selection by wiring
- Optical Synchronization

2. For the functional earth connection, refer to page 66.

## Connectable Safety Control Units

The F3SG-SR in the PNP system can be connected to the safety control units listed in the table below.

Connectable safety control units (PNP output)		
G9SA-301	G9SX-AD322-T	G9SP-N10S
G9SA-321-T□	G9SX-ADA222-T	G9SP-N10D
G9SA-501	G9SX-BC202	G9SP-N20S
G9SB-200-B	G9SX-GS226-T15	NE0A-SCPU01
G9SB-200-D		NE1A-SCPU01
G9SB-301-B		NE1A-SCPU02
G9SB-301-D		DST1-ID12SL-1
G9SE-201		DST1-MD16SL-1
G9SE-401		DST1-MRD08SL-1
G9SE-221-T□		NX-SIH400
F3SP-T01		NX-SID800
		GI-SMD1624
		GI-SID1224

The F3SG-SR in the NPN system can be connected to the safety control unit listed in the table below.

Connectable safety control units (NPN output)
G9SA-301-P

For the connection to IO-Link with the Intelligent Tap, the F3SG-SR can be connected to the IO-Link Master unit listed in the table below.

Connectable IO-Link Master units *
NX-ILM400
GX-ILM08C

\* Connectable to units supporting IO-Link Version 1.1.

# F3SG-SR/PG

## Input/Output Circuit

### Entire Circuit Diagram

The entire circuit diagrams of the F3SG-SR are shown below.  
The numbers in the circles indicate the connector's pin numbers.

#### F3SG-SR

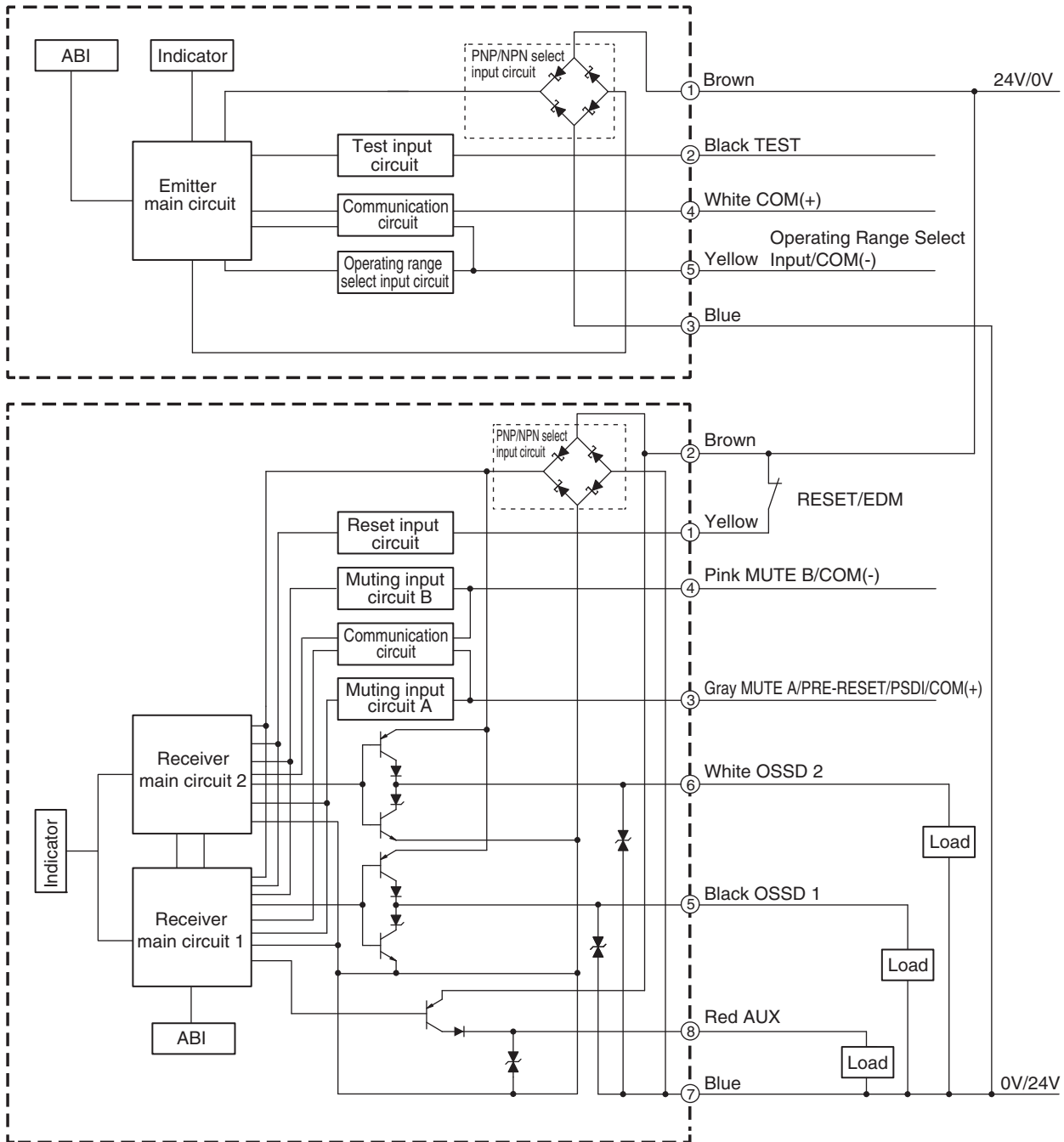

## Input Circuit Diagram by Function

The input circuit diagrams of by function are shown below.

### Test Input

<Light emission stops when connected to 24 VDC>

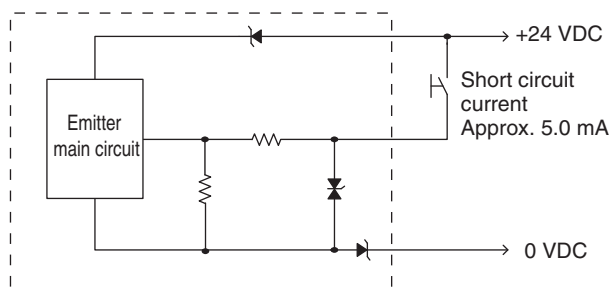

<Light emission stops when connected to 0 V>

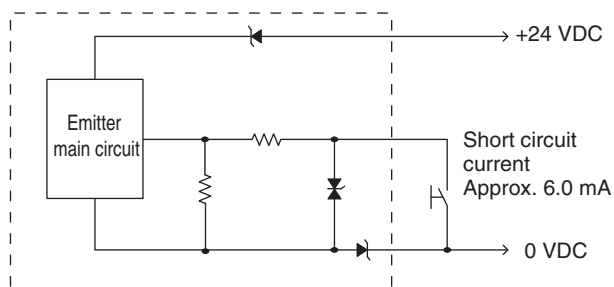

### Operating Range Select Input

<Long>

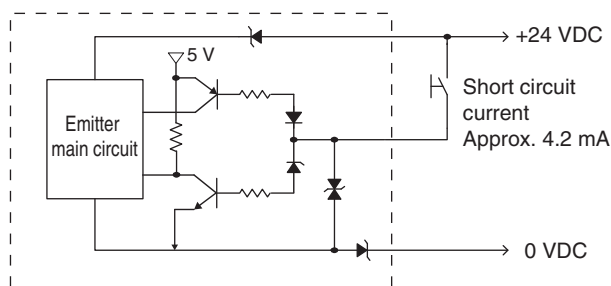

<Short>

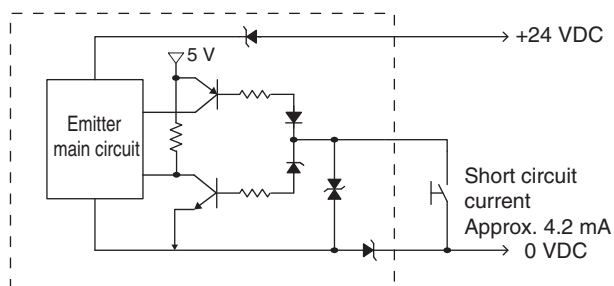

### RESET/EDM, MUTE A/B

<PNP>

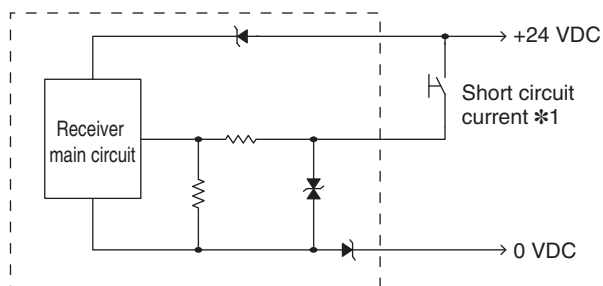

<NPN>

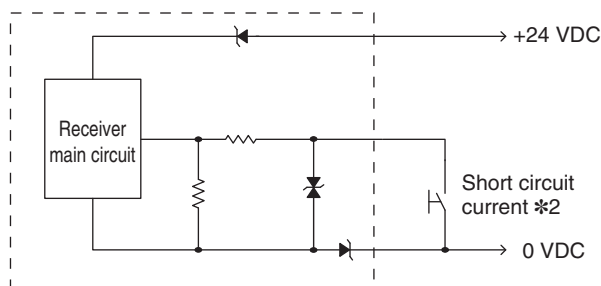

\*1. Short circuit current: approx. 9.5 mA (RESET/EDM), approx. 4.5 mA (MUTE A/B)

\*2. Short circuit current: approx. 13.0 mA (RESET/EDM), approx. 7.0 mA (MUTE A/B)

### F3SG-SR Series

#### Mounted with Side-Mount Brackets (Intermediate Brackets) (F39-LSGF) Backside Mounting

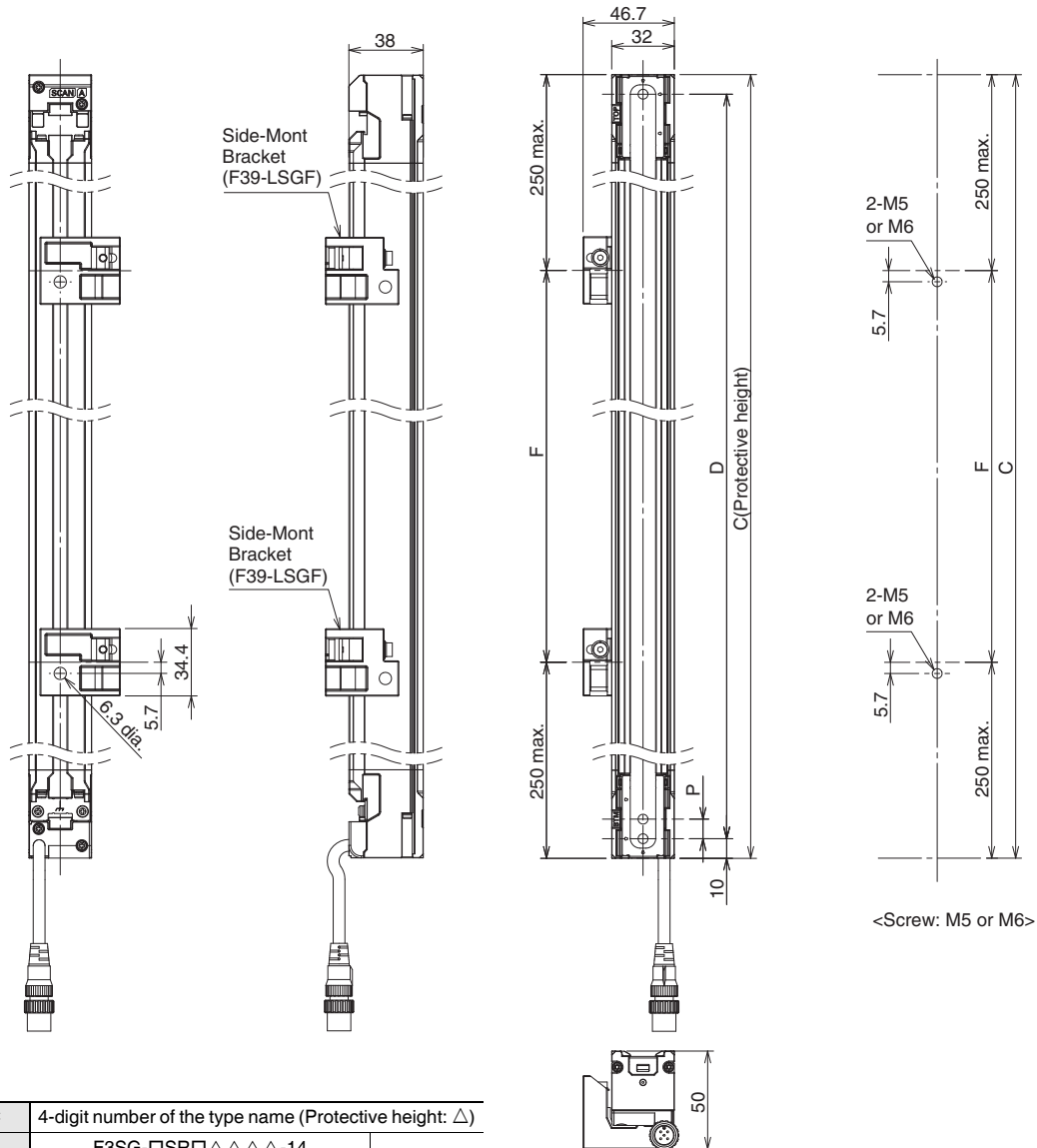

Dimension C	4-digit number of the type name (Protective height: $\Delta$ )	
Dimension D	F3SG-□SR□△△△△△-14	C-20
	F3SG-□SR□△△△△△-25	
	F3SG-□SR□△△△△△-45	C-40
	F3SG-□SR□△△△△△-85	
Dimension P	F3SG-□SR□△△△△△-14	10
	F3SG-□SR□△△△△△-25	20
	F3SG-□SR□△△△△△-45	40
	F3SG-□SR□△△△△△-85	80

Protective height (Dimension C)	Number of Side-Mount Bracket *	Dimension F
0160 to 1440	2	1000 mm max.
1520 to 2480	3	1000 mm max.

\* The number of brackets required to mount either one of emitter and receiver. The side-mount brackets (intermediate brackets) are included with the light curtain.

Side Mounting

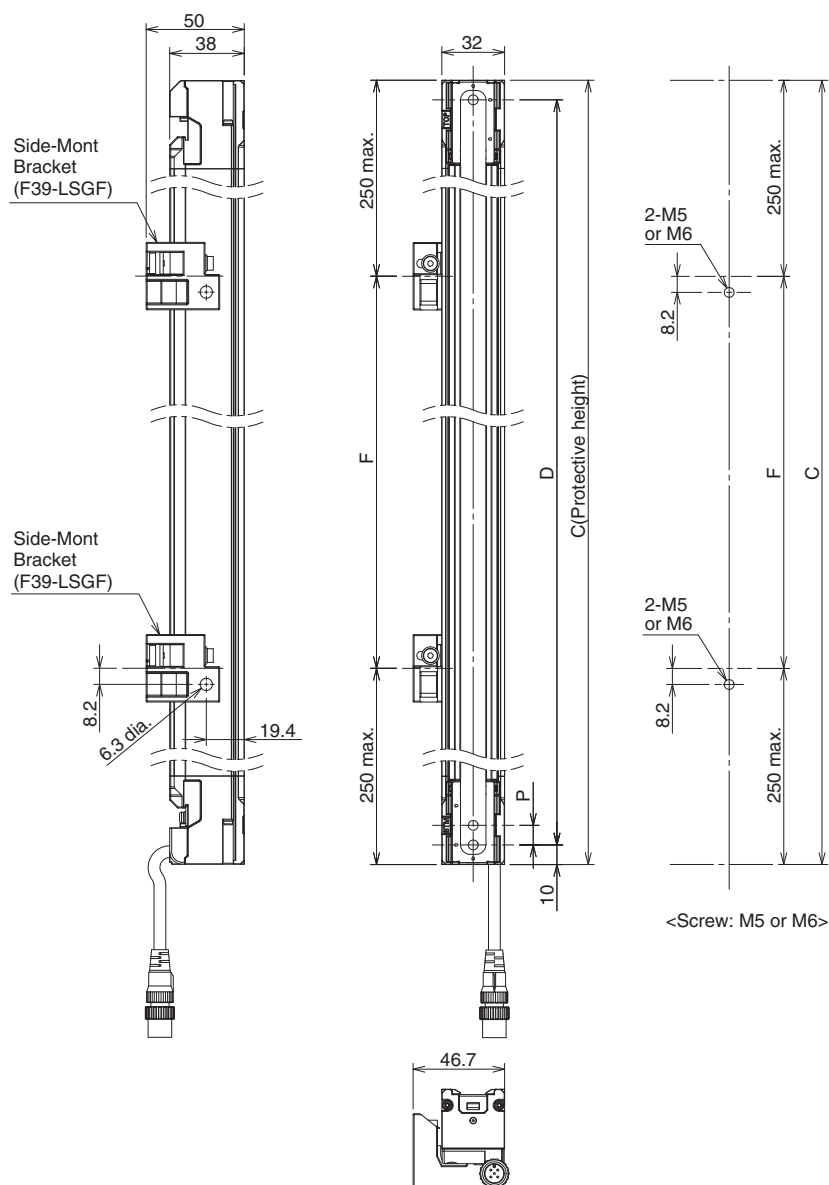

<b>Dimension C</b>	4-digit number of the type name (Protective height: △)	
<b>Dimension D</b>	F3SG-□SR□△△△△-14	C-20
	F3SG-□SR□△△△△-25	
	F3SG-□SR□△△△△-45	C-40
	F3SG-□SR□△△△△-85	
<b>Dimension P</b>	F3SG-□SR□△△△△-14	10
	F3SG-□SR□△△△△-25	20
	F3SG-□SR□△△△△-45	40
	F3SG-□SR□△△△△-85	80

Protective height (Dimension C)	Number of Side-Mount Bracket *	Dimension F
0160 to 1440	2	1000 mm max.
1520 to 2480	3	1000 mm max.

\* The number of brackets required to mount either one of emitter and receiver. The side-mount brackets (intermediate brackets) are included with the light curtain.

Dimensions

## Mounted with Adjustable Side-Mount Brackets (Intermediate Brackets) (F39-LSGA) Backside Mounting

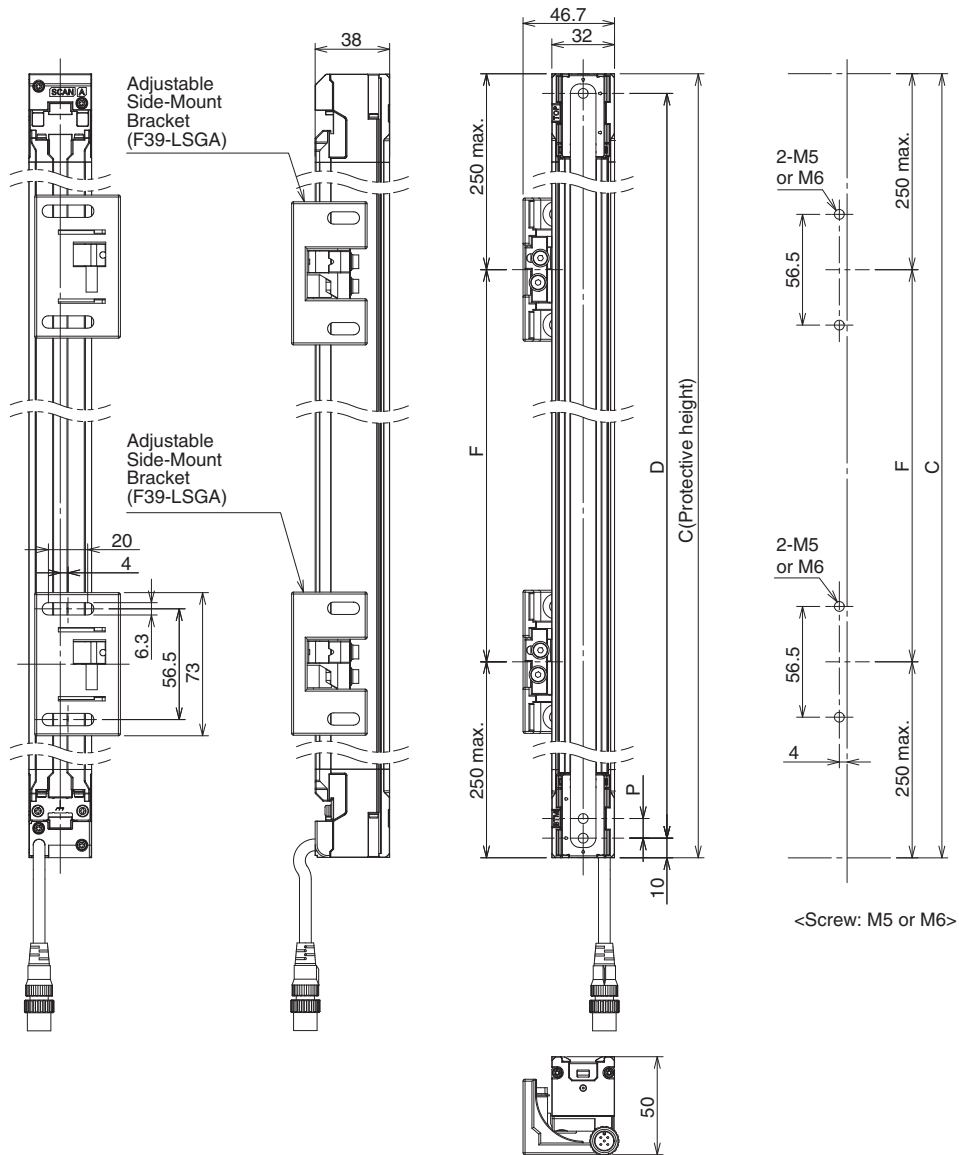

Dimension C	4-digit number of the type name (Protective height: $\Delta$ )	
Dimension D	F3SG-□SR□△△△△-14	C-20
	F3SG-□SR□△△△△-25	
	F3SG-□SR□△△△△-45	C-40
	F3SG-□SR□△△△△-85	
Dimension P	F3SG-□SR□△△△△-14	10
	F3SG-□SR□△△△△-25	20
	F3SG-□SR□△△△△-45	40
	F3SG-□SR□△△△△-85	80

Protective height (Dimension C)	Number of Adjustable Side-Mount Bracket *	Dimension F
0160 to 0280	1	1000 mm max.
0320 to 1440	2	1000 mm max.
1520 to 2480	3	1000 mm max.

\* The number of brackets required to mount either one of emitter and receiver.

Side Mounting

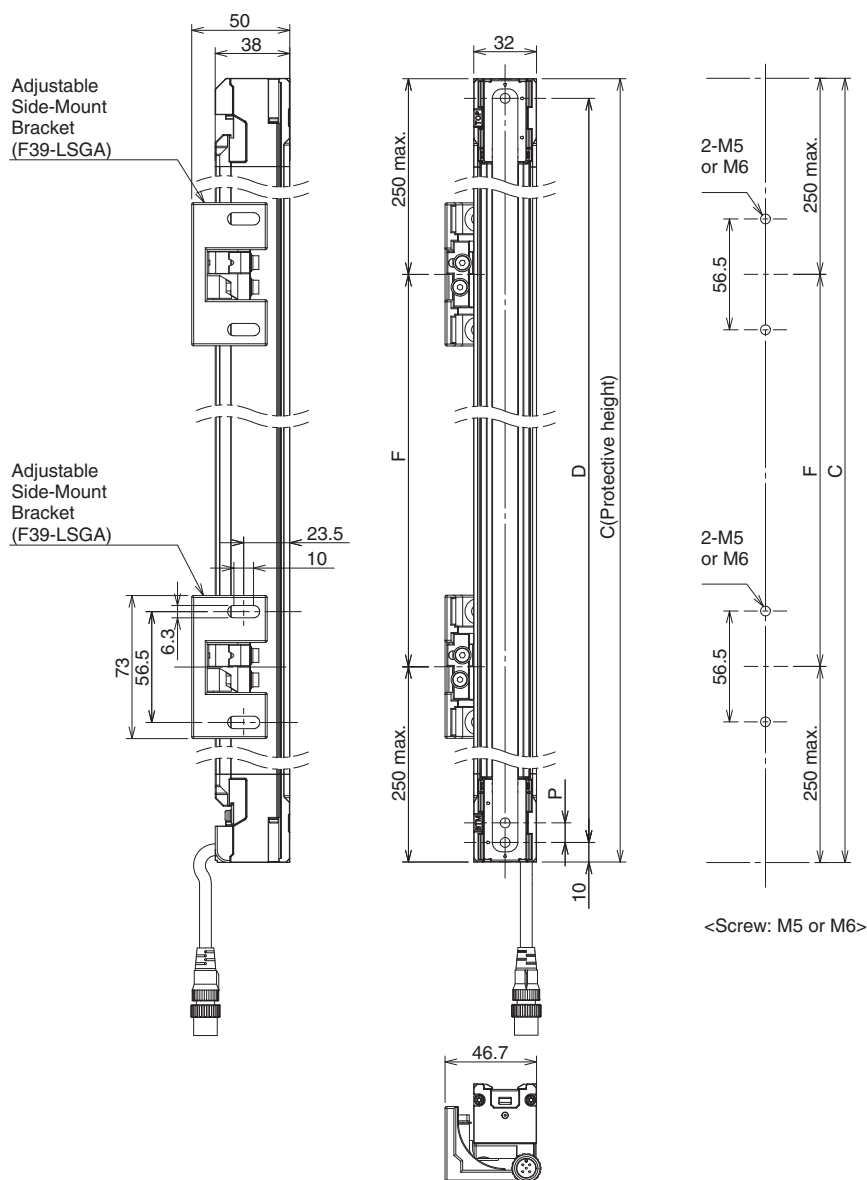

Dimension C	4-digit number of the type name (Protective height: $\Delta$ )		Protective height (Dimension C)	Number of Adjustable Side-Mount Bracket *	Dimension F							
Dimension D	F3SG-□SR□△△△△-14	C-20				0160 to 0280	1	1000 mm max.				
	F3SG-□SR□△△△△-25											
	F3SG-□SR□△△△△-45	C-40										
F3SG-□SR□△△△△-85	10		0320 to 1440	2	1000 mm max.							
Dimension P									F3SG-□SR□△△△△-14	20	1520 to 2480	3
		F3SG-□SR□△△△△-25										
	F3SG-□SR□△△△△-45											
	F3SG-□SR□△△△△-85	80										

\* The number of brackets required to mount either one of emitter and receiver.

Dimensions

# F3SG-SR/PG

## Mounted with Adjustable Top/Bottom Brackets (F3SJ, F3SN Adapter) (F39-LSGTB-SJ) and Side-Mount Brackets (Intermediate Brackets) (F39-LSGF) Backside Mounting

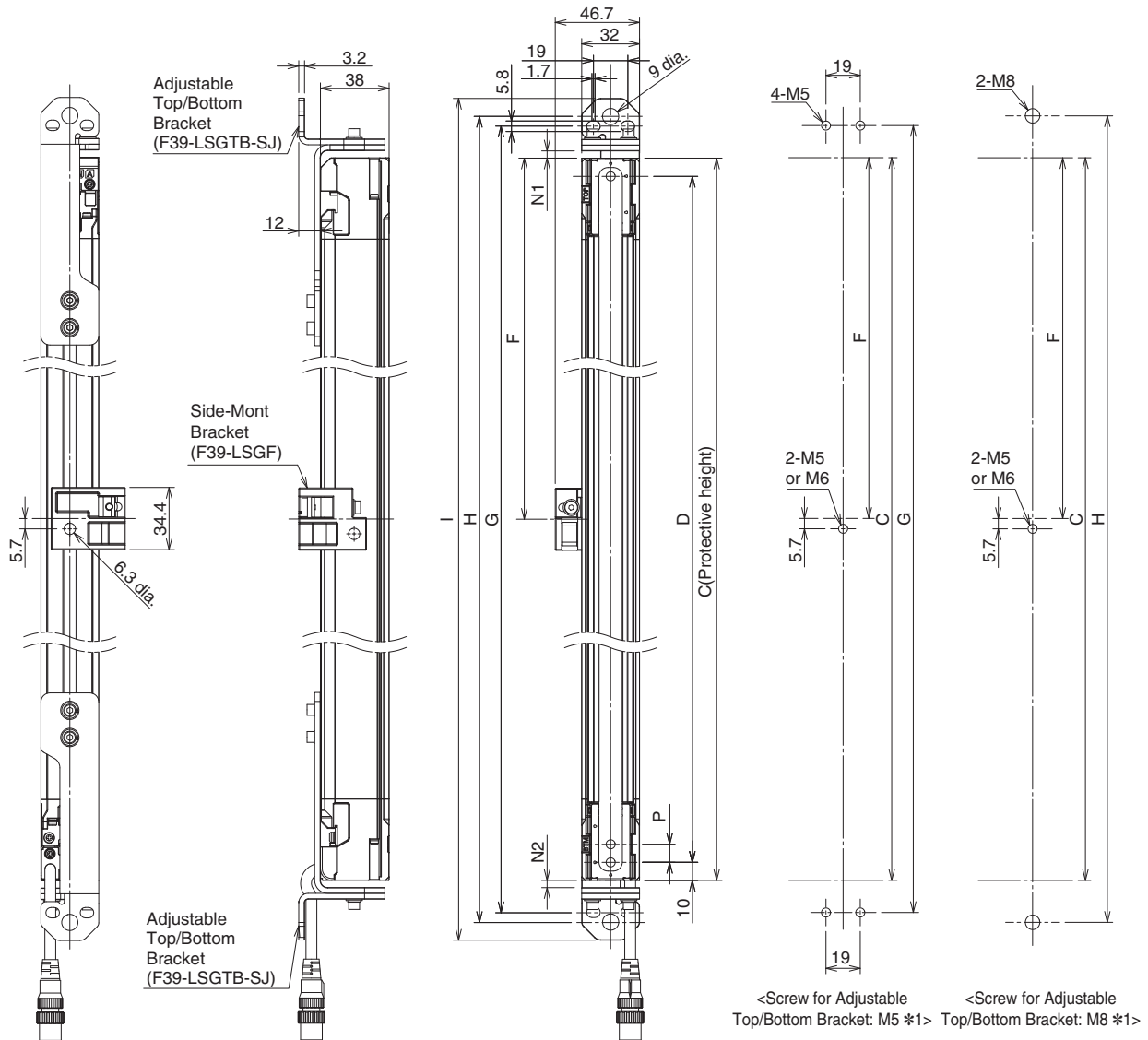

<b>Dimension C</b>	4-digit number of the type name (Protective height: $\Delta$ )	
<b>Dimension D</b>	F3SG-□SR□△△△△-14	C-20
	F3SG-□SR□△△△△-25	
	F3SG-□SR□△△△△-45	C-40
	F3SG-□SR□△△△△-85	
<b>Dimension G</b>	$C+27.2+N1+N2$	
<b>Dimension H</b>	$C+38+N1+N2$	
<b>Dimension I</b>	$C+58+N1+N2$	
<b>Dimension N1</b>	0 to 30 *2	
<b>Dimension N2</b>	0 to 30 *2	
<b>Dimension P</b>	F3SG-□SR□△△△△-14	10
	F3SG-□SR□△△△△-25	20
	F3SG-□SR□△△△△-45	40
	F3SG-□SR□△△△△-85	80

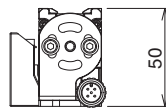

Protective height (Dimension C)	Number of Adjustable Top/Bottom Bracket *3	Number of Intermediate Bracket *3*4	Dimension F
0160 to 0840	2	0	---
0880 to 1680	2	1	1000 mm max.
1760 to 2480	2	2	1000 mm max.

\*1. Side-Mount Bracket: M5 or M6

\*2. For the model of protective height of 0160, the numbers corresponding to dimensions N1 and N2 are 20 to 30.

\*3. The number of brackets required to mount either one of emitter and receiver.

\*4. The side-mount brackets (intermediate brackets) are included with the light curtain.

Side Mounting

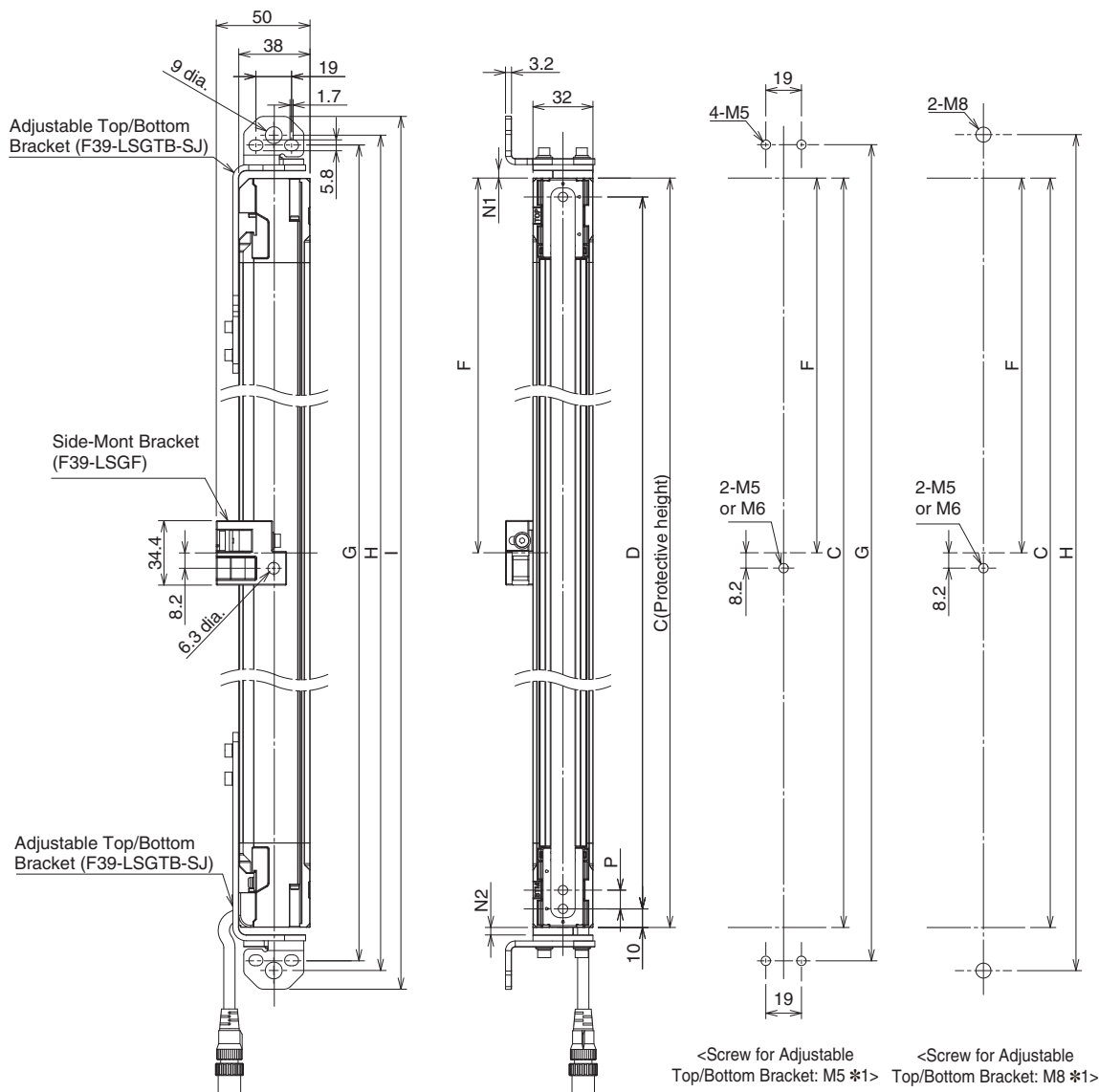

<Screw for Adjustable Top/Bottom Bracket: M5 \*1> <Screw for Adjustable Top/Bottom Bracket: M8 \*1>

<b>Dimension C</b>	4-digit number of the type name (Protective height: $\Delta$ )	
<b>Dimension D</b>	F3SG-□SR□△△△△-14	C-20
	F3SG-□SR□△△△△-25	
	F3SG-□SR□△△△△-45	C-40
	F3SG-□SR□△△△△-85	
<b>Dimension G</b>	$C+27.2+N1+N2$	
<b>Dimension H</b>	$C+38+N1+N2$	
<b>Dimension I</b>	$C+58+N1+N2$	
<b>Dimension N1</b>	0 to 30 *2	
<b>Dimension N2</b>	0 to 30 *2	
<b>Dimension P</b>	F3SG-□SR□△△△△-14	10
	F3SG-□SR□△△△△-25	20
	F3SG-□SR□△△△△-45	40
	F3SG-□SR□△△△△-85	80

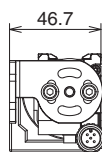

Protective height (Dimension C)	Number of Adjustable Top/Bottom Bracket *3	Number of Intermediate Bracket *3*4	Dimension F
0160 to 0840	2	0	---
0880 to 1680	2	1	1000 mm max.
1760 to 2480	2	2	1000 mm max.

- \*1. Side-Mount Bracket: M5 or M6
- \*2. For the model of protective height of 0160, the numbers corresponding to dimensions N1 and N2 are 20 to 30.
- \*3. The number of brackets required to mount either one of emitter and receiver.
- \*4. The side-mount brackets (intermediate brackets) are included with the light curtain.

Dimensions

# F3SG-SR/PG

## Mounted with Adjustable Top/Bottom Brackets (F3SJ, F3SN Adapter) (F39-LSGTB-SJ) and Adjustable Side-Mount Brackets (Intermediate Brackets) (F39-LSGA) Backside Mounting

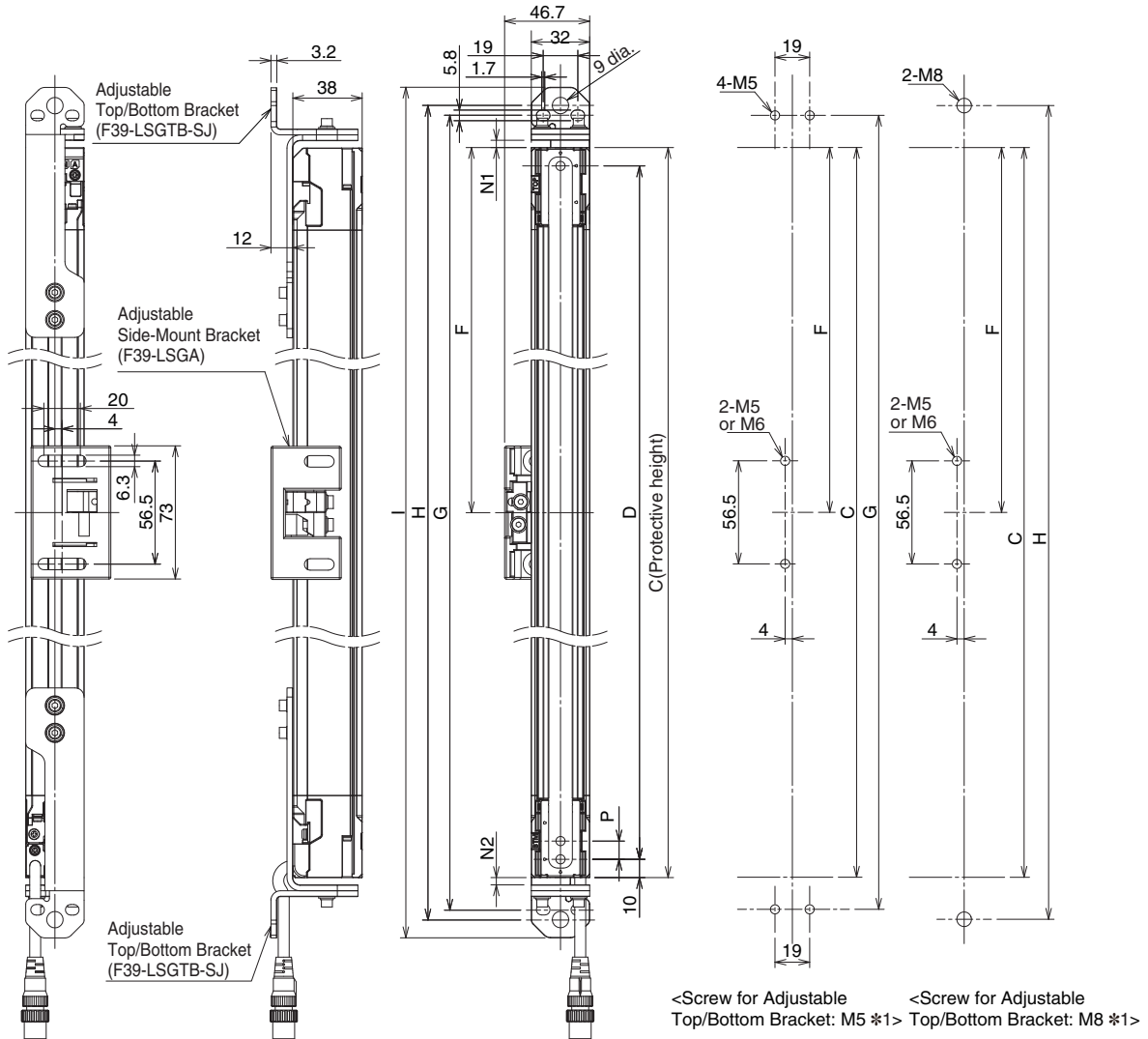

<b>Dimension C</b>	4-digit number of the type name (Protective height: $\Delta$ )	
<b>Dimension D</b>	F3SG-□SR□△△△△-14	C-20
	F3SG-□SR□△△△△-25	C-40
	F3SG-□SR□△△△△-45	
	F3SG-□SR□△△△△-85	
<b>Dimension G</b>	$C+27.2+N1+N2$	
<b>Dimension H</b>	$C+38+N1+N2$	
<b>Dimension I</b>	$C+58+N1+N2$	
<b>Dimension N1</b>	0 to 30 *2	
<b>Dimension N2</b>	0 to 30 *2	
<b>Dimension P</b>	F3SG-□SR□△△△△-14	10
	F3SG-□SR□△△△△-25	20
	F3SG-□SR□△△△△-45	40
	F3SG-□SR□△△△△-85	80

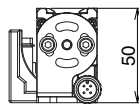

Protective height (Dimension C)	Number of Adjustable Top/Bottom Bracket *3	Number of Intermediate Bracket *3	Dimension F
0160 to 0840	2	0	---
0880 to 1680	2	1	1000 mm max.
1760 to 2480	2	2	1000 mm max.

\*1. Adjustable Side-Mount Bracket: M5 or M6

\*2. For the model of protective height of 0160, the numbers corresponding to dimensions N1 and N2 are 20 to 30.

\*3. The number of brackets required to mount either one of emitter and receiver.

Side Mounting

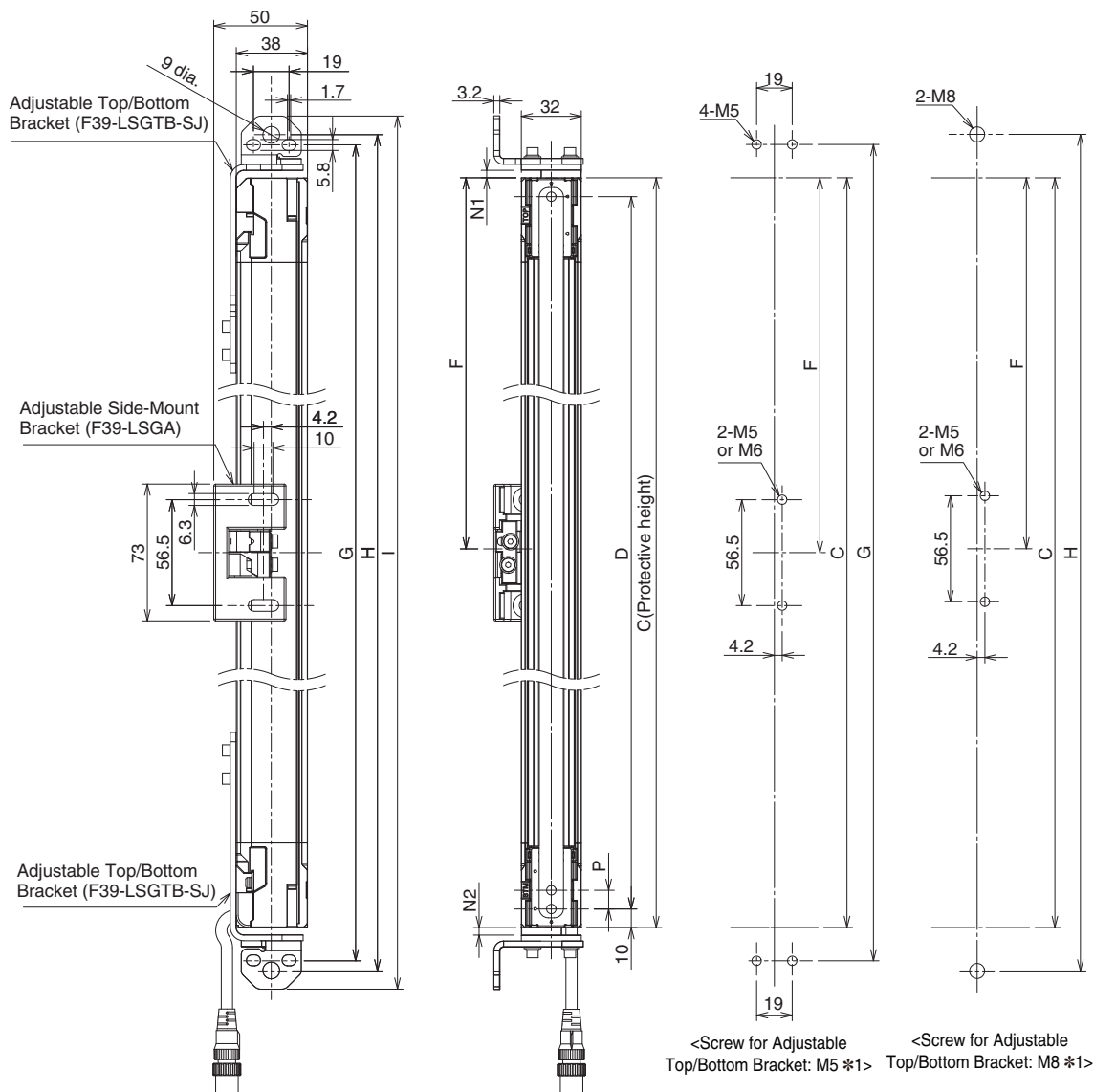

<Screw for Adjustable Top/Bottom Bracket: M5 \*1> <Screw for Adjustable Top/Bottom Bracket: M8 \*1>

<b>Dimension C</b>	4-digit number of the type name (Protective height: $\Delta$ )	
<b>Dimension D</b>	F3SG-□SR□△△△△-14	C-20
	F3SG-□SR□△△△△-25	
	F3SG-□SR□△△△△-45	C-40
	F3SG-□SR□△△△△-85	
<b>Dimension G</b>	C+27.2+N1+N2	
<b>Dimension H</b>	C+38+N1+N2	
<b>Dimension I</b>	C+58+N1+N2	
<b>Dimension N1</b>	0 to 30 *2	
<b>Dimension N2</b>	0 to 30 *2	
<b>Dimension P</b>	F3SG-□SR□△△△△-14	10
	F3SG-□SR□△△△△-25	20
	F3SG-□SR□△△△△-45	40
	F3SG-□SR□△△△△-85	80

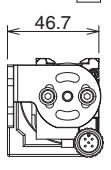

Protective height (Dimension C)	Number of Adjustable Top/Bottom Bracket *3	Number of Intermediate Bracket *3	Dimension F
0160 to 0840	2	0	---
0880 to 1680	2	1	1000 mm max.
1760 to 2480	2	2	1000 mm max.

\*1. Adjustable Side-Mount Bracket: M5 or M6  
 \*2. For the model of protective height of 0160, the numbers corresponding to dimensions N1 and N2 are 20 to 30.  
 \*3. The number of brackets required to mount either one of emitter and receiver.

Dimensions

Accessories

Bracket

Side-Mount Bracket (Intermediate Bracket) (F39-LSGF)

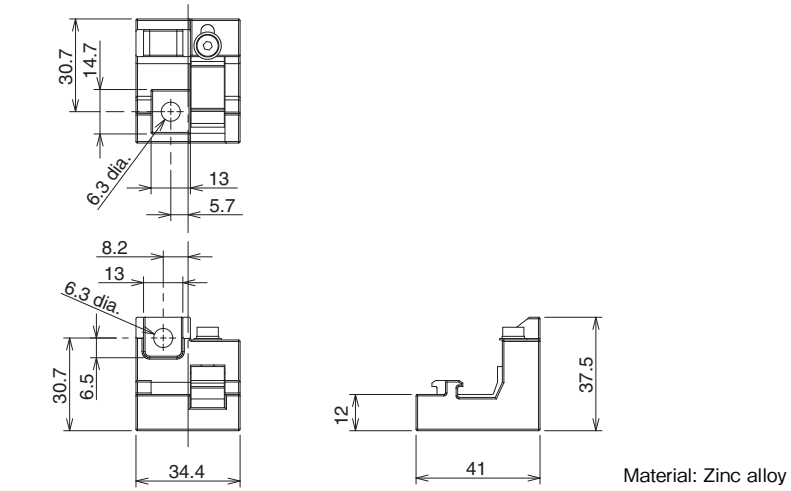

Adjustable Side-Mount Bracket (Intermediate Bracket) (F39-LSGA, sold separately)

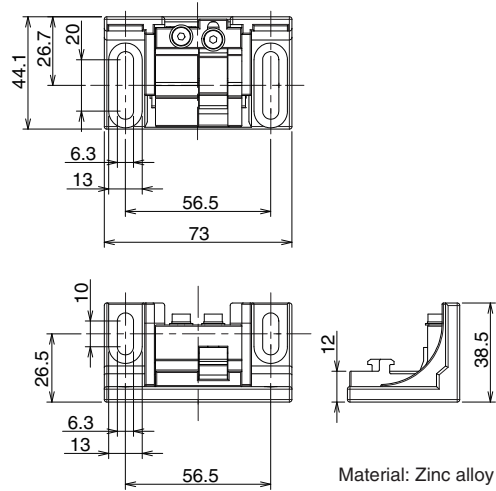

Adjustable Top/Bottom Bracket (F3SJ, F3SN Adapter) (F39-LSGTB-SJ, sold separately)

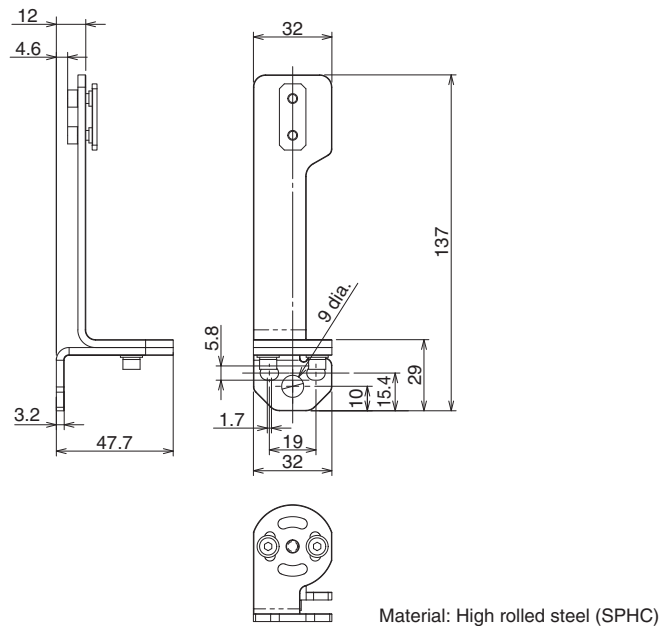

**Adjustable Top/Bottom Bracket (F3SG-RA/RE Adapter) (F39-LSGTB-RE, sold separately)**

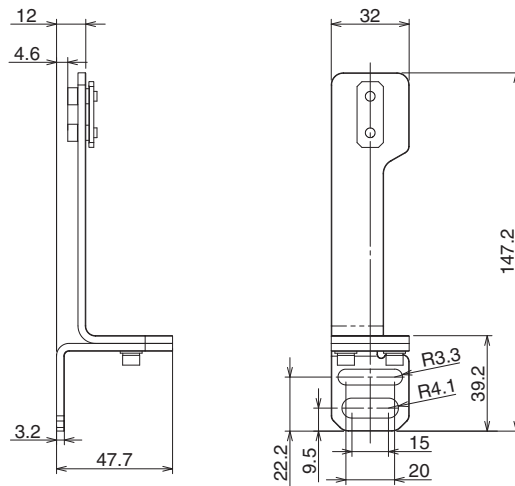

Material: High rolled steel (SPHC)

**Adjustable Top/Bottom Bracket (MS4800, F3SR Adapter) (F39-LSGTB-MS, sold separately)**

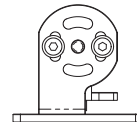
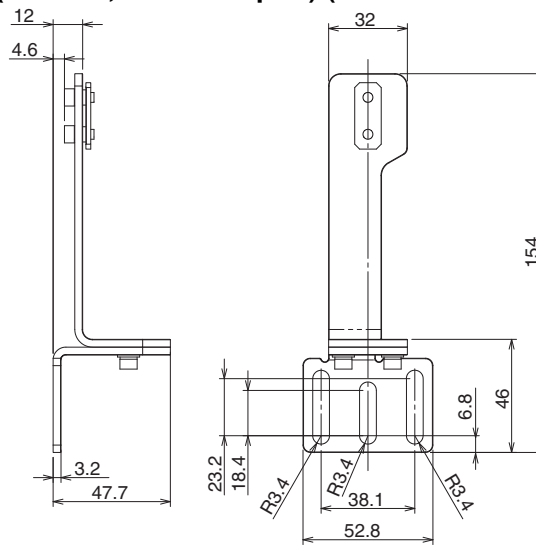

Material: High rolled steel (SPHC)

# F3SG-SR/PG

## Intelligent Tap

### Intelligent Tap (F39-SGIT-IL3, sold separately)

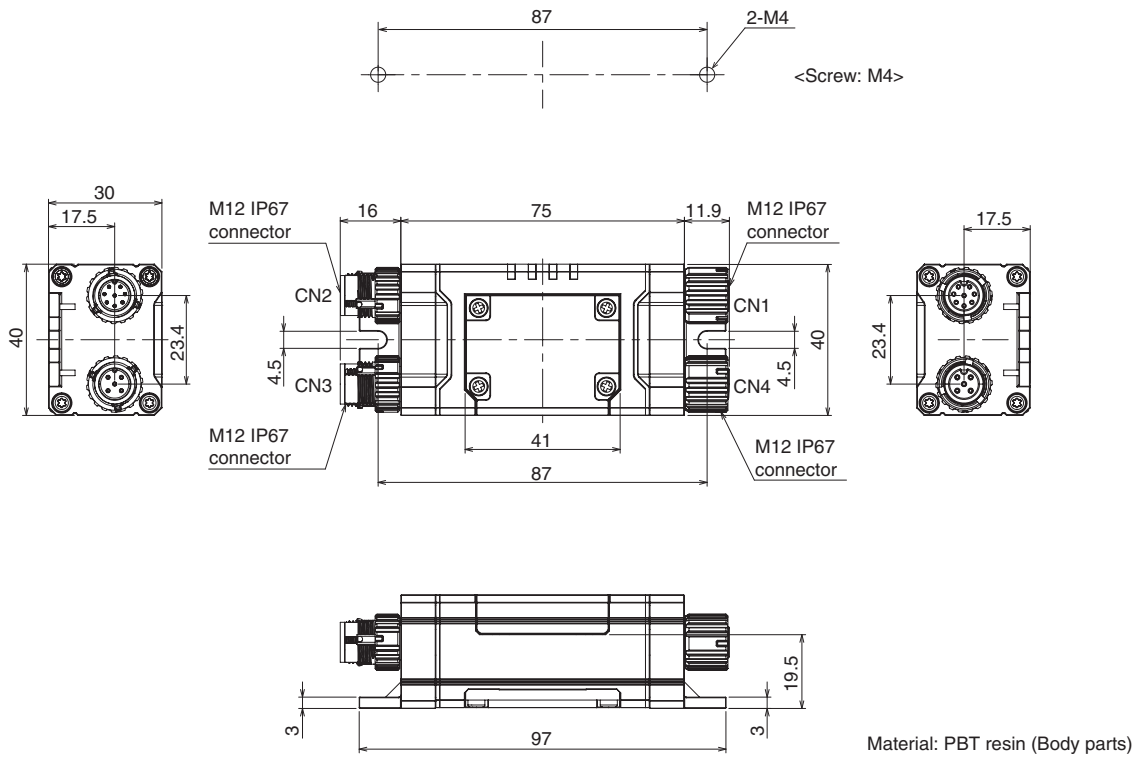

### Intelligent Tap Bracket (F39- LITF1, sold separately)

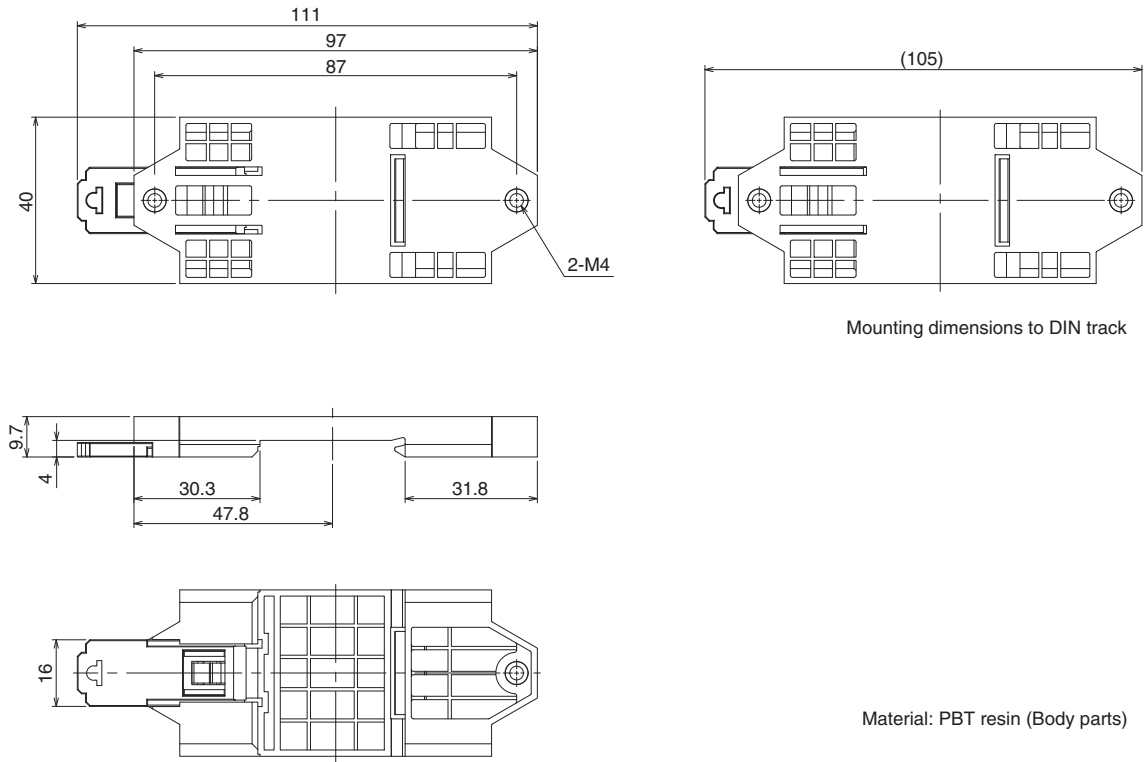

**Assembly Dimensions (Intelligent Tap/ Intelligent Tap Bracket)**

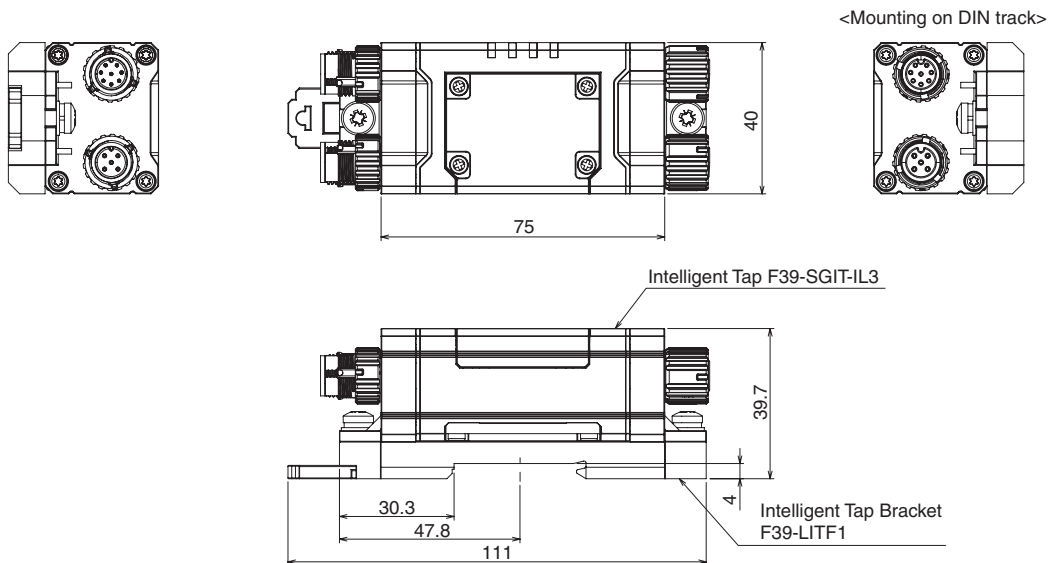

Material: PBT resin (Body parts)

**Bluetooth® Communication Unit (F39-SGBT, sold separately)**

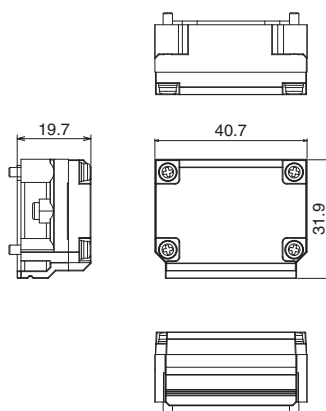

Material: PBT resin (Body parts)

**Assembly Dimensions (Intelligent Tap/Bluetooth® Communication Unit/Intelligent Tap Bracket)**

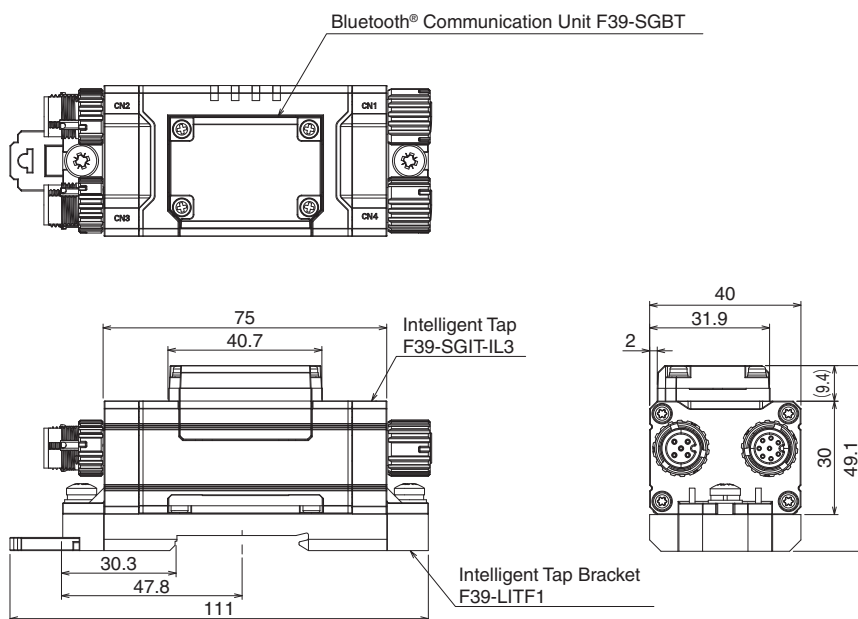

Dimensions

## Spatter Protection Cover

Spatter Protection Cover (F39-HSG□□□□, sold separately)

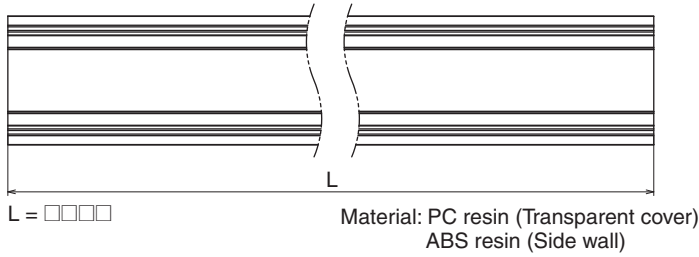
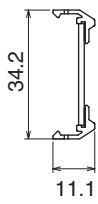

## Assembly Dimensions

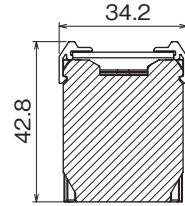

## Connecting cable

### Root-Straight Cable

Root-Straight Cable for Emitter (F39-JG□□-L, sold separately)

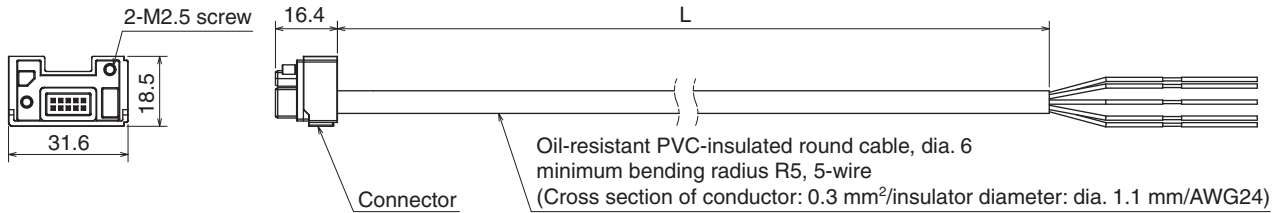

Root-Straight Cable for Receiver (F39-JG□□-D, sold separately)

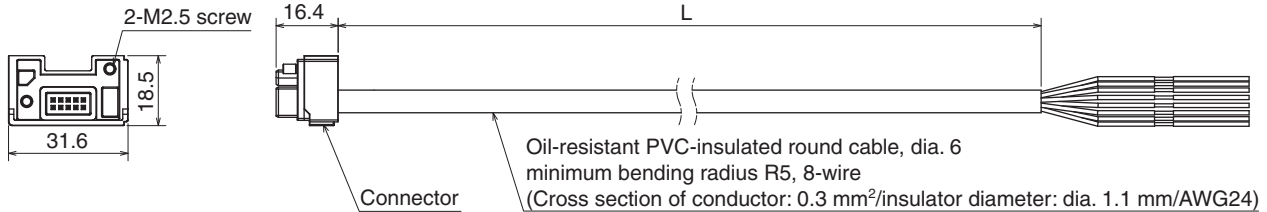

Emitter cable (Gray)	Receiver cable (Black)	Length (L)
F39-JG3C-L	F39-JG3C-D	3 m
F39-JG7C-L	F39-JG7C-D	7 m
F39-JG10C-L	F39-JG10C-D	10 m

### Root-Plug Cable for Extended

Root-Plug Cable for Extended for Emitter (F39-JGR□□-L, sold separately)

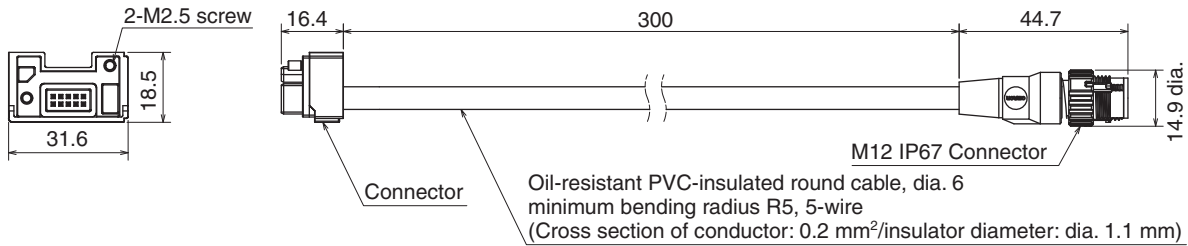

Root-Plug Cable for Extended for Receiver (F39-JGR□□-D, sold separately)

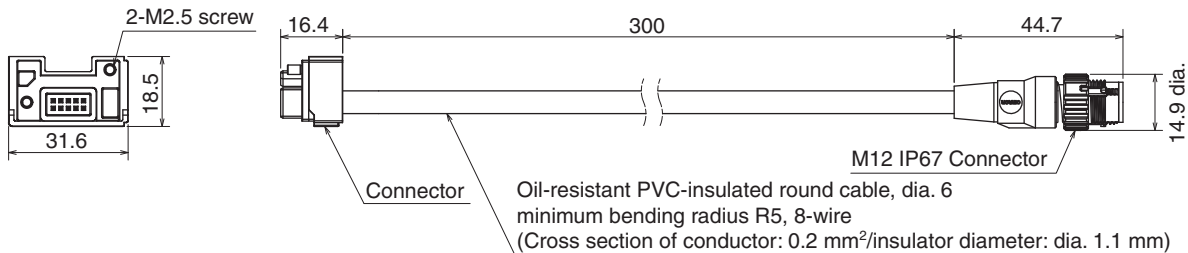

Emitter cable (Gray)	Receiver cable (Black)	Length
F39-JGR3K-L	F39-JGR3K-D	0.3 m

### Extended Socket-Straight Cable

Extended Socket-Straight Cable for Emitter (F39-JG□A-L, sold separately)

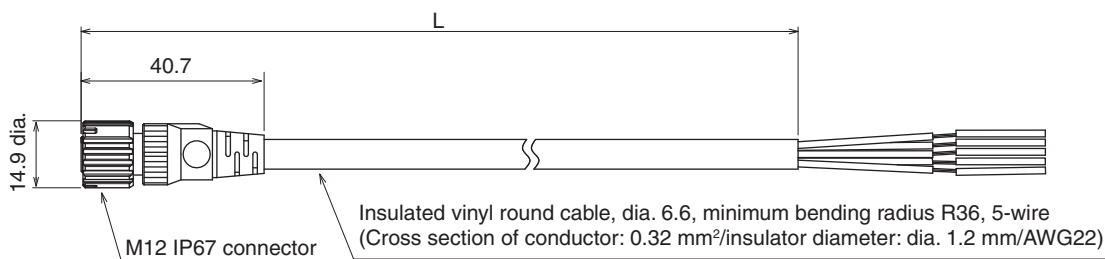

Extended Socket-Straight Cable for Receiver (F39-JG□A-D, sold separately)

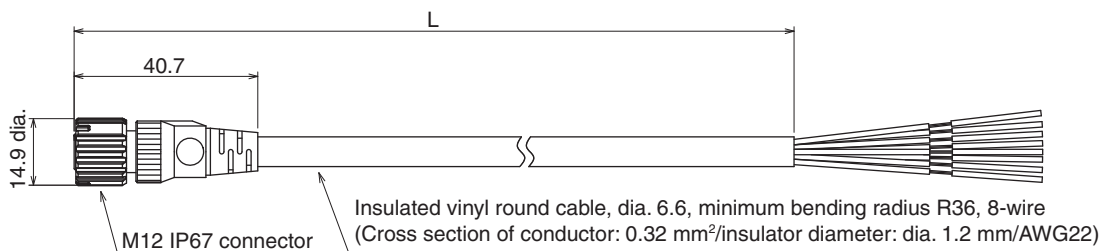

Emitter cable (Gray)	Receiver cable (Black)	Length (L)
F39-JG3A-L	F39-JG3A-D	3 m
F39-JG10A-L	F39-JG10A-D	10 m

### Extended Plug-Socket Cable

Extended Plug-Socket Cable for Emitter: Cable for extension (F39-JG□B-L, sold separately)

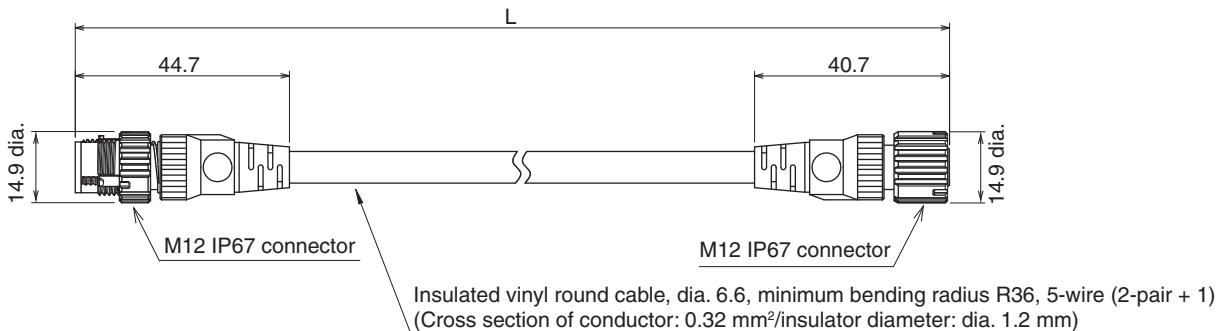

Extended Plug-Socket Cable for Receiver: Cable for extension (F39-JG□B-D, sold separately)

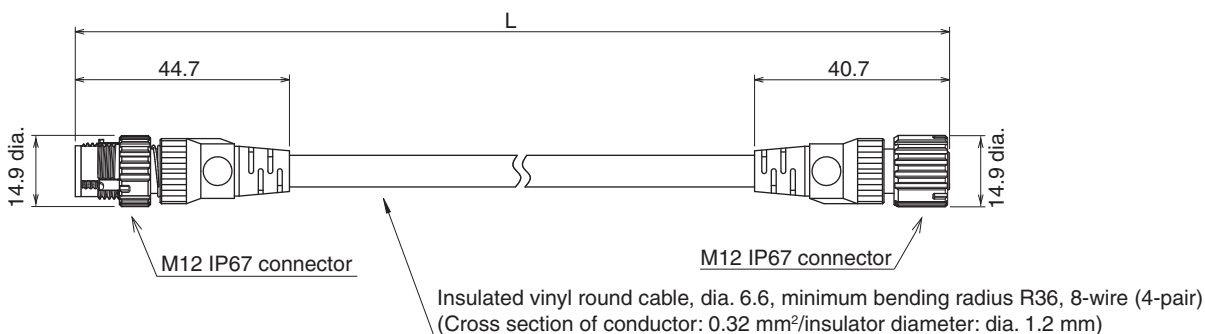

Emitter cable (Gray)	Receiver cable (Black)	Length (L)
F39-JG3B-L	F39-JG3B-D	3 m
F39-JG10B-L	F39-JG10B-D	10 m
F39-JG20B-L	F39-JG20B-D	20 m

Dimensions

# F3SG-SR/PG

## Cascading Cable for Extended (F39-JGR3W, sold separately) (two cables per set, one for emitter and one for receiver)

### Emitter Cascading Cable for Extended

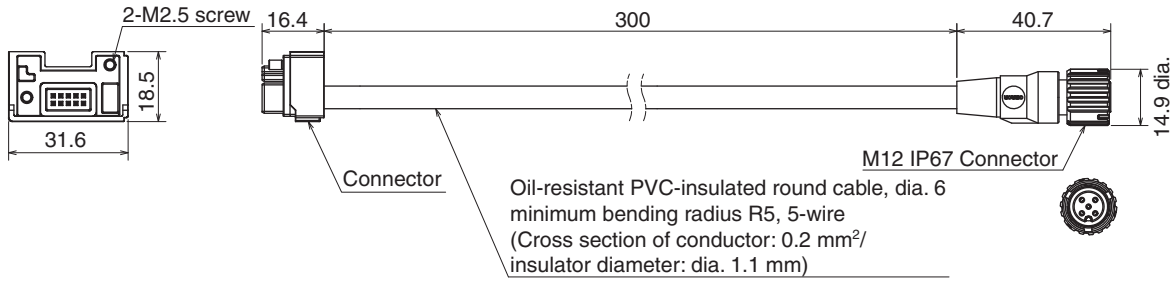

### Receiver Cascading Cable for Extended

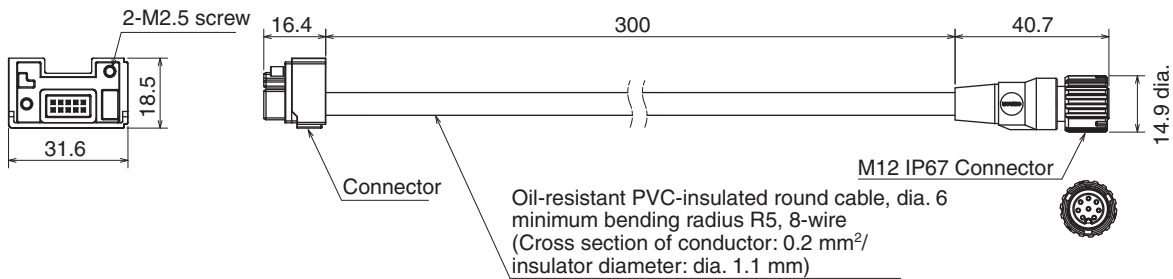

Set model name	Emitter cable (Gray)	Receiver cable (Black)	Length
F39-JGR3W	F39-JGR3W-L	F39-JGR3W-D	0.3 m

## Side-by-side Cascading Cable (F39-JGR12L, sold separately) (two cables per set, one for emitter and one for receiver)

### Side-by-side Cascading Cable for Emitter

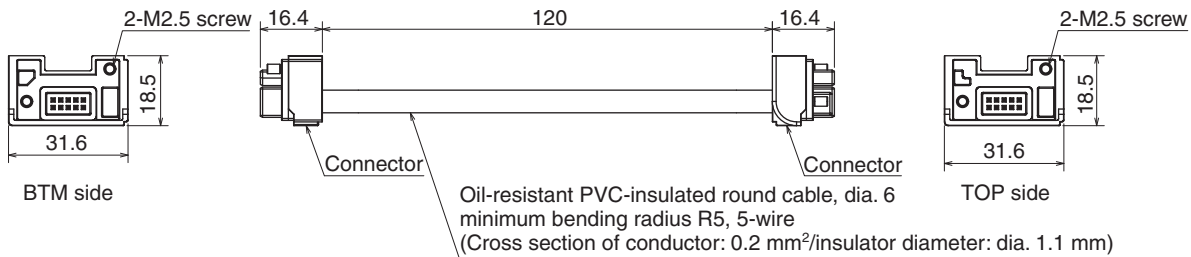

### Side-by-side Cascading Cable for Receiver

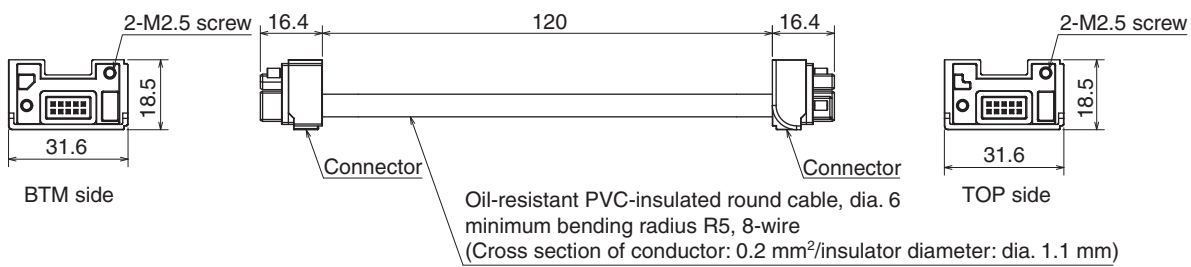

Set model name	Emitter cable (Gray)	Receiver cable (Black)	Length
F39-JGR12L	F39-JGR12L-L	F39-JGR12L-D	12 cm

## Conversion Cable

### F3SJ-B/A Conversion Cable for Emitter (F39-JGR3K-SJ-L, sold separately)

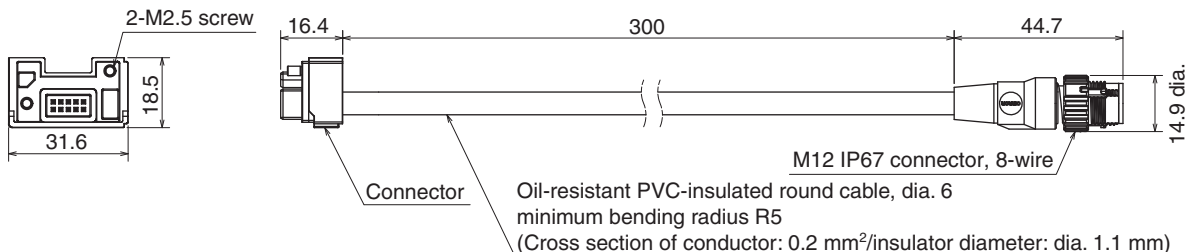

**F3SJ-B/A Conversion Cable for Receiver (F39-JGR3K-SJ-D, sold separately)**

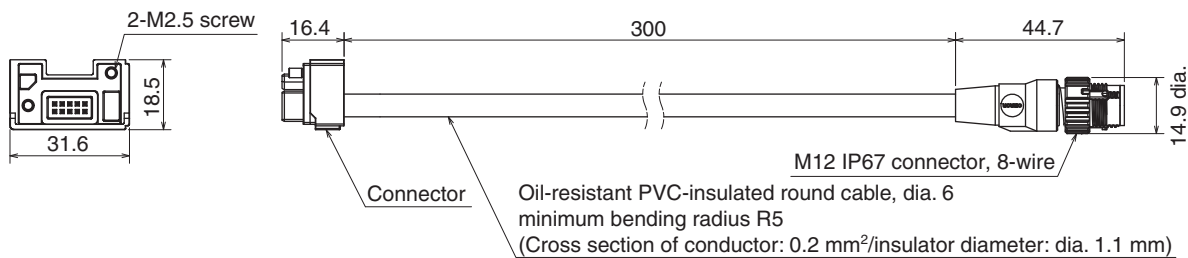

Emitter cable (Gray)	Receiver cable (Black)	Length
F39-JGR3K-SJ-L	F39-JGR3K-SJ-D	0.3 m

**F3SG-RE Conversion Cable for Emitter (F39-JGR3K-RE-L, sold separately)**

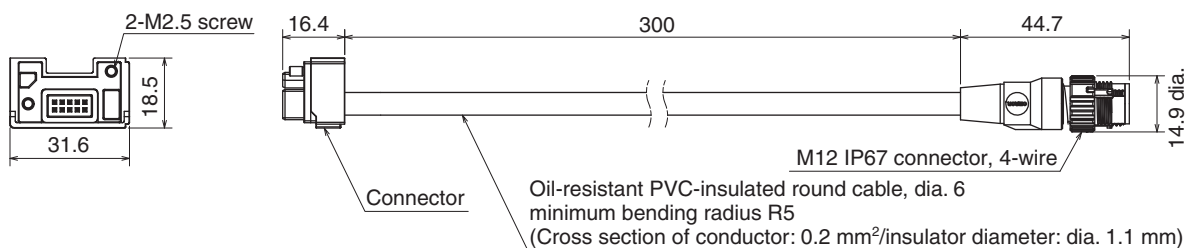

**F3SG-RE Conversion Cable for Receiver (F39-JGR3K-RE-D, sold separately)**

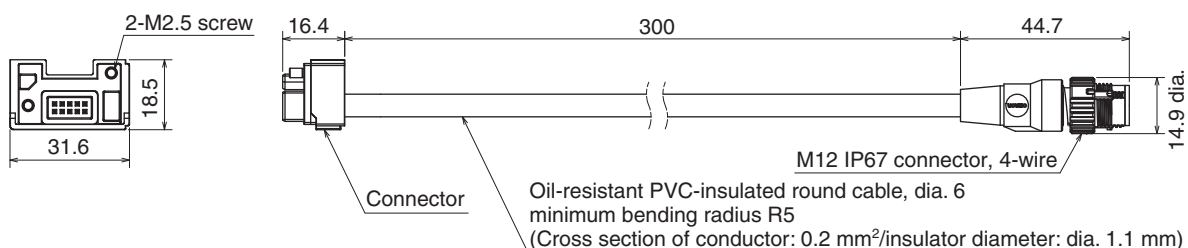

Emitter cable (Gray)	Receiver cable (Black)	Length
F39-JGR3K-RE-L	F39-JGR3K-RE-D	0.3 m

**MS48 Conversion Cable for Emitter (F39-JGR3K-MS-L, sold separately)**

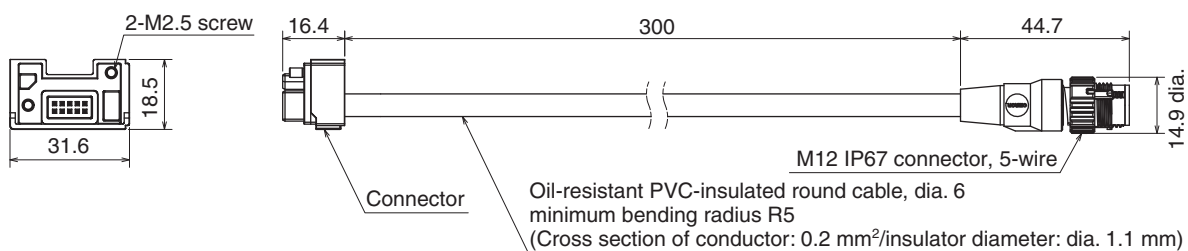

**MS48 Conversion Cable for Receiver (F39-JGR3K-MS-D, sold separately)**

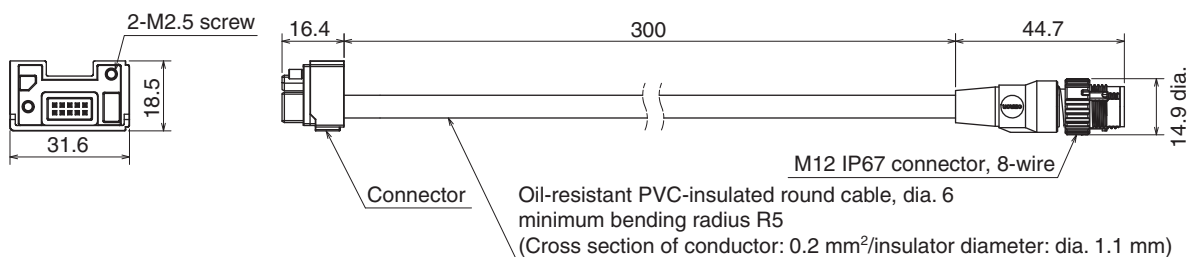

Emitter cable (Gray)	Receiver cable (Black)	Length
F39-JGR3K-MS-L	F39-JGR3K-MS-D	0.3 m

Dimensions

# F3SG-SR/PG

## Y-Joint Plug/Socket Connector (F39-GCNY2, sold separately)

Plug marked with ● (blue circle): Connect to control panel side  
 Socket marked with ○ (open circle): Connect to emitter

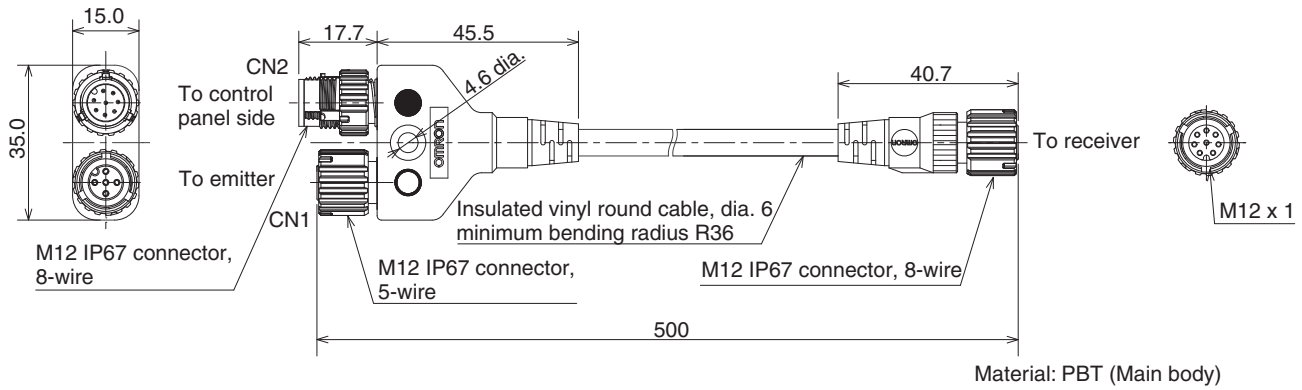

Model	Length
F39-GCNY2	0.5 m

## Reset Switch Connector (F39-GCNY3, sold separately)

Plug marked with ● (blue circle): Connect to control panel side  
 Plug marked with ○ (open circle): Connect to reset switch side

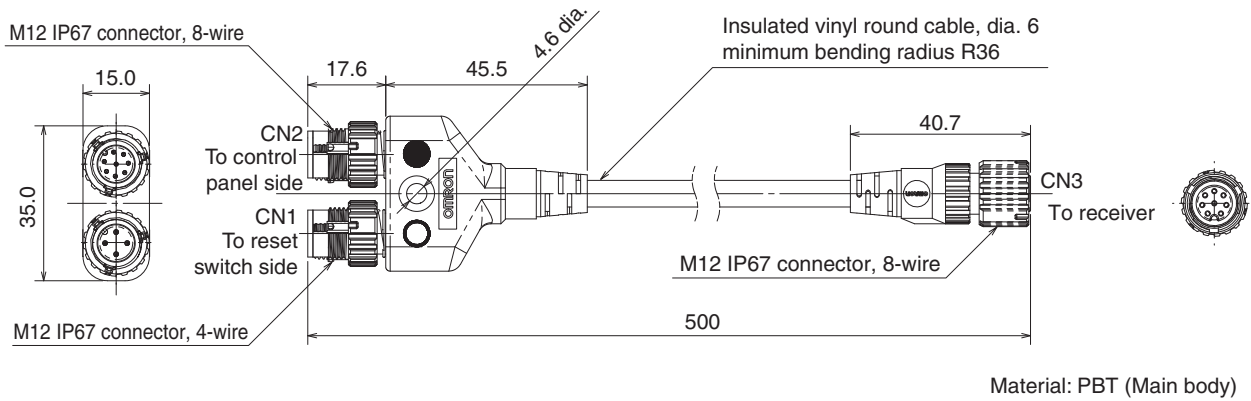

Model	Length
F39-GCNY3	0.5 m

## Connector Connected to Cable, Socket on One Cable End (XS5F-D421-□80-F, sold separately)

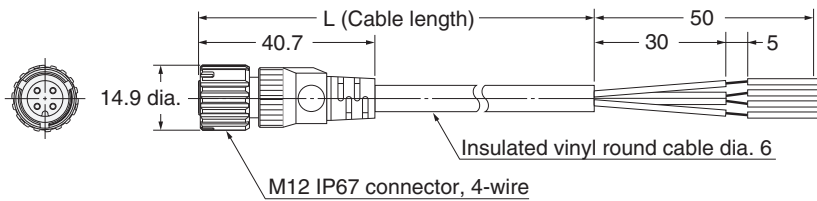

Model	Length (L)
XS5F-D421-C80-F	1 m
XS5F-D421-D80-F	2 m
XS5F-D421-E80-F	3 m
XS5F-D421-G80-F	5 m
XS5F-D421-J80-F	10 m
XS5F-D421-L80-F	20 m

# Troubleshooting

## F3SG-SR LOCKOUT State

Identify an error according to the combination of the indicators when the error occurs. See the following troubleshooting tables to take measures. For detail, Refer to *User's Manual* (Man. No. Z405).

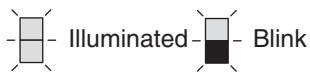

<Indicator status at lockout: Receiver>

Combination of indicators and error description

ERR indicator	MAINT indicator	Other indicators	Error description	
<p>Blinking once</p>	<p>[Error description]</p> Recoverable error Red blinking : Replacement-recommended error		Safety Output error	
			Error due to change of PNP/NPN polarity during operation	
			Blanking monitoring error Configuration error Parameter error	
		TOP *1	Cap error Other sensor error	
<p>Blinking twice</p>		BTM *2	DIP Switch setting error	
			Safety output error due to power supply voltage or noise	
<p>Blinking once</p>			---	Communication error External device monitoring error Error other than those above
			---	Intelligent Tap error
---			---	Intelligent Tap error

\*1. For F3SG-SRA, the Area Beam Indicator closer to the "TOP" mark on the F3SG-SR blinks.

\*2. For F3SG-SRA, the Area Beam Indicator closer to the "BTM" mark on the F3SG-SR blinks.

<Indicator status at lockout: Emitter>

Combination of indicators and error description

ERR indicator	Other indicators	Error description
<p>Blinking once</p>		Operating range selection setting error
	TOP *1 *3	Cap error Other sensor error
	BTM *2 *3	DIP Switch setting error
	---	Communication error Error other than those above

\*1. For F3SG-SRA, the Area Beam Indicator closer to the "TOP" mark on the F3SG-SR blinks.

\*2. For F3SG-SRA, the Area Beam Indicator closer to the "BTM" mark on the F3SG-SR blinks.

\*3. The indicator blinks only in the case the Wired Synchronization is enabled and is off in the case the Optical Synchronization is enabled.

Dimensions  
Troubleshooting

Description	Checking by		Error code (hex) *1	Cause and measures
	Indicator	SD Manager 3/ SD Manager 3 Mobile APP		
Safety output error	X	X	60, 6B, 6C	The OSSD lines may be short-circuited to each other or another signal line may be short-circuited to the OSSD line. Wire the OSSD lines properly.
			56	The polarity does not match between the power supply and the OSSD lines. Check if a correct polarity is selected for the PNP/NPN setting according to your application. Also check: <ul style="list-style-type: none"> <li>if the power supply (0 VDC or 24 VDC) of the Intelligent Tap and F3SG-SR is wired as intended.</li> <li>if the OSSD lines are properly wired.</li> </ul>
Recoverable error	X	---	---	The error may occur due to a temporary cause. Identify the cause by the status of the other LED indicator and take measures.
Replacement-recommended error				The error may occur due to a product failure. If the measure according to the status of the other LED indicator does not work, it is recommended to replace the F3SG-SR.
Intelligent Tap error	X	---	---	An error due to noise may have occurred in the internal circuit of the Intelligent Tap. Check the noise level in the environment. The internal circuit of the Intelligent Tap may be defective. Replace the Intelligent Tap.
Error due to change of PNP/NPN polarity during operation	X	X	E7	An error due to noise may have occurred in the internal circuit. Check the noise level in the environment. The internal circuit may be defective. Replace the F3SG-SR.
Blanking monitoring error	X	X	EC	An error is detected by the Fixed Blanking Monitoring function or the Floating Blanking Monitoring function.
Configuration error	X	X	39, 3A, 3B	The cascading cable may be short-circuited, broken, or disconnected. Check that the cascading cable should be tightly connected. If the cascading cable is broken, replace it. The number of connected sensors or beams may have exceeded the maximum value due to cascading. Check the configuration.
			3C, 3E, 3F	A model name does not match between emitter and receiver. Check that the emitter and receiver are the same model.
			34	An error may have occurred to the internal information of the model name of the F3SG-SR due to effect of noise. If other devices using the same power supply generate noise, do not share the same power supply with other devices, and use a separate power supply exclusively for the safety components. The inductive noise tends to be induced especially if the power supply line of the machine guarded and the power supply line of the Intelligent Tap are arranged in parallel. Arrange the exclusive power supply near the Intelligent Tap or lay the power supply line of the Intelligent Tap away from the power supply line of the machine guarded. If the power supply for the Intelligent Tap is located near the power supply of the machine guarded and it shares the same grounding wire, it is subject to the influence of common mode noise. Separate the grounding point or use it as the exclusive ground.
				An error may have occurred in the internal circuit. Replace the F3SG-SR.
Parameter error	X	X	F1	The settings do not match between the Intelligent Tap and F3SG-SR. Perform the Backup.
			40	The settings of the F3SG-SR may be faulty. Check if the settings are correct.

Description	Checking by		Error code (hex) *1	Cause and measures
	Indicator	SD Manager 3/ SD Manager 3 Mobile APP		
Cap error	X	X	4F	A cap may be detached. Attach the cap properly.
Other sensor error	X	X	38	Other sensor being cascaded caused an error. Check the indicator of the sensor.
DIP Switch setting error	X	X	E7, E8	A DIP Switch on the Intelligent Tap setting may have been changed during operation. Check if a DIP Switch setting was changed or not.
Communication error	---	X	30, 32	The communication lines or other lines may be short-circuited or broken. Check if the cascading or extension cables. If the cascading cable or extension cables is broken, replace it.
			31	An error may have occurred to the communication due to effect of noise. If other devices using the same power supply generate noise, do not share the same power supply with other devices, and use a separate power supply exclusively for the safety components. The inductive noise tends to be induced especially if the power supply line of the machine guarded and the power supply line of the Intelligent Tap are arranged in parallel. Arrange the exclusive power supply near the Intelligent Tap or lay the power supply line of the Intelligent Tap away from the power supply line of the machine guarded. If the power supply for the Intelligent Tap is located near the power supply of the machine guarded and it shares the same grounding wire, it is subject to the influence of common mode noise. Separate the grounding point or use it as the exclusive ground. An error may have occurred in the internal circuit. Replace the F3SG-SR.
Safety output error due to power supply voltage or noise	X	X	19	The power supply voltage may have dropped temporarily when the F3SG-SR is in operation. Check for temporary power supply voltage drop (by about 12 VDC) by the influence of the inductive load, etc. If the exclusive power supply is not used, check the power consumption of other connected devices for enough capacity. Power supply voltage may be outside the rated range. Connect the F3SG-SR to a 24 VDC±20% power supply voltage. Voltage fluctuation may have occurred due to insufficient power supply capacity. Replace the power supply with one that has a larger capacity. Instantaneous break or instantaneous stop may have occurred due to power sharing with other devices. Do not share the power supply with other devices. Connect the F3SG-SR to a power supply that is dedicated to electro-sensitive protective devices for electro-sensitive protective equipment such as the F3SG-SR, safety controller, etc.
			1A	Effect of noise may be excessive. If other devices using the same power supply generate noise, do not share the same power supply with other devices, and use a separate power supply exclusively for the safety components. The inductive noise tends to be induced especially if the power supply line of the machine guarded and the power supply line of the F3SG-SR are arranged in parallel. Arrange the exclusive power supply near the F3SG-SR or lay the power supply line of the F3SG-SR away from the power supply line of the machine guarded. If the power supply for the F3SG-SR is located near the power supply of the machine guarded and it shares the same grounding wire, it is subject to the influence of common mode noise. Separate the grounding point or use it as the exclusive ground.

Description	Checking by		Error code (hex) *1	Cause and measures
	Indicator	SD Manager 3/ SD Manager 3 Mobile APP		
Operating range selection setting error	X	X	EB	The setting of the operating range selection may be incorrect. <ul style="list-style-type: none"> <li>When the Intelligent Tap is connected, check if the Operating Range Selection of the DIP Switch is properly set.</li> <li>When the Intelligent Tap is not connected, check if the Operating Range Select Input line is properly wired.</li> </ul>
External device monitoring error	--- *2	X	52	Relay may be welded. Replace the relay. The relay and the RESET line may not be properly wired. Check the wiring with the relay. The relay response time may be exceeding the allowable delay time. Change the allowable delay time or replace the relay with one that has an appropriate response time.
Error other than those above	--- *2	X	Error code other than those above	An error may have occurred in the internal circuit. Replace the F3SG-SR.

\*1. You can check the error codes by SD Manager 3 or SD Manager 3 Mobile APP.

\*2. Other indicators than the ERR and MAINT indicators are not illuminated. For details of the error, refer to [Code] and [Error description] displayed in [Error Log] in the SD Manager 3.

## Warning

Identify an error according to the combination of the indicators when the error occurs. See the following troubleshooting tables to take measures. For detail, Refer to *User's Manual* (Man. No. Z405).



<Indicator status at warning: Receiver \*1>

Combination of indicators and error description

ERR indicator	MAINT indicator	Other indicators	Error description
			Teach-in error
			Muting sequence error, Interlock sequence error or PSDI sequence error
		Area Beam Indicator Green	Malfunction due to ambient light or vibration
		Area Beam Indicator Orange  → After 5 to 10 s	Low incident light level

\*1. In the warning state, no indicators on the emitter are illuminated or blink.

\*2. There are several illumination patterns to identify a faulty sequence.

Description	Checking by		Warning code (hex) *1	Cause and measures
	Indicator	SD Manager 3/ SD Manager 3 Mobile APP		
Teach-in error	X	X	ED	Teach-in failed. Perform the Teach-in again.
Muting sequence error	X	X	2C, 2D, 2F	Muting input may have been applied in the incorrect order. Check the pattern of illumination of the LED indicator to identify the cause.
Interlock sequence error	X	---	---	When using the Pre-Reset function, the reset signals for interlock may be input in the wrong order. Check the pattern of illumination of the LED indicator to identify the cause.
PSDI sequence error	X	X	2A, 2B	PSDI input may have been applied in the correct order. Check if the pattern of illumination of the LED indicator to identify the cause.
Malfunction due to ambient light or vibration	X	X (SD Manager 3 Mobile APP is not applicable) *2	---	Malfunction may have occurred due to ambient light or instantaneous beam misalignment from vibration. Check the installation condition.
Low incident light level	X	X	12	The incident light level may be low due to dirty front window or misaligned beams caused by vibration. Clean the front window and check the alignment of the beams.
Low communications quality	--- *3	X	F0	Retries of communications may have been generated due to noise. Check the noise level in the proximity of the communication lines. Retries of communications may have been generated due to short-circuit of the communication lines. Check the cables connected.







\*1. You can check the warning codes by SD Manager 3 or SD Manager 3 Mobile APP.

\*2. You can check by instantaneous block detection logs in [Instantaneous Block Detection Information].

\*3. The indicators are not illuminated. For details of the warning, refer to [Code] and [Warning description] displayed in [Warning Log] in the SD Manager 3.

## Muting Sequence Error Indication



The following table is applied only when the muting function is being enabled.

SEQ indicator	Cause and measures
 Blinking: Once	Power supply may have been turned ON with muting input A or B being ON. Check the condition of the muting sensors and the F3SG-SR.
	Muting input B may have been turned ON before muting input A was turned ON. Check the condition of the muting sensors.
	Muting input A and B may have been turned ON at the same time. <ul style="list-style-type: none"> <li>• Check the arrangement of the muting sensors.</li> <li>• Check if the wiring of muting input A and B is short-circuited.</li> </ul>
	Either muting input A or B may have been turned ON with the F3SG-SR being blocked or INTERLOCK State. Check the condition of the F3SG-SR.
 Blinking: Twice	Muting input B may have been turned ON within T1min (= 0.1 s*) after muting input A was turned ON. <ul style="list-style-type: none"> <li>• Check that if the muting sensors are installed too close each other.</li> <li>• Check that if the speed of the workpiece is too fast.</li> </ul>
	It may have taken T1max (= 4 s*) or longer for muting input B to be turned ON after muting input A was turned ON. <ul style="list-style-type: none"> <li>• Check that if the muting sensors are installed too far each other.</li> <li>• Check that if the speed of the workpiece is too slow.</li> </ul>
	The F3SG-SR may have been blocked after muting input A was turned ON but before muting input B was turned ON. Check the condition of the F3SG-SR.
 Blinking: Four times	The F3SG-SR may have been blocked within 0.08 s after muting input A and B were normally turned ON. <ul style="list-style-type: none"> <li>• Check that if the muting sensor and the F3SG-SR are installed too close each other.</li> <li>• Check that if the speed of the workpiece is too fast.</li> </ul>
	Muting may have been released after the F3SG-SR entered the MUTING state but before a workpiece blocked the F3SG-SR. <ul style="list-style-type: none"> <li>• Check that the workpiece still remains.</li> <li>• Check that the speed of the workpiece is too slow.</li> </ul>
 Blinking: Five times	The F3SG-SR entered the MUTING state, but muting may have then been released while a workpiece passes through the F3SG-SR. <ul style="list-style-type: none"> <li>• Check that the workpiece still remains.</li> <li>• Check that if the speed of the workpiece is too slow.</li> <li>• Check that the muting sensors have been installed upstream and downstream of the F3SG-SR with the size of workpieces taken into account. (Using four muting sensors)</li> </ul>
 Blinking: Six times	Muting may have been released with muting input A and B remained ON after a workpiece passed through the F3SG-SR. <ul style="list-style-type: none"> <li>• Check that the workpiece still remains.</li> <li>• Check that the speed of the workpiece is too slow.</li> </ul>
 Blinking: Seven times	The next muting sequence may have started after muting was released but before the initial muting condition was established. <ul style="list-style-type: none"> <li>• Check that if a next workpiece has not entered before the current workpiece passes through the F3SG-SR.</li> <li>• Check that if the interval between workpieces are too narrow.</li> </ul>

\* Factory default setting





## Interlock Sequence Error Indication

The following table is applied only when the pre-reset function is being enabled.

SEQ indicator	Cause and measures
 Blinking: Once	The reset or pre-reset switch may have been pressed before the F3SG-SR receives light. Check the wiring of the reset and pre-reset signals.
	The F3SG-SR may have been blocked or the pre-reset switch may have been pressed before the pre-reset switch is pressed. Check the status of the F3SG-SR and the wiring of the pre-reset signal.
 Blinking: Twice	After the pre-reset switch was pressed, the pre-reset or reset switch may have been pressed before the F3SG-SR is blocked. Check the installation environment of the F3SG-SR.
 Blinking: Three times	After the pre-reset switch was pressed and the F3SG-SR was blocked, the pre-reset switch may have been pressed before the reset switch is pressed. Check the wiring of the pre-reset signal.
	After the pre-reset switch was pressed, a time period from the block of the F3SG-SR to the press of the reset switch may have exceeded the allowable time. Check the installation environment of the F3SG-SR as well as pre-reset and reset switches.
	The number of blocks of the F3SG-SR may have exceeded the allowable value after the pre-reset switch was pressed and before the reset switch is pressed. Check the installation environment of the F3SG-SR.

### PSDI Sequence Error Indication

The following table is applied only when the PSDI function is being enabled.

SEQ indicator	Error condition	Cause and measures
 Blinking: Once	●	Power supply may have been turned ON with PSDI input being OFF. Check the condition of the light curtains and PSDI input wiring.
	●	Power supply may have been turned ON with the light curtain blocked. Check the condition of the light curtains and PSDI input wiring.
	●	Power supply may have been turned ON with RESET input being OFF. Check the condition of the light curtains and RESET input wiring.
	●	PSDI input may have been turned OFF before RESET input was turned OFF. Check the PSDI input wiring.
	●	The light curtain may have been blocked before RESET input was turned ON. Check the condition of the light curtains and RESET input wiring.
	●	The PSDI input may have turned OFF while the RESET input is OFF. Check the condition of the light curtains and PSDI input wiring.
	●	The light curtain may have been blocked before RESET input was turned ON. Check the condition of the light curtains and RESET input wiring.
 Blinking: Twice	●	After RESET input , the light curtain may not be blocked longer than T2 and the PSDI input may have turned OFF. Check the condition of the light curtains and RESET input wiring.
	●	The PSDI input may have turned OFF with the light curtain blocked. Check the condition of the light curtains and PSDI input wiring.
	◎	PSDI input may have turned OFF before the light curtain blocked twice. Check the condition of the light curtains and PSDI input wiring.
 Blinking: Three times	●	The light curtain was blocked before the PSDI input turned OFF. Check the condition of the light curtains and PSDI input wiring.
	●	The light curtain was blocked while the PSDI input turned OFF. Check the condition of the light curtains and PSDI input wiring.
 Blinking: Four times	●	PSDI input may have turned OFF during the period from when the PSDI state is canceled until the light curtain blocked. Check the condition of the light curtains and PSDI input wiring.
	●	The PSDI input may have turned OFF with the light curtain blocked. Check the condition of the light curtains and PSDI input wiring.
	○	It may have taken T4 (= 30 s) or longer for PSDI input to be turned OFF after the light curtain blocked. Check the condition of the light curtains and PSDI input wiring.
	◎	It may have taken T6 (= 30 s) or longer for PSDI input to be turned OFF after the light curtain blocked. Check the condition of the light curtains and PSDI input wiring.
	◎	The PSDI input may have turned OFF again before the light curtain blocked. Check the condition of the light curtains and PSDI input wiring.
	◎	It may have taken T6 (= 30 s) or longer for PSDI input to be turned OFF after the light curtain blocked twice. Check the condition of the light curtains and PSDI input wiring.
	◎	PSDI input may have turned OFF before the light curtain blocked again. Check the light curtain status and PSDI input wiring.

Notations

- ...Single Break
- ◎...Double Break
- ...Common

## Intelligent Tap

If the Intelligent Tap detects any failure, it transitions to the LOCKOUT state. Under the LOCKOUT state, the ERR indicator is turned ON. Identify an error according to the combination of the indicators when the error occurs. See the following troubleshooting tables to take measures. For detail, Refer to *User's Manual* (Man. No. Z405).



### Combination of indicators and error description

ERR (Red)	IN (Yellow)	OUT (Green/Red)	IO-Link (Green)	Error description
	---	---	---	Communication error DIP Switch circuit error at startup
			---	Communication error in Backup
		Green	---	Communication error in Restoration
		Red	---	Communication error between the F3SG-SR and the Intelligent Tap
		Green	---	Restoration failed
		Red	---	LOCKOUT state of the F3SG-SR
	---	---		IO-Link circuit error
	---	---	---	Power supply voltage error, or other errors

**Note:** 1. The signals output to IO-Link or IN and OUT indicators show the statuses of the F3SG-SR or Intelligent Tap except their LOCKOUT state.  
2. The muting inputs A and B are kept in the OFF state when the LOCKOUT state occurs due to the power supply voltage error.

Description	Checking by		Error code (hex) *	Cause and measures
	Indicator	SD Manager 3/ SD Manager 3 Mobile APP		
Communication error	X	X	1D	The communication lines or other lines may be short-circuited or broken. Check the cables for cascading or extension cables. If the wiring is extended with cables other than specified, the cables used for extension may not have performance equivalent or greater than the specified cables. Use cables with the same performance or more than the specified cables.
Communication error in Backup	X	X	1E	The communication lines or other lines may be short-circuited or broken. Check the cables for cascading or extension cables. If the wiring is extended with cables other than specified, the cables used for extension may not have performance equivalent or greater than the specified cables. Use cables with the same performance or more than the specified cables. Effect of noise may be excessive. If other devices using the same power supply generate noise, do not share the same power supply with other devices, and use a separate power supply exclusively for the safety components. The inductive noise tends to be induced especially if the power supply line of the machine guarded and the power supply line of the Intelligent Tap are arranged in parallel. Arrange the exclusive power supply near the Intelligent Tap or lay the power supply line of the Intelligent Tap away from the power supply line of the machine guarded. If the power supply for the Intelligent Tap is located near the power supply of the machine guarded and it shares the same grounding wire, it is subject to the influence of common mode noise. Separate the grounding point or use it as the exclusive ground. The internal circuit of the Intelligent Tap may be defective. Replace the Intelligent Tap.

Description	Checking by		Error code (hex) *	Cause and measures
	Indicator	SD Manager 3/ SD Manager 3 Mobile APP		
Communication error in Restoration	X	X	1F	<p>The communication lines or other lines may be short-circuited or broken. Check the cables for cascading or extension cables. If the wiring is extended with cables other than specified, the cables used for extension may not have performance equivalent or greater than the specified cables. Use cables with the same performance or more than the specified cables.</p> <p>Effect of noise may be excessive. If other devices using the same power supply generate noise, do not share the same power supply with other devices, and use a separate power supply exclusively for the safety components. The inductive noise tends to be induced especially if the power supply line of the machine guarded and the power supply line of the Intelligent Tap are arranged in parallel. Arrange the exclusive power supply near the Intelligent Tap or lay the power supply line of the Intelligent Tap away from the power supply line of the machine guarded. If the power supply for the Intelligent Tap is located near the power supply of the machine guarded and it shares the same grounding wire, it is subject to the influence of common mode noise. Separate the grounding point or use it as the exclusive ground.</p> <p>The internal circuit of the Intelligent Tap may be defective. Replace the Intelligent Tap.</p>
Communication error between the F3SG-SR and the Intelligent Tap	X	---	---	The F3SG-SR may be disconnected from the Intelligent Tap, the communication line of the F3SG-SR may be broken, or the internal circuit of the Intelligent Tap may be defective. Check the connection and cable wiring between the Intelligent Tap and the F3SG-SR. In the case of defective internal circuit, replace the Intelligent Tap.
F3SG-SR LOCKOUT state	X	---	---	The F3SG-SR is in the LOCKOUT state. For details of the error of the F3SG-SR, check the indicator status or error code of the F3SG-SR.
Restoration failed	X	---	---	The sensor configuration (sensor model, connection configuration, etc.) that the Intelligent Tap stored by Backup does not match the sensor configuration of the connected the F3SG-SR. Connect the F3SG-SR with the same sensor configuration as the Backup sensor configuration. Error codes are not recorded.
Power supply voltage error, or other errors	X	X	A3	<p>The muting inputs A and B are kept in the OFF state when the LOCKOUT state occurs due to the power supply voltage error. The power supply voltage may have dropped temporarily when the F3SG-SR is in operation. Check for temporary power supply voltage drop (by about 12 VDC) by the influence of the inductive load, etc. If the exclusive power supply is not used, check the power consumption of other connected devices for enough capacity.</p> <p>Power supply voltage may be outside the rated range. Connect the F3SG-SR to a 24 VDC<math>\pm</math>20% power supply voltage.</p> <p>Voltage fluctuation may have occurred due to insufficient power supply capacity. Replace the power supply with one that has a larger capacity.</p> <p>Instantaneous break or instantaneous stop may have occurred due to power sharing with other devices. Do not share the power supply with other devices. Connect the F3SG-SR to a power supply that is dedicated to electro-sensitive protective devices for electro-sensitive protective equipment such as the F3SG-SR, safety controller, etc.</p>
DIP Switch circuit error at startup	X	X	BC	The internal circuit may be defective. Replace the Intelligent Tap.
IO-Link circuit error	X	X	BD	The internal circuit may be defective. Replace the Intelligent Tap.
Internal error	X	X	Others	The internal circuit may be defective. Replace the Intelligent Tap.

\* You can check the error codes by SD Manager 3 or SD Manager 3 Mobile APP.

## Bluetooth® Communication Unit

See the following troubleshooting table to take measures if any of the phenomena in the table occurs when in the connection with the BluetoothR Communication Unit.

Status	Measures
Communications cannot be established	Check if Bluetooth® Communication Unit is properly mounted.
	Check if Bluetooth® function is enabled on the device you use for SD Manager 3.
	Check if Bluetooth® Communication Unit is not being paired with another device.
	Check if Bluetooth® Communication Unit and the device you use for SD Manager 3 are properly paired (or the connection is verified). *
	Check if Bluetooth® function of the device you use for SD Manager 3 supports SPP (Serial Port Profile).
	Check if a COM port is properly configured.
	Check the noise level in the environment.
	Check if there is any device that uses 2.4 GHz band.
	Check if there is any obstruction between Bluetooth® Communication Unit and the device you use for SD Manager 3. The maximum permissible line-of-sight distance is approximately 10 m.
	The F3SG-SR is under the SETTING state. Turn OFF and ON the power of the F3SG-SR.
Files cannot be read from the outside while the sensor is connected	The sensor model in the saved file does not match the sensor model in the file that you are about to read in. Check the sensor model.
	If a file is saved by SD Manager 3 of a newer version than your SD Manager 3, the file is not usable on your SD Manager 3. Check the SD Manager 3 version.
F3SG-SR does not go back to normal state after terminating SD Manager 3	Restart F3SG-SR. If SD Manager 3 does not operate normally even after restarted, use the setup recovery function to restore to the factory default settings again.

\* The procedure depends on the device you use for SD Manager 3. Refer to instruction manuals of the device.

## Related Manuals

Man.No.	Model	Manual Name
Z405	F3SG-□SR□□□□□□-□□-□□	Safety Light Curtain F3SG-□SR□ Series User's Manuals

- The Bluetooth® word mark and logo are registered trademarks and are owned by the Bluetooth SIG, Inc. and any use of such mark by OMRON Corporation is under license.
- USB Type-C™ is a trademark of USB Implementers Forum.
- The product photographs and figures that are used in this catalog may vary somewhat from the actual products.
- Other company names and product names in this document are the trademarks or registered trademarks of their respective companies.

# Terms and Conditions Agreement

## **Read and understand this catalog.**

Please read and understand this catalog before purchasing the products. Please consult your OMRON representative if you have any questions or comments.

## **Warranties.**

(a) Exclusive Warranty. Omron's exclusive warranty is that the Products will be free from defects in materials and workmanship for a period of twelve months from the date of sale by Omron (or such other period expressed in writing by Omron). Omron disclaims all other warranties, express or implied.

(b) Limitations. OMRON MAKES NO WARRANTY OR REPRESENTATION, EXPRESS OR IMPLIED, ABOUT NON-INFRINGEMENT, MERCHANTABILITY OR FITNESS FOR A PARTICULAR PURPOSE OF THE PRODUCTS. BUYER ACKNOWLEDGES THAT IT ALONE HAS DETERMINED THAT THE PRODUCTS WILL SUITABLY MEET THE REQUIREMENTS OF THEIR INTENDED USE.

Omron further disclaims all warranties and responsibility of any type for claims or expenses based on infringement by the Products or otherwise of any intellectual property right. (c) Buyer Remedy. Omron's sole obligation hereunder shall be, at Omron's election, to (i) replace (in the form originally shipped with Buyer responsible for labor charges for removal or replacement thereof) the non-complying Product, (ii) repair the non-complying Product, or (iii) repay or credit Buyer an amount equal to the purchase price of the non-complying Product; provided that in no event shall Omron be responsible for warranty, repair, indemnity or any other claims or expenses regarding the Products unless Omron's analysis confirms that the Products were properly handled, stored, installed and maintained and not subject to contamination, abuse, misuse or inappropriate modification. Return of any Products by Buyer must be approved in writing by Omron before shipment. Omron Companies shall not be liable for the suitability or unsuitability or the results from the use of Products in combination with any electrical or electronic components, circuits, system assemblies or any other materials or substances or environments. Any advice, recommendations or information given orally or in writing, are not to be construed as an amendment or addition to the above warranty.

See <http://www.omron.com/global/> or contact your Omron representative for published information.

## **Limitation on Liability; Etc.**

OMRON COMPANIES SHALL NOT BE LIABLE FOR SPECIAL, INDIRECT, INCIDENTAL, OR CONSEQUENTIAL DAMAGES, LOSS OF PROFITS OR PRODUCTION OR COMMERCIAL LOSS IN ANY WAY CONNECTED WITH THE PRODUCTS, WHETHER SUCH CLAIM IS BASED IN CONTRACT, WARRANTY, NEGLIGENCE OR STRICT LIABILITY.

Further, in no event shall liability of Omron Companies exceed the individual price of the Product on which liability is asserted.

## **Suitability of Use.**

Omron Companies shall not be responsible for conformity with any standards, codes or regulations which apply to the combination of the Product in the Buyer's application or use of the Product. At Buyer's request, Omron will provide applicable third party certification documents identifying ratings and limitations of use which apply to the Product. This information by itself is not sufficient for a complete determination of the suitability of the Product in combination with the end product, machine, system, or other application or use. Buyer shall be solely responsible for determining appropriateness of the particular Product with respect to Buyer's application, product or system. Buyer shall take application responsibility in all cases.

NEVER USE THE PRODUCT FOR AN APPLICATION INVOLVING SERIOUS RISK TO LIFE OR PROPERTY OR IN LARGE QUANTITIES WITHOUT ENSURING THAT THE SYSTEM AS A WHOLE HAS BEEN DESIGNED TO ADDRESS THE RISKS, AND THAT THE OMRON PRODUCT(S) IS PROPERLY RATED AND INSTALLED FOR THE INTENDED USE WITHIN THE OVERALL EQUIPMENT OR SYSTEM.

## **Programmable Products.**

Omron Companies shall not be responsible for the user's programming of a programmable Product, or any consequence thereof.

## **Performance Data.**

Data presented in Omron Company websites, catalogs and other materials is provided as a guide for the user in determining suitability and does not constitute a warranty. It may represent the result of Omron's test conditions, and the user must correlate it to actual application requirements. Actual performance is subject to the Omron's Warranty and Limitations of Liability.

## **Change in Specifications.**

Product specifications and accessories may be changed at any time based on improvements and other reasons. It is our practice to change part numbers when published ratings or features are changed, or when significant construction changes are made. However, some specifications of the Product may be changed without any notice. When in doubt, special part numbers may be assigned to fix or establish key specifications for your application. Please consult with your Omron's representative at any time to confirm actual specifications of purchased Product.

## **Errors and Omissions.**

Information presented by Omron Companies has been checked and is believed to be accurate; however, no responsibility is assumed for clerical, typographical or proofreading errors or omissions.

**Note : Do not use this document to operate the Unit.**

**OMRON Corporation Industrial Automation Company**  
Kyoto, JAPAN

**Contact: [www.ia.omron.com](http://www.ia.omron.com)**

**Regional Headquarters**

**OMRON EUROPE B.V.**

Wegalaan 67-69, 2132 JD Hoofddorp  
The Netherlands

Tel: (31)2356-81-300/Fax: (31)2356-81-388

**OMRON ELECTRONICS LLC**

2895 Greenspoint Parkway, Suite 200  
Hoffman Estates, IL 60169 U.S.A.

Tel: (1) 847-843-7900/Fax: (1) 847-843-7787

**OMRON ASIA PACIFIC PTE. LTD.**

No. 438A Alexandra Road # 05-05/08 (Lobby 2),  
Alexandra Technopark,  
Singapore 119967

Tel: (65) 6835-3011/Fax: (65) 6835-2711

**OMRON (CHINA) CO., LTD.**

Room 2211, Bank of China Tower,  
200 Yin Cheng Zhong Road,  
PuDong New Area, Shanghai, 200120, China

Tel: (86) 21-5037-2222/Fax: (86) 21-5037-2200

**Authorized Distributor:**

© OMRON Corporation 2018-2019 All Rights Reserved.  
In the interest of product improvement,  
specifications are subject to change without notice.

**CSM\_2\_1\_1219**  
**Cat. No. F105-E1-04**

1119(0818)